

70

Hatco
ANNIVERSARY
1950-2020





People who serve,
products that solve.®

How to Order

To ensure prompt and accurate processing of your order, please provide the following information:

1. Model number, voltage, Hertz and phase.
2. Specify options and accessories as required. Options are not retrofittable.
3. Consult factory when ordering equipment for special applications.
4. E-mail orders are acceptable and do not require confirmation.
5. See Resources section in back of book for more information.

ALL WATT RATINGS ARE NOMINAL. ACTUAL WATTAGE MAY VARY. CONSULT FACTORY FOR MORE INFORMATION.

E-mail orders to:
ordersindia@hatcocorp.com.

Technical Service Questions:
technicalserviceindia@hatcocorp.com

Parts and Equipment Questions:
customerserviceindia@hatcocorp.com

Hatco Foodservice Equipment India Private Limited

Hatco India registered office:
54- Deepak Building
13 - Nehru Place
New Delhi - 110019
India
GSTIN - 07AAFCH1234H1ZW

Warehouse/Customer Service Support +91-8870-920-999:
No 5/486-1, C Krishna Group Compound,
SIPCOT Post, Hosur,
Krishnagiri District,
Tamil Nadu, 635126,
India

www.hatcocorp.com

Who We Are

Since 1950, Hatco has been a leader in creating innovative ideas for the foodservice industry: bold innovations in equipment that improve efficiency, reliability and profits. Products are designed and built to handle the rugged demands of today's foodservice operations. Hatco is a company dedicated to exceptional customer service and quality engineered equipment offering maximum performance.

We Pride Ourselves On Being Employee Owned

The company was started by Gordon and LaReine Hatch in 1950 and was led by their son, David, beginning in 1990. In 2004, Hatco Corporation began the journey of employee ownership and in 2007, a monumental event in Hatco history occurred: the employees assumed 100% ownership from David Hatch! Hatco still remains a family corporation - only now our family is larger. The employee owners are driven by the spirit of ownership and motivated by the empowerment of ownership.

Equipment

Built-In Hot Shelves	Frost Tops	Hot Water Dispensers	Plate Warmer
Carving Stations	Fry Stations	Hot/Cold Shelves	Portable Holding Cabinet
Cold Shelves	Heated Display Cases	Ice Wells	Portable Food Warmers
Toasters	Heated Wells	Induction	Refrigerated Wells
Decorative Lamps	Holding & Display Cabinets	Salamanders	Strip Heaters
Display Lights	Merchandising Warmers	Mini Display Warmer	Waffle Makers
Drawer Warmers	Heated Air Curtains	Pizza Warmers	

Locations



Milwaukee - Corporate Office
635 South 28th Street | Milwaukee, WI 53215



Sturgeon Bay - Manufacturing Facility
208 East Deck Street | Sturgeon Bay, WI 54235



Let's Get Social



Table of Contents

TOASTERS	2-9	BUILT-INS	86-96
WELLS	10-40	DRAWER WARMERS	97-101
DECORATIVE LAMPS & DISPLAY LIGHTS	41-48	MERCHANDISERS	102-116
STRIP HEATERS	50-65	HOLDING & DISPLAY CABINETS	117-130
FRY STATION	66-70	INDUCTION	131-136
CARVING STATIONS	71-73	LIGHT COOKING	137-140
PORTABLES	74-85	SPECIALTY WATER EQUIPMENT	141-142

CDW.....	98	GRCMW	112	HWBI-S.....	22-23, 36-37
CLED	49	GRCSCL, GRCSCLH.....	73	HWBI-xQT	24-25, 31, 36-37
CSSBX, CSSBFX	87, 89	GRFF, GRFFL, GRFFB, GRFFBL... 67-68		HWBRT	24-25, 32, 36-37
CSUX	91	GRFHS	69-70	HWBRTQ	24-25, 33, 36-37
CSBFX	90	GRFS	69-70	HWBRT-43.....	24-25, 34, 36-37
CWBX, CWBX-S	13-16	GRH	54-55	HWBRT-xQT	24-25, 35-37
DCS	72	GRHD, GRHDH.....	115-116	HXMH, HXMH-xxD.....	108-109
DL	42-47	GRHW.....	83	HXMS, HXMS-xxD.....	108-109
FDWDE.....	119	GRS	81-82	IHDCH.....	124-125
FM-5	142	GRSB	95	IRNG.....	132-134
FS2HAC	130	GRSBF	96	ITQ	3
FSD	120-123	GRSDH, GRSDH-xxD	104-105	IWB, IWB-S.....	11-12, 16
FSDT	120-123	GRSDS, GRSDS-xxD	104-105	IWRM	135-136
FSHAC	130	GRSDS/H	103	MDW	126
FSHC-6W	128	GRSR	75	PWB, PWC	118
FSHC-7.....	129	GRSS	78	RCTHW.....	40
FSHC-EE.....	127	GRSSB	92	RCTWM	139
FTBX, FTBX-S.....	17-18	GRSSR	76-77	RHW.....	39
GM5AH.....	51	HBG	79	RMBs	64
GM5AHL.....	52-53	HBGB	93-94	SNACK	138
GMFFL	67	HBGBH	93-94	TK.....	9
GMHD, GMHDH.....	111	HCSBFX	89	TM	6
GR2BW	84-85	HCSSBX, HCSSBFX	88-89	TM3	5
GR2SDH, GR2SDH-xxD	106-107	HDW.....	99-101	TMS	140
GR2SDS, GR2SDS-xxD	106-107	HDW-xRx	99, 101	TPT.....	4
GR3SDS	110	HGSM.....	80	TQ	8
GRAH, GRAHL.....	54-55	HLC5	48	TQ3	7
GRAH-xxD, GRAHL-xxD.....	56-57	HW-FUL	38	UGAH, UGAHL	58, 60
GRAIH, GRAIH-xxD	61-62	HWB-FUL, HWBQ-FUL.....	24-28, 36-37	UGAH-xxD, UGAHL-xxD.....	59-60
GR-B.....	67-68	HWB-43	24-25, 29, 36-37	UGFF, UGFFL, UGFFB, UGFFBL... 67-68	
GRBW.....	84-85	HWB-xQT	24-25, 30, 36-37		
GRCD, GRCDH.....	113-114	HWBI, HWBI43.....	19-21, 36-37		

Toasters

*Buffets • Supermarkets & Delis • Restaurants & Cafés
Clubs & Bars • Catering • Concessions*



ITQ-1750-2C pg. 3



TPT-230-4 pg. 4



TM3-10H pg. 5



TQ3-500 pg. 7



TQ-800H pg. 8



TK-100 pg. 9

Intelligent Toast-Qwik®

Hatco's Intelligent Toast-Qwik® allows the operator to toast multiple products at the touch of the button, changing easily from bagels and toast to hash browns and garlic bread to crumpets and croissants, as well as melting cheese and finishing smaller food products. The unit can easily take the place of the current toasting platform and add versatility and future menu expansion along with energy efficiency and cost savings.

- The conveyor toaster can operate in four different modes:
 - ~ Continuous Through Put
 - ~ Select Single Item Mode
 - ~ In and Reverses Out Mode
 - ~ In, Pause, then Continues Through
- USB port located on the front allows for easy transfer of information such as program changes and product usage information
- The ability to program up to twenty product settings
- Hatco's patented ColorGuard Sensing System monitors and adjusts conveyor speed and temperature during high usage periods to ensure toast color uniformity
- Using Hatco's Spot-On® Technology, the toaster senses when product is placed on the conveyor and activates the unit
- Easy to clean, with removable crumb tray and collector ramp. There is minimal operator maintenance required, with self-cleaning elements and no maintenance motor and conveyor drives



HORIZONTAL CONVEYOR TOASTERS

Model	Dimensions (W x D x H)	Voltage	Watts	Amps	Capacity/Minute†	Ship Weight	List Price
ITQ-875-1C	370 x 727 x 420 mm	230	2700	11.8	15	41 kg	₹370052
ITQ-1000-1C*	450 x 727 x 457 mm	230	3600	15.7	17	40 kg	385317
ITQ-1750-2C*	513 x 728 x 470 mm	230	4960	21.6	30	48 kg	511342

† Toasting capacity may vary by product. Toasting of coated products not recommended.
* Cord without plug.

All Horizontal Conveyor Toaster Models Feature:
 Opening Dimensions – ITQ-875-1C: 154 W x 56 H mm.
 ITQ-1000-1C: 240 W x 51 H mm.
 ITQ-1750-2C: Two openings at 150 W x 56 H mm.
 Cord Location: Back of unit, lower left center.

ACCESSORIES (available for purchase at any time)

Paddle, with high temp, non-stick coating –		
ITQ1C-PAD	229 mm wide Food Paddle for ITQ-1000-1C model only	₹11289
ITQ2C-PAD	144 mm wide Food Paddle for ITQ-875-1C and ITQ-1750-2C models	8804
ITQ2CFEED175	Feed Ramp for ITQ-1750-2C model only	5254

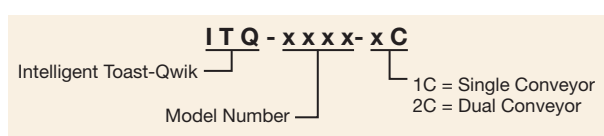

April 1, 2020

Pop-Up Toaster

Perfect for self-serve areas and light volume applications, the Hatco Pop-Up Toasters provide even golden toasting of a variety of bread products. The durable stainless steel housing contains four self-centering slots with individual toasting controls and removable crumb tray.

- Evenly toasts a variety of bread products including bagels, waffles and English muffins
- Four self-centering 32 mm wide slots
- A selector switch for single- (or double-) sided toasting

- Durable stainless steel construction
- Individual toasting controls
- Removable crumb tray for easy cleaning
- 1829 mm cord with plug



TPT-230-4

POP-UP TOASTER

Model	Dimensions W x D x H	Slot Opening W x D	Voltage Single Phase	Watts	Amps	Ship Weight	List Price
TPT-230-4	346 x 313 x 204 mm	32 x 140 mm	230	2388	10.4	8 kg	₹32163

The Pop-Up Model Features:

Cord Location: 1829 mm cord – back of unit, lower center.

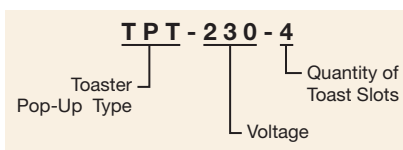

Toast-Max® Conveyor Toasters

The Toast-Max® Electric Conveyor Toaster is fast, reliable and versatile, toasting up to 350 bread or bun products per hour, depending on bread type. Featuring long-lasting serpentine metal sheathed heating elements and a permanently lubricated conveyor motor.

- Durable stainless steel construction
- ColorGuard Sensing System ensures toast color uniformity
- Powersave mode with indicator light saves energy during off-peak periods
- Allows for toasting bread products up to 76 mm thick
- Utilizing conveyor speed, not temperature, to determine toasting color, allows for instant adjustment of toasting time
- Units are shipped with 25 mm adjustable legs, feed ramp, removable crumb tray and a catch tray



TM3-10H in Designer Black, Designer Warm Red and Standard Stainless Steel

TOAST MAX CONVEYOR TOASTERS

Model	Dimensions W x D x H	Opening Dimensions W x H	Voltage Single Phase	Watts	Amps 50/60Hz	Capacity/ Hour†	Ship Weight	List Price
TM3-5H	290 x 535 x 412 mm	186 x 76 mm	230	1445	6.3	190-230	16 kg	₹64610
TM3-10H	368 x 535 x 411 mm	264 x 76 mm	230	2100	9.1	290-350	19 kg	84135

† Toasting capacity may vary by product. Toasting of coated products not recommended.

The Toast-Max Model Features:

Cord Location: Back of unit, lower right corner.

OPTIONS (available at time of purchase only)

Designer Colors – Non-standard colors are non-returnable – Stainless Steel Standard –

RED	Warm Red	No Charge
BLACK	Black	No Charge

ACCESSORIES

TM3-10-BUNFEED	Extended Feed Ramp for Buns (TM3-10H model only)	₹ 994
TM3-10-SECURITY	Control Cover and Bracket (TM3-10H model only)	2769

COLORS AND FINISHES – INSIDE BACK COVER

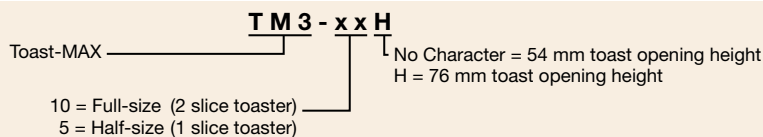



April 1, 2020

Toast-Max® Conveyor Toasters

Flexibility and performance are yours with Hatco's economical line of Toast-Max® Conveyor Toasters. Using conveyor speed, not temperature, to determine toasting color allows for instant adjustment of toasting time.

- Instant and precise adjustment of toast color with electronic infinite controls that regulate top and bottom heat
- Power Save Mode conserves energy
- Insulation and an interior fan provide cool surface temperatures
- Efficient design of front or rear discharge allows unit to be placed where it is most convenient for sending product to the operator side or to the customer/server side



TM-5H



TM-10H

TOAST-MAX CONVEYOR TOASTERS

Model	Dimensions W x D x H*	Opening Dimensions W x H	kW	Voltage Single Phase	Amps 50/60Hz	Capacity Per Minute†	Ship Weight	List Price
TM-5H	290 x 419 x 387 mm	186 x 88 mm	1.3-1.6	230	6.4	3 slices	16 kg	₹60989
TM-10H	368 x 419 x 387 mm	264 x 88 mm	1.9-2.3	230	9.2	6 slices	19 kg	67521

* Add 196 mm to depth if using tray extension in rear. Height includes legs.

† Toasting capacity may vary by product. Toasting of coated products not recommended.

All Toast-Max Models Feature:

Bread Types: Bread or buns.

Cord Location: 1829 mm on left side of back of unit near bottom.

TM - x x H
 Toast-Max ————
 5 = One Slice Wide ————
 10 = Two Slice Wide ————
 High Opening

Toast-Qwik® Conveyor Toasters

Hatco's industry-leading Toast-Qwik Toasters have been completely redesigned to provide a great new look, easy to use touchscreen controller, and increased production capabilities. They continue to provide the best reliability, flexibility, and value of any conveyor toaster available!

- Patented ColorGuard sensing system which monitors and adjusts conveyor speed to ensure consistent toast results - even in your busiest periods
- Dynamic new touchscreen controller that is easy to see and easier to use!
- Up to 12 programmable settings for precise and instant product changes
- USB port for easy uploads of program changes and software updates
- Unique new toast delivery ramp moves your product to the storage tray each and every time
- Crumb tray is removeable for easy cleaning
- 51 mm high opening Standard - 76 mm high opening on the TQ3-500H, -900H and -2000H models for thicker bread products



TQ3-500
shown in optional
Designer Warm Red



TQ3-900H
shown in optional
Stainless Steel



TQ3-2000
shown in standard
Designer Black

HORIZONTAL CONVEYOR TOASTERS

Model	Dimensions (W x D x H) <i>Height includes legs</i>	Opening Dimensions W x H	Voltage	Watts	Amps 50/60Hz	Capacity/ Minute†	Ship Weight	List Price
Toasts Two Slices Wide								
TQ3-500	374 x 524 x 435 mm	258 x 51 mm	220-230	2031-2220	9.2-9.7	7-8 slices	25 kg	₹180269
TQ3-500H	374 x 524 x 435 mm	258 x 76 mm	220-230	2031-2223	9.2-9.7	7-8 slices	25 kg	180269
TQ3-900	374 x 524 x 435 mm	258 x 51 mm	220-230	2763-3020	12.6-13.1	15 slices	25 kg	191842
TQ3-900H	374 x 524 x 435 mm	258 x 76 mm	220-230	2763-3020	12.6-13.1	15 slices	25 kg	191842
Toasts Three Slices Wide								
TQ3-2000*	475 x 536 x 436 mm	359 x 51 mm	220-230	3678-4020	16.7-17.5	33 slices	30 kg	₹228194
TQ3-2000H*	475 x 536 x 436 mm	359 x 76 mm	220-230	3678-4020	16.7-17.5	33 slices	30 kg	228194

† Toasting capacity may vary by product. Toasting of coated products not recommended.

* Cord without plug.

All Horizontal Conveyor Models Feature:

Cord Location: 1829 mm cord – lower right corner on back of unit.

OPTIONS (available at time of purchase only)

Designer Color Side Panels – Non-standard colors are non-returnable – Designer Black Standard –

SS	Stainless Steel	₹13987
WRED	Designer Warm Red	No Charge
SSINSERT	Stainless Steel toast tray insert (for TQ3-500 and -900 series only)	₹2840
TQ3-RAMP	Extended feed ramp in lieu of existing ramp - adds 76 mm	7100
TQ3-RAMP-XL	XL extended feed ramp in lieu of existing ramp - adds 229 mm (on TQ3-500 and -900 models only)	4077

COLORS AND FINISHES – INSIDE BACK COVER

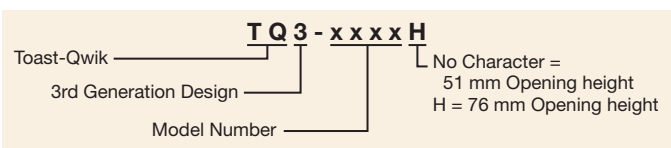



April 1, 2020

Toast-Qwik® Conveyor Toasters

Flexibility and performance are yours with Hatco's high capacity line of Toast-Qwik® Toasters. Using conveyor speed, not temperature, to determine toasting color allows for instant adjustment of toasting time. Toast-Qwik features the patented ColorGuard Sensing System for consistently toasted product.

- Instant and precise adjustment of toast color with electronic infinite controls that regulate top and bottom heat
- Optional Power Save Mode conserves energy
- Capacity of 400-1800 slices per hour, depending on bread type
- Opening height for H and HBA models is 76 mm, for all other models the opening height is 51 mm
- Insulation and an interior fan provide cool surface temperatures
- Efficient design of front or rear discharge allows unit to be placed where it is most convenient – for sending product to the operator side or to the customer/server side



TQ-400



TQ-1800

TOAST-QWIK CONVEYOR TOASTERS

Model	Dimensions W x D x H*	Opening Dimensions W x H	Voltage Single Phase	Watts	Amps 50/60Hz	Capacity/ Minute†	Ship Weight	List Price
TQ-400	368 x 451 x 378 mm	263 x 51 mm	220-230	1860-2030	8.5-8.8	6 slices	21 kg	₹160815
TQ-400BA ‡	368 x 451 x 378 mm	263 x 51 mm	220-230	1765-1930	8.0-8.4	6 slices	21 kg	160815
TQ-400H	368 x 451 x 403 mm	263 x 76 mm	220-230	2131-2330	9.7-10.0	6 slices	21 kg	160815
TQ-800	368 x 578 x 422 mm	265 x 51 mm	220-230	3019-3300	13.7-14.4	14 slices	29 kg	182825
TQ-800BA ‡	368 x 578 x 422 mm	265 x 51 mm	220-230	2791-3050	12.7-13.3	14 slices	28 kg	182825
TQ-800H	368 x 578 x 422 mm	265 x 76 mm	220-230	3019-3300	13.7-14.4	14 slices	28 kg	182825
TQ-800HBA ‡	368 x 578 x 422 mm	265 x 76 mm	220-230	2791-3050	12.7-13.3	14 slices	29 kg	182825
Toasts Three Slices Wide								
TQ-1800 §	470 x 577 x 421 mm	367 x 51 mm	220-230	3731-4078	17.0-17.7	30 slices	33 kg	₹229898
TQ-1800BA ‡§	470 x 577 x 421 mm	367 x 51 mm	220-230	3849-4206	17.5-18.3	30 slices	34 kg	229898
TQ-1800H §	470 x 577 x 421 mm	367 x 76 mm	220-230	3907-4271	17.8-18.6	30 slices	34 kg	229898
TQ-1800HBA ‡§	470 x 577 x 421 mm	367 x 76 mm	220-230	3849-4206	17.5-18.3	30 slices	34 kg	229898

• TQ-400, TQ-400BA and TQ-400H add 64 mm to depth if using tray extension in rear.

TQ-800, TQ-800BA, TQ-800H, TQ-800HBA, TQ-1800, TQ-1800BA, TQ-1800H and TQ-1800HBA, add 165 mm to depth if using tray extension in rear. Height includes legs.

† Toasting capacity may vary by product. Toasting of coated products not recommended.

‡ BA models toast one side only and are for bagels and buns, cut side up.

§ Cord without plug.

All Toast-Qwik Models Feature:

Cord Location: 1829 mm - back of unit, lower right side.

* Toasting capacity may vary by product. Toasting of coated products not recommended.

OPTIONS (available at time of purchase only)

TQ-PWR-A	Automatic Power Save Mode (Switches to Power Save Mode after 30 minutes of inactivity)	No Charge
-----------------	---	------------------

ACCESSORIES

TQRAMP	Extended Feed Guide adds 76 mm (excluding TQ-1800 models)	₹7171
TQ2-SECURITY	Control Cover and Bracket (excluding TQ-1800 models)	6674

**TQ-800BA with
accessory security
control cover**

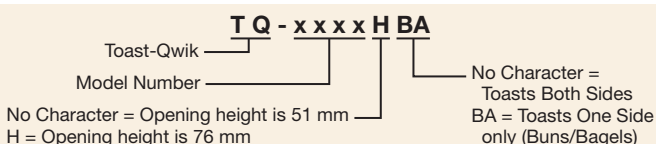

Toast King® Conveyor Toasters

Designed for mid- to high-volume and constant flow applications, Hatco's proven reliability and performance makes the TK toasters the workhorse of your operation. These toasters use conveyor speed, not temperature, to determine toast color.

- Toasts a variety of bread products
- Stainless steel construction for years of trouble-free service
- Power-saving thermostat for energy savings during non-peak times
- Manual advance and speed control
- Fully insulated for cooler operation
- Multiple metal sheathed toasting elements
- Toast storage area keeps bread warm and dry
- Capacity of 720-1320 slices per hour
- Three basket access for fast loading
- Top venting keeps heat away from the operator



TK-72



TK-135B

TOAST KING CONVEYOR TOASTERS

Model	Dimensions* W x D x H	Basket Size W x H	kW	Voltage Single Phase	Amps 50Hz	Capacity Per Minute†	Ship Weight	List Price
Bread or Buns								
TK-72	464 x 448 x 845 mm	254 x 117 mm	4.0	220	18.4	12 slices	33 kg	₹280521
TK-100	578 x 448 x 845 mm	368 x 117 mm	5.0	220	22.9	16 slices	40 kg	299904
Buns								
TK-135B	578 x 448 x 845 mm	368 x 117 mm	4.3	220	19.7	22 slices	40 kg	₹299904

*Width includes 19 mm for manual advance knob. Depth includes tray extension of 89 mm.

† Toasting capacity may vary by product. Toasting of coated products not recommended.

All Toast King Models Feature:

Maximum Product Thickness: 32 mm.

Cord Location: 1219 mm Cord – Back of unit, lower left side.

OPTIONS (available at time of purchase only)

TK-SECURITY	Control Cover, Bracket, Mounting Hardware and Fuse Cover	₹12709
--------------------	--	--------

ACCESSORIES

4"LEGS	102 mm Adjustable Legs (4)	₹3337
---------------	----------------------------	-------

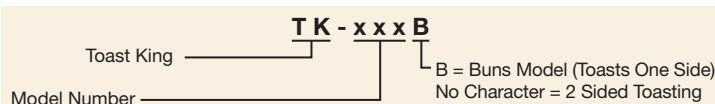

Wells

Cafeterias • Buffets
Convenience Stores • Supermarkets & Delis
Restaurants & Cafés • Clubs & Bars



IWB-6 with accessory food pan (sneeze guards and bowls not available) *pg. 11*



CWBX-5 with accessory food pans and pan support bars *pg. 14*



CWBX-S4 with optional **CWB-S4SLANT**, accessory pan support bars and food pans *pg. 15*



FTBX-2 with accessory full-size sheet pans *pg. 18*



HWBI-3MA with accessory food pans *pg. 20*



HWBI-2 with accessory half- and third-size food pans (sneeze guards not available) *pg. 20*



HWBI-S4MA with accessory food pans (shown with **GRAH-72**, sneeze guards not available) *pg. 23*



HWBRT-70TD and **HWBRT-110TD** with accessory food pans and mounting kit (also shown **HWB-43D**, **HWBI-FULD** and **GR2AHL** with standard *Designer* non-adjustable stands and optional *Designer* color and sneeze guards) *pg. 26 -35*



HW-FUL with accessory pan support bars (food pans, ladles and lids not available) *pg. 38*

Drop-In Ice Wells

Hatco Drop-In Ice Wells provide all the quality features of our Refrigerated Drop-Ins, but without any refrigeration or electrical components. These ice-cooled, insulated units can hold pre-chilled food products at preferred serving temperatures. Ideal for salad bars, cold buffets and chilled beverage bars. Pan dividers give you greater flexibility in your variety of featured food products.

- Full-size, insulated, top mount wells available to hold 1- to 6-pan configurations
- Optimal insulation on sides and bottom to ensure better cold retention and cost savings

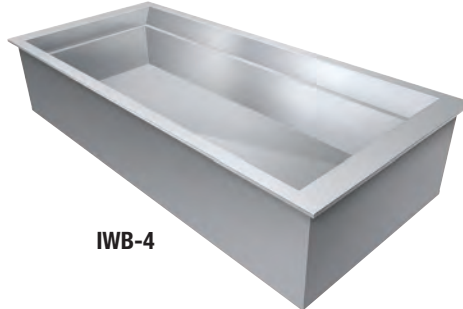

IWB-4

- Bezel design allows clear viewing and easy food access
- 1" NPT brass drain with flat screen simplifies cleaning
- False bottom accessory conveniently holds ice above drain for ease of draining
- Matches the Hatco line of Wells for a fully integrated look

IWB-2 with slant option IWB-2SLANT

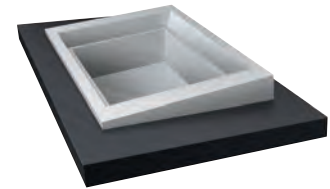

Slant Option for:
IWB-1, -2, -3, -4, -5, -6

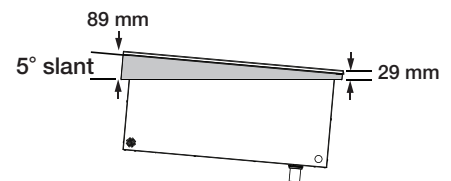

False Bottom Accessories

1-part, 2-part or 3 part(s) depending on pan size

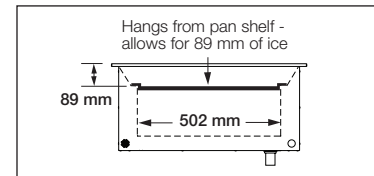

(1, 2, 3, 4, 5 or 6FB3.5) allows 89 mm of ice

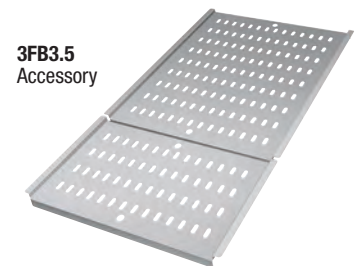

3FB3.5
Accessory

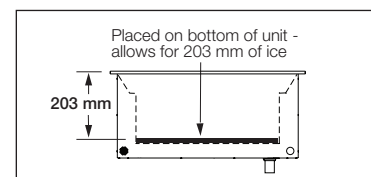

(1, 2, 3, 4, 5 or 6FB8) allows 203 mm of ice

2FB8 Accessory

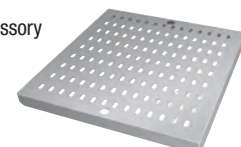

DROP-IN INSULATED ICE WELLS

Model	Dimensions W x D x H	Ship Weight†	List Price
IWB-1	483 x 686 x 305 mm	29 kg	₹ 96844
IWB-2	813 x 686 x 305 mm	38 kg	111612
IWB-3	1143 x 686 x 305 mm	47 kg	129291
IWB-4	1473 x 686 x 305 mm	66 kg	149881
IWB-5	1803 x 686 x 305 mm	50 kg	173382
IWB-6	2134 x 686 x 305 mm	82 kg	199794

† Shipping weights are approximate.

OPTIONS (available at time of purchase only)

IWB-1SLANT	Slant Option for IWB-1	₹14200
IWB-2SLANT	Slant Option for IWB-2	15336
IWB-3SLANT	Slant Option for IWB-3	16543
IWB-4SLANT	Slant Option for IWB-4	17679
IWB-5SLANT	Slant Option for IWB-5	18886
IWB-6SLANT	Slant Option for IWB-6	20022

ACCESSORIES (available for purchase at any time)

False Bottoms (allows for 89 mm of ice and sits on ledge of well) –

1FB3.5	For IWB-1 models (includes one 1-pan Insert)	₹ 5325
2FB3.5	For IWB-2 models (includes one 2-pan Insert)	9798
3FB3.5	For IWB-3 models (includes one 1-pan Insert and one 2-pan Insert)	14271
4FB3.5	For IWB-4 models (includes two 2-pan Insert)	18744
5FB3.5	For IWB-5 models (includes one 1-pan Insert and two 2-pan Inserts)	23217
6FB3.5	For IWB-6 models (includes three 2-pan Inserts)	27690

False Bottoms (allows for 203 mm of ice and sits on bottom of well) –

1FB8	For IWB-1 models (includes one 1-pan Insert)	₹ 5325
2FB8	For IWB-2 models (includes one 2-pan Insert)	9798
3FB8	For IWB-3 models (includes one 1-pan Insert and one 2-pan Insert)	14271
4FB8	For IWB-4 models (includes two 2-pan Insert)	18744
5FB8	For IWB-5 models (includes one 1-pan Insert and two 2-pan Inserts)	23217
6FB8	For IWB-6 models (includes three 2-pan Inserts)	27690

ADDITIONAL PANS AND SUPPORT BAR ACCESSORIES – PAGE 16

DROP-IN ICE WELL COUNTERTOP CUT-OUTS

Model	Minimum Width	Maximum Width	Minimum Depth	Maximum Depth
IWB-1	435 mm	457 mm	640 mm	660 mm
IWB-2	765 mm	787 mm	640 mm	660 mm
IWB-3	1095 mm	1118 mm	640 mm	660 mm
IWB-4	1426 mm	1448 mm	640 mm	660 mm
IWB-5	1756 mm	1778 mm	640 mm	660 mm
IWB-6	2086 mm	2108 mm	640 mm	660 mm

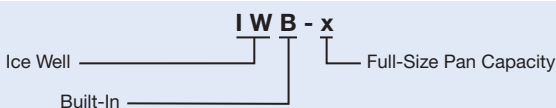

Drop-In Slim Ice Wells

Hatco Drop-In Slim Ice Wells provide all the quality features of our Refrigerated Drop-Ins, but without any refrigeration or electrical components. Now available in a slim configuration providing customers with a complete well within easy reach, regardless of the sneeze guards.

Ideal for salad bars, cold buffets and chilled beverage bars. Pan dividers give you greater flexibility in your variety of featured food products.

- Holds 1- to 4-full-size pan configurations, but placed lengthwise
- Optimal insulation on sides and bottom to ensure better cold retention and cost savings
- Bezel design allows clear viewing and easy food access
- 1" NPT brass drain with flat screen simplifies cleaning
- False bottom accessory conveniently holds ice above drain for ease of draining
- Matches the Hatco line of Wells for a fully integrated look



DROP-IN INSULATED SLIM ICE WELLS

Model	Dimensions W x D x H	Ship Weight†	List Price
IWB-S1	687 x 481 x 306 mm	22 kg	₹100536
IWB-S2	1222 x 481 x 306 mm	48 kg	115304
IWB-S3	1757 x 481 x 306 mm	40 kg	132983
IWB-S4	2292 x 481 x 306 mm	92 kg	153573

† Shipping weights are approximate.

OPTIONS (available at time of purchase only)

IWB-S1SLANT	Slant Option for IWB-S1	₹14200
IWB-S2SLANT	Slant Option for IWB-S2	15336
IWB-S3SLANT	Slant Option for IWB-S3	16543
IWB-S4SLANT	Slant Option for IWB-S4	17679

ACCESSORIES (available for purchase at any time)

False Bottoms (allows for 89 mm of ice and sits on ledge of well) –

1FBS3.5	For IWB-S1 models (includes one 1-pan Insert)	₹ 5325
2FBS3.5	For IWB-S2 models (includes one 2-pan Insert)	9798
3FBS3.5	For IWB-S3 models (includes one 1-pan Insert and one 2-pan Insert)	14271
4FBS3.5	For IWB-S4 models (includes two 2-pan Insert)	18744

False Bottoms (allows for 203 mm of ice and sits on bottom of well) –

1FBS8	For IWB-S1 models (includes one 1-pan Insert)	₹ 5325
2FBS8	For IWB-S2 models (includes one 2-pan Insert)	9798
3FBS8	For IWB-S3 models (includes one 1-pan Insert and one 2-pan Insert)	14271
4FBS8	For IWB-S4 models (includes two 2-pan Insert)	18744

ADDITIONAL PANS AND SUPPORT BAR ACCESSORIES – PAGE 16

DROP-IN SLIM ICE WELLS COUNTERTOP CUT-OUTS

Model	Minimum Width	Maximum Width	Minimum Depth	Maximum Depth
IWB-S1	641 mm	662 mm	433 mm	456 mm
IWB-S2	1175 mm	1196 mm	433 mm	456 mm
IWB-S3	1710 mm	1731 mm	433 mm	456 mm
IWB-S4	2245 mm	2266 mm	433 mm	456 mm

Slant Option for:
IWB-S1, -S2, -S3, -S4

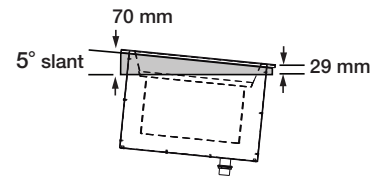

False Bottom Accessories
1-, 2- or 3-part(s) depending on pan size

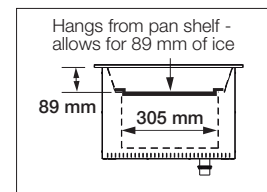

(1, 2, 3 or 4FBS3.5) allows
89 mm of ice

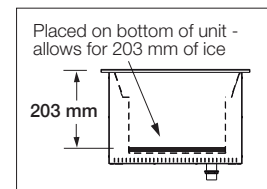

(1, 2, 3 or 4FBS8) allows
203 mm of ice

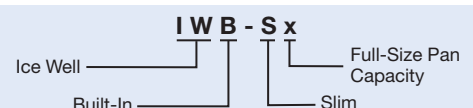

Remote Refrigerated Drop-In Wells Ordering Instructions

Cutaway of **CWBX-6**
with accessory food pans

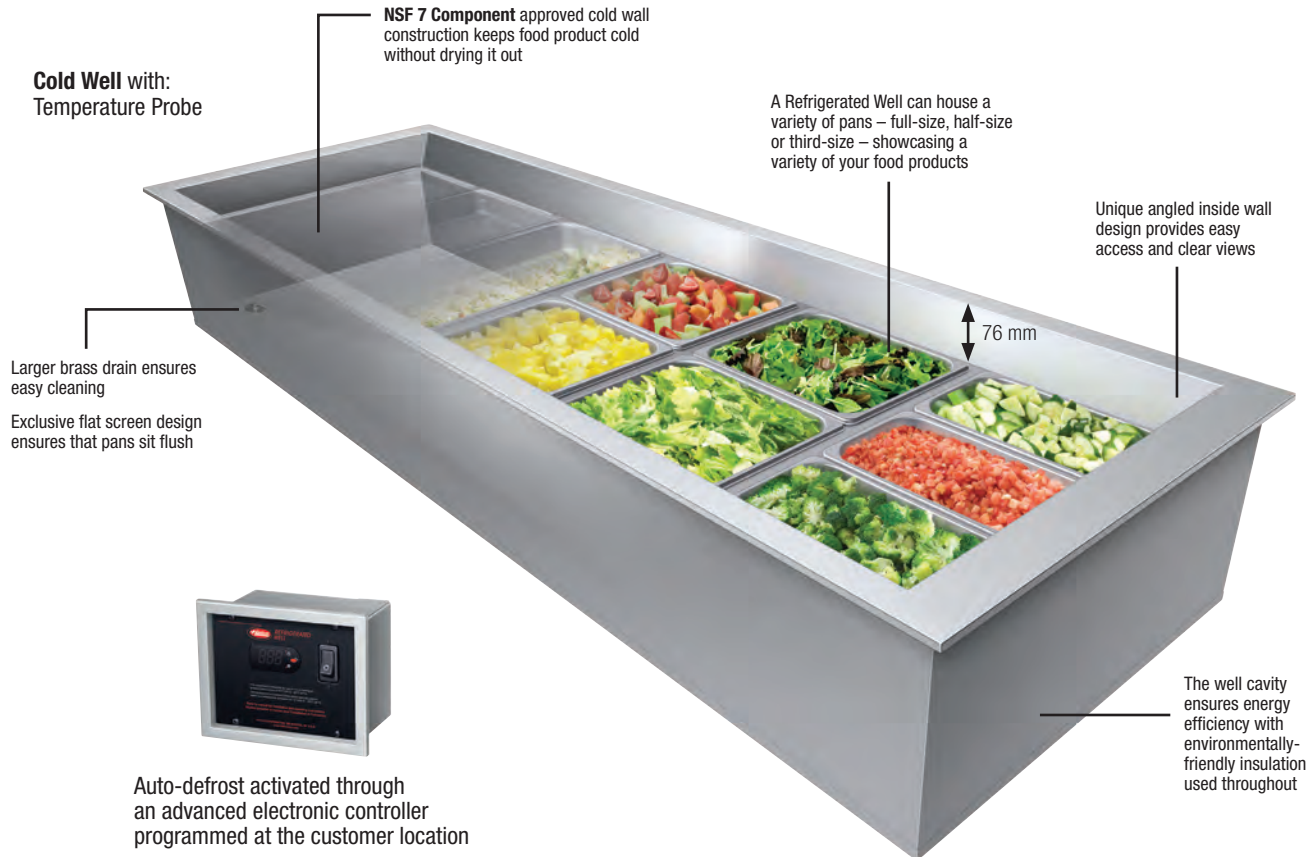

Wells

Please specify the following with each order:

- Desired Voltage:**
220-240V
- Number of Drop-In Wells Required:**
 - Standard configuration
1-, 2-, 3-, 4-, 5-, 6-pan as rectangular,
full-size (305 mm x 508 mm)
 - Slim configuration
S1-, S2-, S3-, S4-pan as rectangular,
full-size (508 mm x 305 mm)
- Depth of Model:** Standard configuration 686 mm
or Slim configuration 481 mm
- Remote Refrigeration**
NOTE: Shipped loose: Cold Well
with Temperature Probe, Control Panel
(Probe Wires are 4.9 meters) and
a TXV Valve

Option

- Slant Option for CWBX-1, -2, -3, -4, -5 or
CWBX-6 or -S1, -S2, -S3, -S4

Accessories

- Pan Support Bars:** 305 mm x 508 mm
- Stainless Steel Pans:**
 - Third-size at 64 mm deep
(324 W x 175 D x 64 H mm)
 - Half-size at 64 mm deep
(324 W x 264 D x 64 H mm)
 - Full-size at 64 mm deep
(324 W x 527 D x 64 H mm)
 - Full-size at 102 mm deep
(324 W x 527 D x 102 H mm)
 - Full-size at 152 mm deep
(324 W x 527 D x 152 H mm)

3. Perforated False Bottom

4. Trivets:

- Half-size
259 W x 194 D mm
- Full-size
259 W x 457 D mm

ACCESSORIES – PAGES 36-37

The greater surface area
of the angled wall and
the placement of the
coils allow cold air to
more effectively blanket
your food product



REMOTE REFRIGERATED DROP-IN WELLS COUNTERTOP CUT-OUTS

Model	Minimum Width	Maximum Width	Minimum Depth	Maximum Depth
CWBX-1	435 mm	457 mm	640 mm	660 mm
CWBX-2	765 mm	787 mm	640 mm	660 mm
CWBX-3	1095 mm	1118 mm	640 mm	660 mm
CWBX-4	1426 mm	1448 mm	640 mm	660 mm
CWBX-5	1756 mm	1778 mm	640 mm	660 mm
CWBX-6	2086 mm	2108 mm	640 mm	660 mm
Slim Series				
CWBX-S1	641 mm	662 mm	433 mm	456 mm
CWBX-S2	1175 mm	1196 mm	433 mm	456 mm
CWBX-S3	1710 mm	1731 mm	433 mm	456 mm
CWBX-S4	2245 mm	2266 mm	433 mm	456 mm



Remote Refrigerated Drop-In Wells

Hatco's Remote Refrigerated Drop-In Wells keep pre-chilled food products at safe-serving temperatures but in a remote configuration that offers unlimited flexibility for your own particular dining design needs.

- Full-size, insulated Wells available in 1- to 6-pan configurations
- NSF 7 Component approved cold wall construction keeps food cold without drying it out
- Optimal insulation on sides and bottom to ensure better cold retention. Environmentally-friendly insulation used throughout
- Models include a control panel (shipped loose - probe wires are 4.9 meters) but without a condensing unit for the increased flexibility of multiple cold well configurations
- Auto-defrost is activated through an advanced electronic controller programmed at the customer location
- 1" NPT brass drain simplifies cleaning



Control panel (shipped loose)

CWBX-6 with accessory food pans and pan support bars (shipped without condensing unit)

REMOTE REFRIGERATED DROP-IN FULL-SIZE MODELS – WITH REMOTE CONTROL PANEL

Model	Dimensions W x D x H	List Price
CWBX-1	483 x 686 x 433 mm	₹260144
CWBX-2	813 x 686 x 433 mm	284497
CWBX-3	1143 x 686 x 433 mm	313607
CWBX-4	1473 x 686 x 433 mm	331783
CWBX-5	1803 x 686 x 433 mm	357982
CWBX-6	2134 x 686 x 433 mm	387660

All Remote Refrigerated Drop-In Well Models with Remote Control Panel Feature:

Voltage: 220-240V, single phase.

Models Shipped with: Electronic temperature control, TXV valve (shipped loose) and a solenoid valve attached to well.

OPTIONS (available at time of purchase only)

CWBR-1SLANT	Slant Option for CWBX-1	₹14200
CWBR-2SLANT	Slant Option for CWBX-2	15336
CWBR-3SLANT	Slant Option for CWBX-3	16543
CWBR-4SLANT	Slant Option for CWBX-4	17679
CWBR-5SLANT	Slant Option for CWBX-5	18886
CWBR-6SLANT	Slant Option for CWBX-6	20022

CWBX-2 with slant option
CWBR-2SLANT

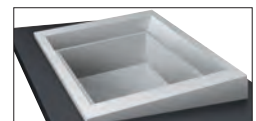

Slant Option for:
CWBX-1, -2, -3, -4, -5, -6

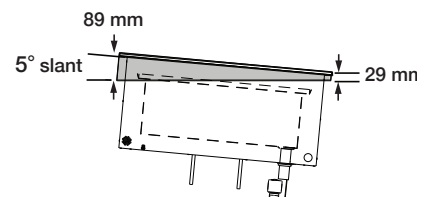

COUNTERTOP CUT-OUT DIMENSIONS – PAGE 13 ACCESSORIES – PAGES 16



Remote Refrigerated Slim Drop-In Wells

Hatco's Remote Refrigerated Slim Drop-In Well is a full-size unit that blankets your pre-chilled food product to retain optimum freshness and taste in one efficient and easy operation – but placed lengthwise and in two remote configurations. This provides customers with a complete cold well within easy reach, regardless of the sneeze guards and unlimited flexibility for your design needs.

- Full-size, Insulated wells available in 1 to 4 full-size pan configurations
- NSF 7 Component approved cold wall construction keeps food cold without drying it out
- Optimal insulation on sides and bottom to ensure better cold retention. Environmentally-friendly insulation used throughout
- Models include a control panel (shipped loose - probe wires are 4.9 meters) but without a condensing unit for the increased flexibility of multiple cold well configurations
- Auto-defrost is activated through an advanced electronic controller programmed at customer location
- 1" NPT brass drain simplifies cleaning



CWBX-S4 with accessory (hotel) food pans and additional support bars

Control panel (Shipped loose)

REMOTE REFRIGERATED SLIM DROP-IN FULL-SIZE MODELS – WITH REMOTE CONTROL PANEL

Model	Dimensions (W x D x H)	List Price
CWBX-S1	687 x 481 x 435 mm	₹260144
CWBX-S2	1222 x 481 x 435 mm	296141
CWBX-S3	1757 x 481 x 435 mm	359189
CWBX-S4	2292 x 481 x 435 mm	443537

All Remote Refrigerated Slim Drop-In Well Models with Remote Control Panel Feature:

Voltage: 220-240V, single phase.

Models Shipped with: Electronic temperature control, TXV valve (all shipped loose) and a soleoid valve attached to the well.

OPTIONS (available at time of purchase only)

CWB-S1SLANT	Slant Option for CWBX-S1	₹15620
CWB-S2SLANT	Slant Option for CWBX-S2	16827
CWB-S3SLANT	Slant Option for CWBX-S3	17963
CWB-S4SLANT	Slant Option for CWBX-S4	19170

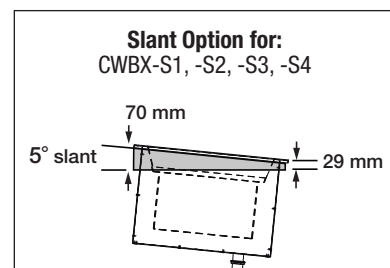

COUNTERTOP CUT-OUT DIMENSIONS – PAGE 13 ACCESSORIES – PAGES 16

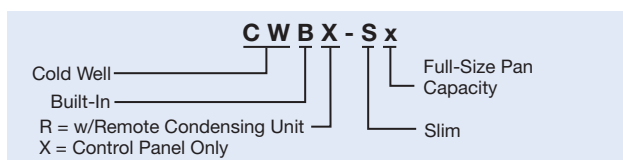

Refrigerated Drop-In Well Accessories *(available for purchase at any time)*



CWB-2 with optional CWB-2SLANT and accessory food pans and pan support bars

PANS – TRIVETS

ST PAN 1/3	Third-Size Stainless Steel Pan – 324 W x 175 D x 64 H mm	₹3550
ST PAN 1/2	Half-Size Stainless Steel Pan – 324 W x 264 D x 64 H mm	3976
ST PAN 2	Full-Size Stainless Steel Pan – 324 W x 527 D x 64 H mm	4828
ST PAN 4	Full-Size Stainless Steel Pan – 324 W x 527 D x 102 H mm	6106
HDW 6" PAN	Full-Size Stainless Steel Pan – 324 W x 527 D x 152 H mm	6674
Wire Trivets Stainless –		
TRIVET (1/2)SS	Half-Size – 259 W x 194 D mm	₹ 6674
TRIVET SS	Full-Size – 259 W x 457 D mm	9088

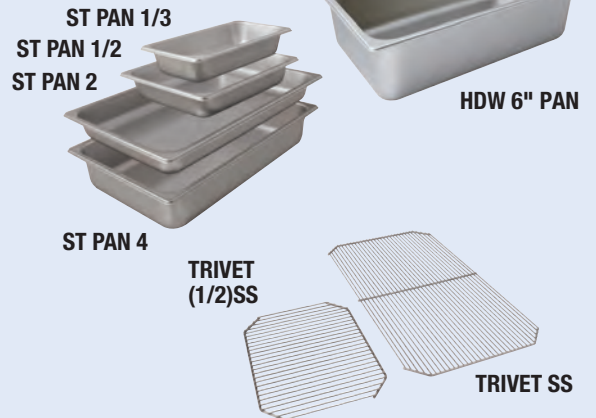

SUPPORT BARS – FALSE BOTTOMS

CWB12BAR	305 mm Pan Support Bar for Drop-In Ice or Refrigerated Wells	₹1136
CWB20BAR	508 mm Pan Support Bar for Drop-In Ice or Refrigerated Wells	1349
False Bottom for Drop-In Refrigerated Wells (Perforated False Bottom Accessory, choose your appropriate pan size) –		
CWB-1FB	For CWB-1 (1-Part Accessory)	₹ 5325
CWB-2FB	For CWB-2 (1-Part Accessory)	9798
CWB-3FB	For CWB-3 (2-Part Accessory)	14271
CWB-4FB	For CWB-4 (2-Part Accessory)	18744
CWB-5FB	For CWB-5 (3-Part Accessory)	23217
CWB-6FB	For CWB-6 (3-Part Accessory)	27690
False Bottom for Slim Refrigerated Wells (choose your appropriate pan size) –		
1FBS8	For CWB-S1 (1-Part Accessory)	₹ 5325
2FBS8	For CWB-S2 (1-Part Accessory)	9798
3FBS8	For CWB-S3 (2-Part Accessory)	14271
4FBS8	For CWB-S4 (2-Part Accessory)	18744

Support Bars
Choose the appropriate kit for IWB or CWB series

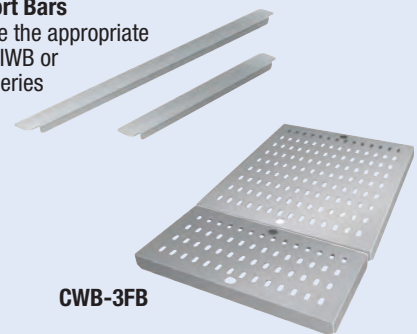

False Bottom Accessories
1-part, 2- or 3-part(s) depending on pan size

(CWB-1, -2, -3, -4, -5 or -6FB)
for the CWBX series

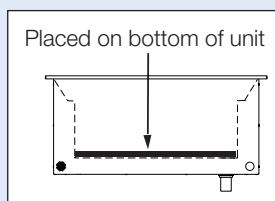

(1, 2, 3, or 4FBS8)
for the CWBX-S series

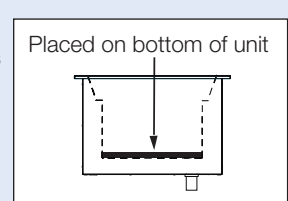

Remote Drop-In Frost Tops Ordering Instructions

Wells

Cutaway of **FTBX-3**
with accessory sheet pans

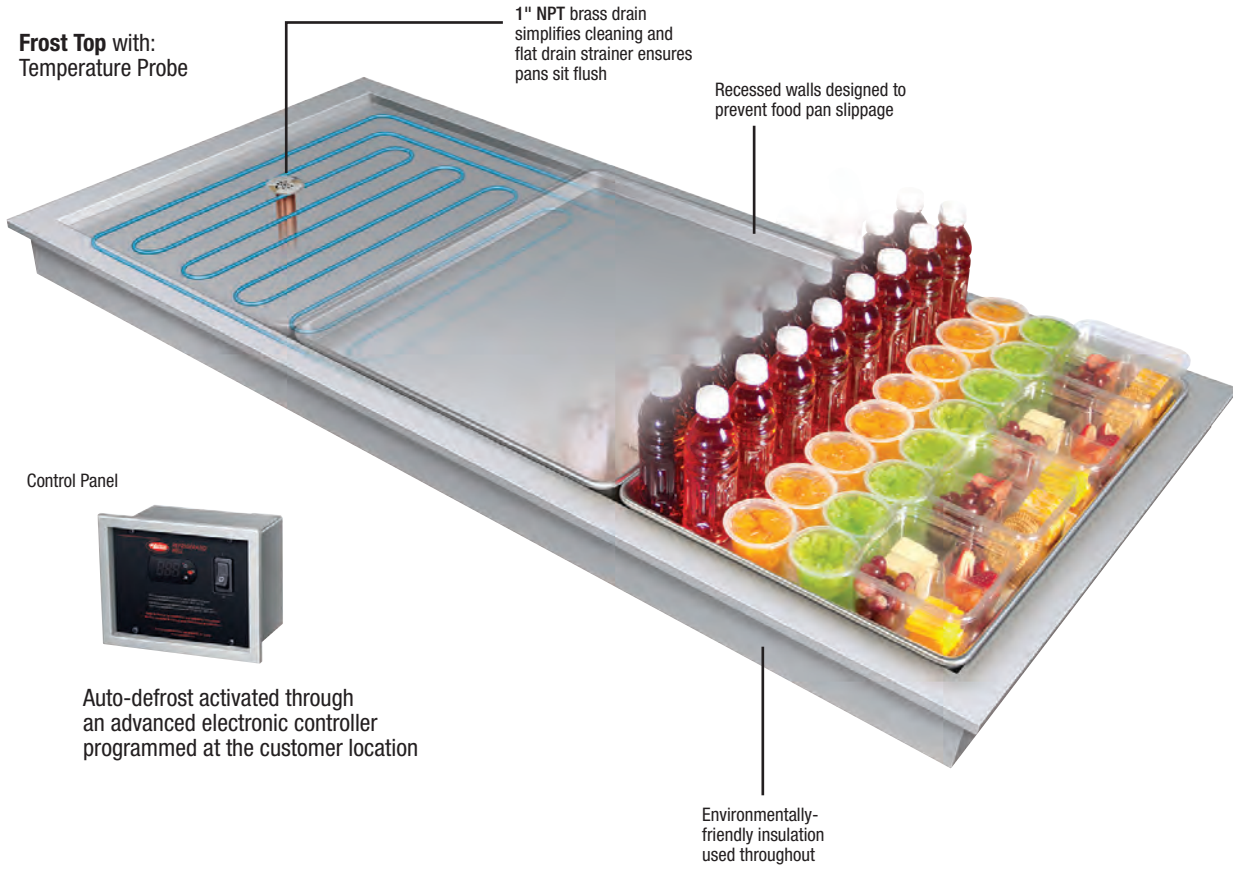

Please specify the following with each order:

1. **Desired Voltage:**
220-240V
2. **Number of Full-Size Sheet Pans Accommodated:**
1-, 2- or 3-pan as rectangular sheet pans
3. **Depth of Model:** Standard configuration (735 mm D) or Slim configuration (535 mm D)
4. **Remote Refrigeration**
Note: Shipped loose: Frost Top, Control Panel (Probe Wires are 4.9 meters) and a TXV Valve
 A. FTBX without a Condensing Unit
 (Solenoid Valve attached to Frost Top)

Accessories

1. **Pans –**
 - A. Half-size sheet pan
457 W x 330 D mm
 - B. Full-size sheet pan
457 W x 660 D mm

NSF 7 Component approved cold wall construction keeps food product cold without drying it out

REMOTE DROP-IN FROST TOP COUNTERTOP CUT-OUTS

Model	Minimum Width	Maximum Width	Minimum Depth	Maximum Depth
FTBX-1	697 mm	711 mm	494 mm	511 mm
FTBX-2	949 mm	965 mm	694 mm	711 mm
FTBX-3	1407 mm	1422 mm	694 mm	711 mm
FTBX-S2	1354 mm	1372 mm	494 mm	511 mm
FTBX-S3	2011 mm	2029 mm	494 mm	511 mm

Remote Drop-In Frost Tops

Keeping pre-chilled beverages, snacks, hors d'oeuvres and side dishes cool and ready-to-serve, the Hatco Remote Drop-In Frost Tops offer additional flexibility with remote configurations. Also available in a slim configuration that provides customers with a Frost Top within easy reach, regardless of the sneeze guards.

- Accommodates full-size sheet pans
- Additionally the FTBX-2 and -3 models include a standard 1" NPT brass drain
- Models include a control panel (shipped loose - probe wires are 4.9 meters) but shipped without a condensing unit for the increased flexibility of multiple Frost Top configurations
- Auto-defrost is activated through an advanced electronic controller programmed at the customer location
- Optimal insulation on sides and bottom to ensure better cold retention



FTBX-S2 with accessory sheet pans (shipped without condensing unit)

REMOTE DROP-IN FROST TOPS – WITH CONTROL PANEL

Model	Dimensions W x D x H	List Price
FTBX-1	735 x 535 x 219 mm	₹281302
FTBX-2	991 x 735 x 219 mm	326032
FTBX-3	1448 x 735 x 219 mm	375661

All Remote Drop-In Frost Tops with Control Panel Feature:

Models Shipped with: Electronic temperature control, TXV valve (shipped loose) and a solenoid valve attached to bottom of unit.

REMOTE SLIM DROP-IN FROST TOPS – WITH CONTROL PANEL

Model	Dimensions W x D x H	List Price
FTBX-S2	1395 x 535 x 219 mm	₹330505
FTBX-S3	2053 x 535 x 219 mm	383400

All Remote Slim Drop-In Frost Tops with Control Panel Feature:

Models Shipped with: Electronic temperature control, TXV valve (shipped loose) and a solenoid valve attached to bottom of unit.

ACCESSORIES (available for purchase at any time)

ALUM PAN	Half-Size Sheet Pan – 457 W x 330 D mm	₹1988
18" SHEET PAN	Full-Size Sheet Pan – 457 W x 660 D mm	2769

COUNTERTOP CUT-OUT DIMENSIONS – PAGE 17

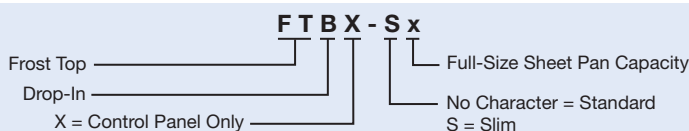

Modular/Ganged Heated Wells (Full and 4/3-Size) Ordering Instructions

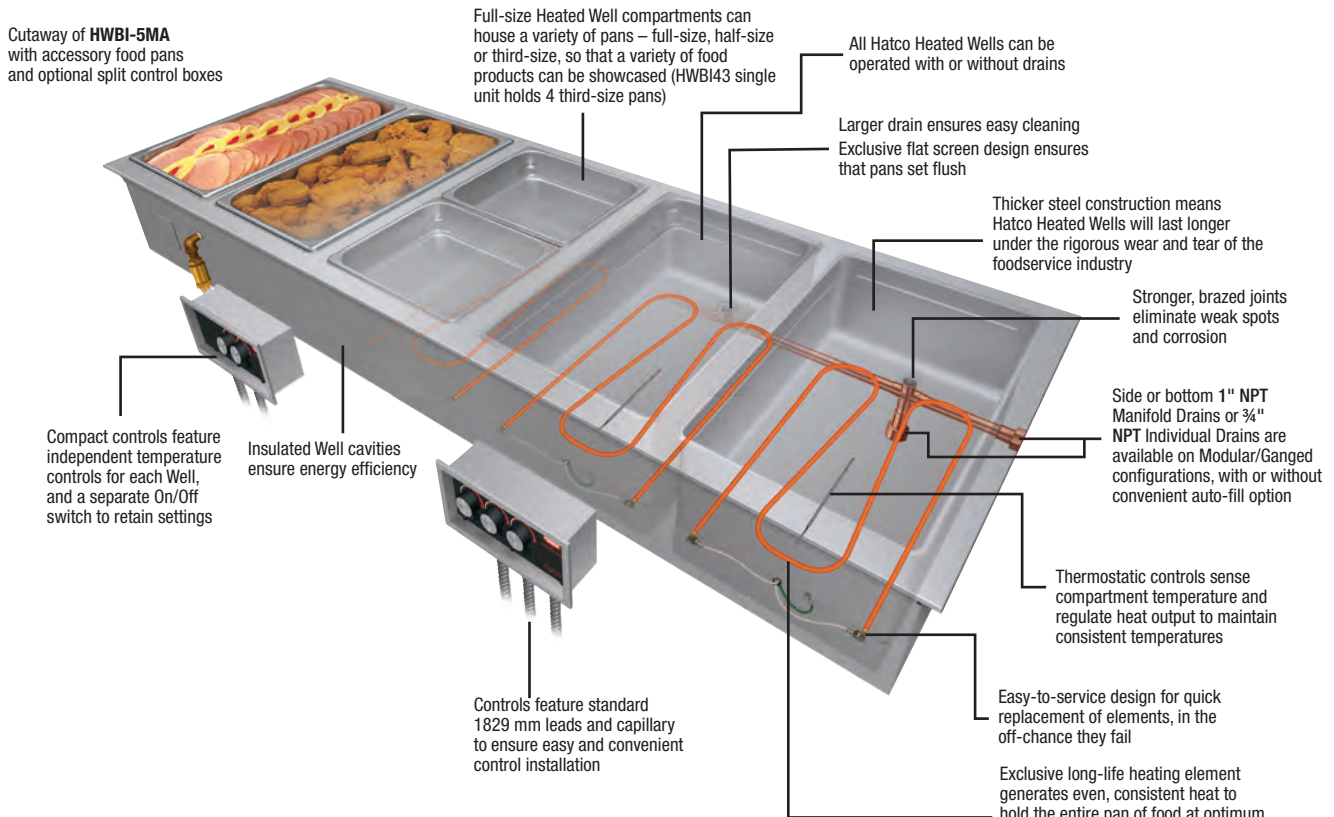

Please specify the following with each order:

1. **Desired Voltage:** 220V
2. **Number of Modular/Ganged Heated Wells Required:** 1-, 2-, 3-, 4-, 5- or 6-pan
NOTE: Modular/Ganged units are only offered as rectangular, full-size (305 x 508 mm) or as 4/3-size wells (305 x 686 mm)
3. **Drain** (with or without – choose drain below):
 A. Standard Individual Well 3/4" NPT Drain
 B. Manifold 1" NPT Drain with side drain, field selectable left or right side (available on -2, -3, -4, -5, -6 models only)
 C. Manifold 1" NPT Drain with bottom drain, field selectable left or right well (available on -2, -3, -4, -5, -6 models only)
4. **Auto-fill** (with or without)
5. **Bezel** allows a 686 mm depth for Modular units to match Hatco CWBX models in a countertop display (not available for HWBI43 Series)
6. **Control:**
 A. Single Control Box (standard on all units)
 B. Split Control Boxes (optional on 4-, 5-, 6-pan units and must be specified at order, not available on 1-, 2-, 3-Pan units)

Accessories for Modular/Ganged Heated Wells

1. **Pan Support Bars:**
 A. Standard or Slim configuration 305 or 508 mm
 B. 4/3-size configuration 305 mm
2. **Adapters:** to convert Modular/Ganged units to hold round pans:
 A. Standard or Slim configuration 4- to 7-liter round pans
 B. 4/3-size configuration 10-liter round pans
3. **Stainless Steel Pans:**
 A. Third-size at 64 mm high (324 W x 175 D x 64 H mm)
 B. Half-size at 64 mm high (324 W x 264 D x 64 H mm)
 C. Full-size at 64 mm high (324 W x 527 D x 64 H mm)
 D. Full-size at 102 mm high (324 W x 527 D x 102 H mm)
 E. Full-size at 152 mm high (324 W x 527 D x 152 H mm)
4. **Valves:**
 1" or 3/4" NPT Ball Valve
 1" or 3/4" NPT Gate Valve

ACCESSORIES – PAGES 36-37

DROP-IN MODULAR/GANGED HEATED WELLS COUNTERTOP CUTOUTS

Model	Minimum Width	Maximum Width	Minimum Depth	Maximum Depth
HWBI-1 Series	359 mm	368 mm	565 mm	575 mm
HWBI-2 Series	715 mm	724 mm	565 mm	575 mm
HWBI-3 Series	1070 mm	1080 mm	565 mm	575 mm
HWBI-4 Series	1426 mm	1435 mm	565 mm	575 mm
HWBI-5 Series	1781 mm	1791 mm	565 mm	575 mm
HWBI-6 Series	2137 mm	2146 mm	565 mm	575 mm

DROP-IN MODULAR/GANGED 4/3-SIZE HEATED WELLS COUNTERTOP CUTOUTS

Model	Minimum Width	Maximum Width	Minimum Depth	Maximum Depth
HWBI43-1 Series	361 mm	367 mm	740 mm	746 mm
HWBI43-2 Series	716 mm	721 mm	740 mm	746 mm
HWBI43-3 Series	1072 mm	1077 mm	740 mm	746 mm
HWBI43-4 Series	1428 mm	1432 mm	740 mm	746 mm
HWBI43-5 Series	1783 mm	1788 mm	740 mm	746 mm
HWBI43-6 Series	2139 mm	2143 mm	740 mm	746 mm

Modular/Ganged Heated Wells

Hatco Modular/Ganged Heated Wells are full-size units that are grouped together in a modular fashion to provide customers with a complete steam table contained within one piece of equipment for a clean, integrated look. Select the configuration that's right for your foodservice operation.

- Full-size, insulated Wells available in 1- to 6-Modular/Ganged units
- Individual thermostatic controls for each well provide the ultimate in temperature regulation
- 1829 mm conduit is standard for convenient placement of controls
- Wells empty quickly and easily with a manifold drain option
- Auto-fill option to automatically fill and replenish water without user maintenance and intervention
- Separate well assemblies with independent access to each one for easy service

DROP-IN MODULAR/GANGED SIZE RECTANGULAR MODELS – INSULATED – TOP MOUNT

Model	Voltage	Dimensions W x D x H	Watts	Ship Weight†	List Price
HWBI-1	220	394 x 600 x 243 mm	1215	16 kg	₹ 71639
HWBI-1D	220	394 x 600 x 243 mm	1215	18 kg	77177
HWBI-1DA	220	394 x 600 x 243 mm	1215	18 kg	109056
HWBI-2	220	749 x 600 x 243 mm	2415	34 kg	155845
HWBI-2D	220	749 x 600 x 243 mm	2415	35 kg	163939
HWBI-2DA*	220	749 x 600 x 243 mm	2415	40 kg	195889
HWBI-2M	220	749 x 600 x 243 mm	2415	34 kg	167631
HWBI-2MA	220	749 x 600 x 243 mm	2415	39 kg	210302
HWBI-3	220	1105 x 600 x 243 mm	3615	47 kg	194469
HWBI-3D	220	1105 x 600 x 243 mm	3615	52 kg	209024
HWBI-3DA*	220	1105 x 600 x 243 mm	3615	52 kg	240903
HWBI-3M	220	1105 x 600 x 243 mm	3615	49 kg	222159
HWBI-3MA	220	1105 x 600 x 243 mm	3615	51 kg	264901
HWBI-4	220	1461 x 600 x 243 mm	4815	60 kg	252121
HWBI-4D	220	1461 x 600 x 243 mm	4815	62 kg	278391
HWBI-4DA*	220	1461 x 600 x 243 mm	4815	61 kg	310270
HWBI-4M	220	1461 x 600 x 243 mm	4815	63 kg	300472
HWBI-4MA	220	1461 x 600 x 243 mm	4815	63 kg	343214
HWBI-5	220	1816 x 600 x 243 mm	6015	76 kg	302318
HWBI-5D	220	1816 x 600 x 243 mm	6015	76 kg	346551
HWBI-5DA*	220	1816 x 600 x 243 mm	6015	76 kg	379282
HWBI-5M	220	1816 x 600 x 243 mm	6015	76 kg	375590
HWBI-5MA	220	1816 x 600 x 243 mm	6015	84 kg	417125
HWBI-6	220	2172 x 600 x 243 mm	7215	86 kg	391707
HWBI-6D	220	2172 x 600 x 243 mm	7215	86 kg	427207
HWBI-6DA*	220	2172 x 600 x 243 mm	7215	88 kg	457666
HWBI-6M	220	2172 x 600 x 243 mm	7215	86 kg	466896
HWBI-6MA	220	2172 x 600 x 243 mm	7215	89 kg	507437

† Shipping weights are approximate.

* Auto-fill located on left control only and fills left-hand well. To fill all wells, drains must be connected with external manifold by installer.

All Drop-In Modular/Ganged Rectangular Heated Well Models Feature:

Voltage: Single phase.

Models Shipped with: EZ locking hardware for installation and remote thermostats with flexible conduits and lighted power switches.

OPTIONS (available at time of purchase only)

HWBI-SIDE	Copper Manifold Drain with side exit (not available on HWBI-1)	No Charge
HWB-BOTTOM	Copper Manifold Drain with bottom exit (not available on HWBI-1)	No Charge
OS-BEZEL	686 mm depth Bezel for Modular unit to match Hatco CWBX in a countertop display	No Charge
COND-3	914 mm Flexible Conduit (1829 mm standard) available on split control only	No Charge

COUNTERTOP CUTOUT DIMENSIONS – PAGE 19 ACCESSORIES – PAGES 36-37

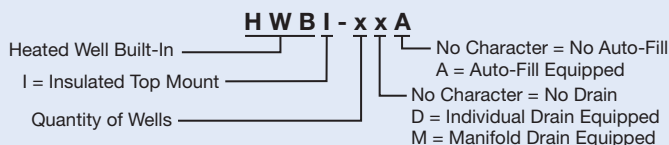

Modular/Ganged Heated Wells Controls*

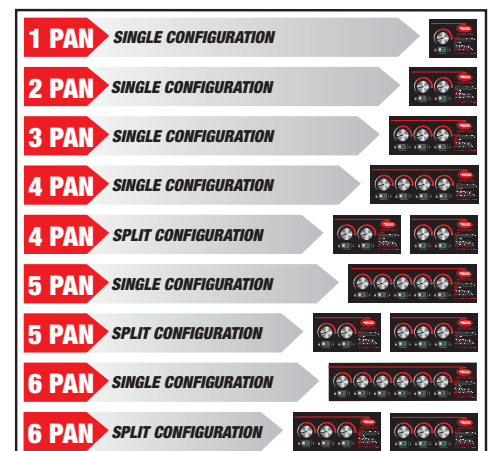

* 4-, 5-, 6-Pan Units: Single control boxes are standard. If optional split control boxes are desired, it must be specified at order.

Drop-In Modular/ Ganged 4/3-Size Heated Wells

Hatco Modular/Ganged 4/3-Size Heated Wells maintain hot food at safe serving temperatures, with better quality construction, longer holding times and more accurate temperatures. A deeper single unit can hold the equivalent of 4 third-size pans. They are also grouped together in a ganged fashion to provide customers with a complete steam table contained within one piece of

equipment. This means easy installation with a clean integrated look for your steam table.

Choose the number of wells, from 1 to 6 unit configurations, as well as voltage, auto-fill, controls and drain options. Each well has its own individual control to regulate the temperature of each food offering.

- Longer holding times with more accurate temperatures
- Separate lighted On/Off rocker switch and temperature dial for easy operation

- 50% larger drain with flat screen simplifies cleaning and holds pans level
- Unique design allows quick change of element or thermostat if needed
- EZ locking hardware for quick installation
- Stainless steel construction and solid brazed drain fitting joints for durability
- A 1829 mm conduit is included for convenient placement of controls

DROP-IN MODULAR/GANGED 4/3-SIZE RECTANGULAR MODELS – INSULATED – TOP MOUNT

Model	Dimensions W x D x H	Voltage	Watts	Ship Weight†	List Price
HWBI43-1	394 x 772 x 244 mm	220	1215	19 kg	₹103944
HWBI43-1D	394 x 772 x 244 mm	220	1215	19 kg	106997
HWBI43-1DA	394 x 772 x 244 mm	220	1215	22 kg	145408
HWBI43-2	749 x 772 x 244 mm	220	2415	40 kg	173382
HWBI43-2D	749 x 772 x 244 mm	220	2415	44 kg	179772
HWBI43-2DA*	749 x 772 x 244 mm	220	2415	44 kg	219674
HWBI43-2M	749 x 772 x 244 mm	220	2415	40 kg	197096
HWBI43-2MA	749 x 772 x 244 mm	220	2415	45 kg	237069
HWBI43-3	1105 x 772 x 244 mm	220	3615	52 kg	236643
HWBI43-3D	1105 x 772 x 244 mm	220	3615	51 kg	246086
HWBI43-3DA*	1105 x 772 x 244 mm	220	3615	56 kg	284852
HWBI43-3M	1105 x 772 x 244 mm	220	3615	54 kg	266037
HWBI43-3MA	1105 x 772 x 244 mm	220	3615	62 kg	304945
HWBI43-4	1461 x 772 x 244 mm	220	4815	67 kg	311832
HWBI43-4D	1461 x 772 x 244 mm	220	4815	69 kg	324257
HWBI43-4DA*	1461 x 772 x 244 mm	220	4815	68 kg	363094
HWBI43-4M	1461 x 772 x 244 mm	220	4815	70 kg	346835
HWBI43-4MA	1461 x 772 x 244 mm	220	4815	70 kg	385672
HWBI43-5	1816 x 772 x 244 mm	220	6015	85 kg	379921
HWBI43-5D	1816 x 772 x 244 mm	220	6015	84 kg	396038
HWBI43-5DA*	1816 x 772 x 244 mm	220	6015	85 kg	436011
HWBI43-5M	1816 x 772 x 244 mm	220	6015	84 kg	421811
HWBI43-5MA	1816 x 772 x 244 mm	220	6015	93 kg	461713
HWBI43-6	2172 x 772 x 244 mm	220	7215	97 kg	454045
HWBI43-6D	2172 x 772 x 244 mm	220	7215	97 kg	474351
HWBI43-6DA*	2172 x 772 x 244 mm	220	7215	98 kg	516170
HWBI43-6M	2172 x 772 x 244 mm	220	7215	97 kg	507863
HWBI43-6MA	2172 x 772 x 244 mm	220	7215	113 kg	549327

† Shipping weights are approximate.

* Auto-fill located on left control only and fills left-hand well. To fill all wells, drains must be connected with external manifold by installer.

All Drop-In Modular/Ganged 4/3-Size Rectangular Heated Well Models Feature:

Voltage: Single phase.

Models Shipped with: EZ locking hardware for installation and remote thermostats with flexible conduits and lighted power switches.

OPTIONS (available at time of purchase only)

HWBI-SIDE	Copper Manifold Drain with side exit (not available on HWBI43-1)	No Charge
HWBI-BOTTOM	Copper Manifold Drain with bottom exit (not available on HWBI43-1)	No Charge
	914 mm Flexible Conduit (1829 mm standard)	
COND-3	available on split control only	No Charge

HWBI43 - x x A

Heated Well Built-In	_____	No Character = No Auto-Fill
I = Insulated Top Mount	_____	A = Auto-Fill Equipped
No Character=Standard Well, Full-Size Pan	_____	No Character = No Drain
43=Extended Well, 4 Third-Size Pans	_____	D = Individual Drain Equipped
Quantity of Wells	_____	M = Manifold Drain Equipped

HWBI43-3DA with
- 4 third-size pans,
- 2 half-size pans and one third-size pan
- 1 full-size pan and 1 third-size pan



Modular/Ganged Heated Wells Controls*

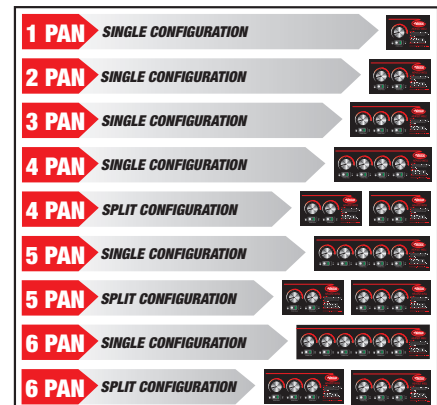

*4-, 5-, 6-pan units: Single control box is standard. If optional split control boxes are desired, it must be specified at order.

COUNTERTOP CUTOUT DIMENSIONS – PAGE 19
ACCESSORIES – PAGES 36-37

Modular/Ganged Slim Heated Wells Ordering Instructions

Wells

Cutaway of **HWBI-S4MA** with accessory food pans and optional split control boxes

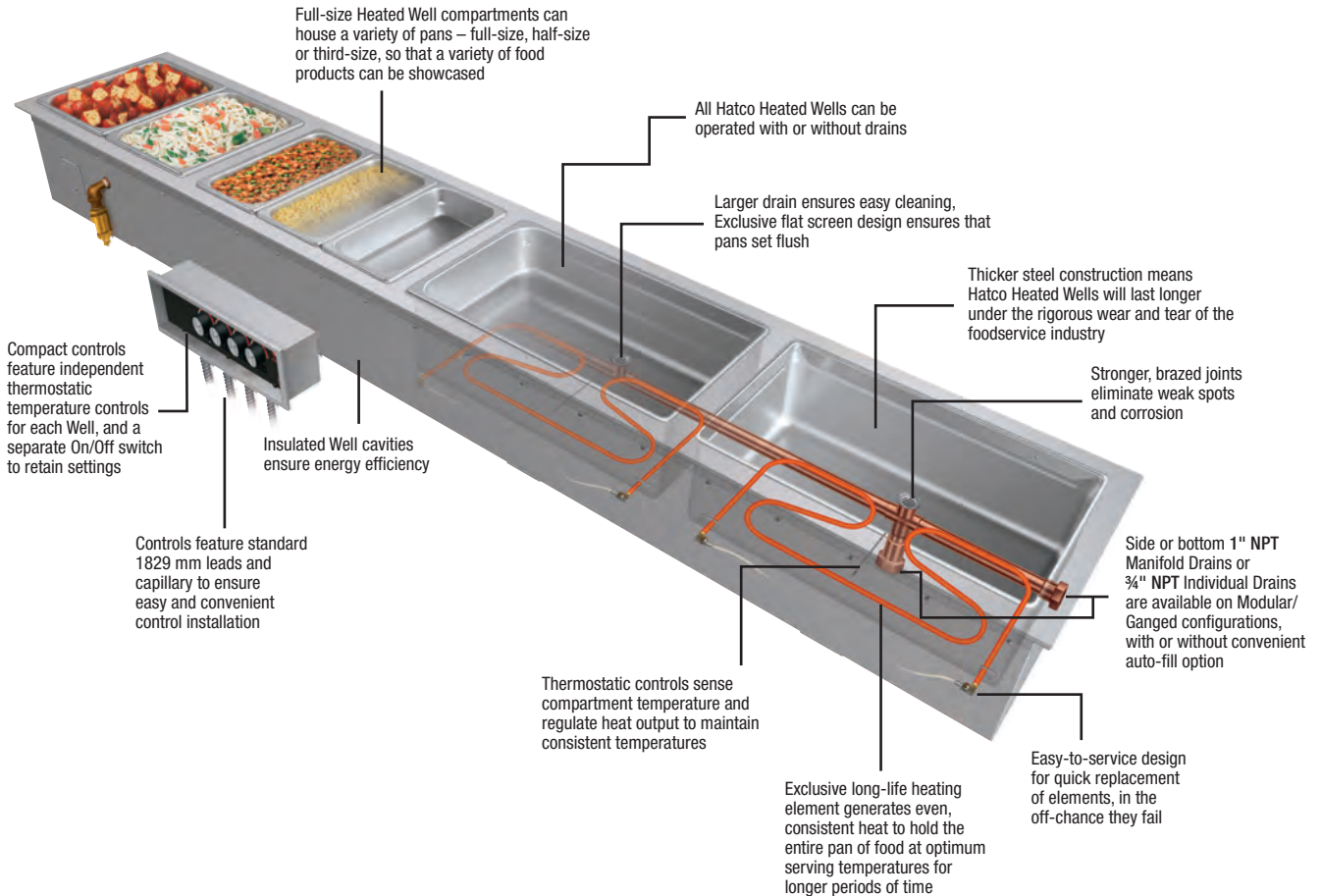

Please specify the following with each order:

1. **Desired Voltage:** 220V
2. **Number of Slim Modular/Ganged Heated Wells**
Required: 2-, 3-, 4-Pan
NOTE: Slim Modular/Ganged units are only offered as rectangular, full-size (305 x 508 mm), but placed lengthwise
3. **Drain** (with or without – choose drain below):
 A. Standard Individual Well 3/4" NPT Drain
 B. Manifold 1" NPT Drain with side drain, field selectable left or right side
 C. Manifold 1" NPT Drain with bottom drain, field selectable left or right well
4. **Auto-fill** (with or without)
5. **Bezel** allows a 481 mm depth for modular units to match Hatco Refrigerated Slim Drop-In models in a countertop display
6. **Control:**
 A. Single Control Box (standard on all units)
 B. Split Control Boxes (optional on 4-pan units and specified at order)

Accessories for Slim Modular/Ganged Heated Wells

1. **Pan Support Bars:** 305 mm or 508 mm
2. **Adapters** to convert Slim Modular/Ganged units to hold 4- or 7-liter round pans
3. **Stainless Steel Pans:**
 A. Third-size at 64 mm high (324 W x 175 D x 64 H mm)
 B. Half-size at 64 mm high (324 W x 264 D x 64 H mm)
 C. Full-size at 64 mm high (324 W x 527 D x 64 H mm)
 D. Full-size at 102 mm high (324 W x 527 D x 102 H mm)
 E. Full-size at 152 mm high (324 W x 527 D x 152 H mm)
4. **Valves:**
 1" or 3/4" NPT Ball Valve
 1" or 3/4" NPT Gate Valve

ACCESSORIES – PAGES 36-37

DROP-IN MODULAR/GANGED SLIM HEATED WELLS COUNTERTOP CUTOUTS

Model	Minimum Width	Maximum Width	Minimum Depth	Maximum Depth
HWBI-S2	1121 mm	1127 mm	362 mm	368 mm
HWBI-S3	1680 mm	1686 mm	362 mm	368 mm
HWBI-S4	2238 mm	2245 mm	362 mm	368 mm

Modular/Ganged Slim Heated Wells

Hatco Modular/Ganged Slim Heated Wells are full-sized units that are grouped together in a modular fashion but placed lengthwise. This provides customers with a complete steam table within easy reach, regardless of the sneeze guards. Select the configuration that's right for your foodservice operation.

- Full-size, insulated Wells available in 2- to 4-Modular/Ganged units
- Individual thermostatic controls for each Well provide the ultimate in temperature regulation
- 1829 mm conduit is standard for convenient placement of controls
- Wells empty quickly and easily with a manifold drain option
- Auto-fill option to automatically fill and replenish water without user maintenance and intervention
- Separate Well assemblies with independent access to each one for easy service

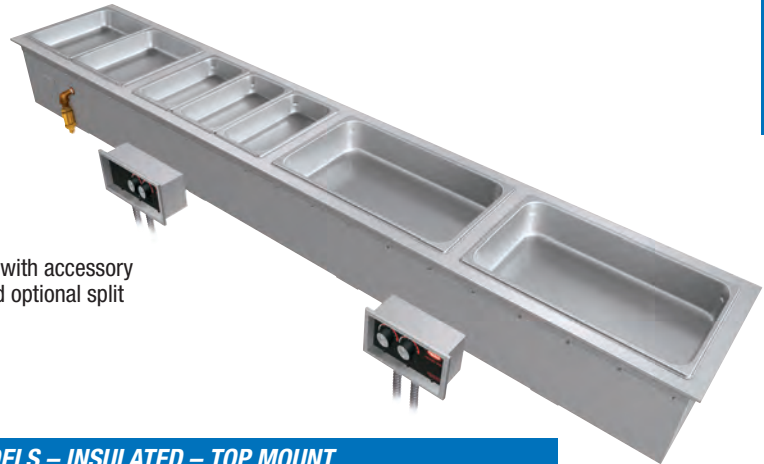

HWBI-S4MA with accessory food pans and optional split control boxes

Wells

DROP-IN MODULAR/GANGED SLIM RECTANGULAR MODELS – INSULATED – TOP MOUNT

Model	Voltage Single Phase	Dimensions W x D x H	Watts	Ship Weight†	List Price
HWBI-S2	220	1156 x 397 x 238 mm	2415	38 kg	₹168696
HWBI-S2D	220	1156 x 397 x 238 mm	2415	37 kg	176293
HWBI-S2DA*	220	1156 x 397 x 238 mm	2415	38 kg	208314
HWBI-S2M	220	1156 x 397 x 238 mm	2415	39 kg	182683
HWBI-S2MA	220	1156 x 397 x 238 mm	2415	41 kg	225212
HWBI-S3	220	1715 x 397 x 238 mm	3615	54 kg	212929
HWBI-S3D	220	1715 x 397 x 238 mm	3615	53 kg	228407
HWBI-S3DA*	220	1715 x 397 x 238 mm	3615	57 kg	259647
HWBI-S3M	220	1715 x 397 x 238 mm	3615	57 kg	242820
HWBI-S3MA	220	1715 x 397 x 238 mm	3615	57 kg	285420
HWBI-S4	220	2273 x 397 x 238 mm	4815	70 kg	282012
HWBI-S4D	220	2273 x 397 x 238 mm	4815	71 kg	305797
HWBI-S4DA*	220	2273 x 397 x 238 mm	4815	73 kg	336824
HWBI-S4M	220	2273 x 397 x 238 mm	4815	70 kg	328872
HWBI-S4MA	220	2273 x 397 x 238 mm	4815	70 kg	370407

† Shipping weights are approximate.

* Auto-fill located on left control only and fills left-hand well. To fill all wells, drains must be connected with external manifold by installer.

All Drop-In Modular/Ganged Slim Rectangular Heated Well Models Feature:

Voltage: Single phase.

Models Shipped with: EZ locking hardware for installation and remote thermostats with lighted power switches.

OPTIONS (available at time of purchase only)

HWBI-SIDE	Copper Manifold Drain with side exit	No Charge
HWBI-BOTTOM	Copper Manifold Drain with bottom exit	No Charge
OS-BEZEL	481 mm depth Bezel for Modular unit to match Hatco CWB Slim models in a countertop display	No Charge

COUNTERTOP CUTOUT DIMENSIONS – PAGE 22 ACCESSORIES – PAGES 36-37

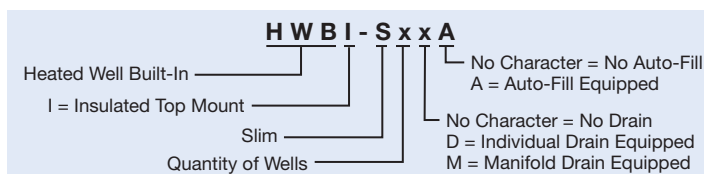

Modular/Ganged SLIM Heated Wells Controls*

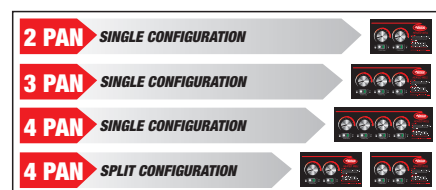

*4-Pan Units: Single control box is standard. If optional split control boxes are desired, it must be specified at order.

Individual Built-In and Drop-In Heated Wells Ordering Instructions

Wells

Please specify the following with each order:

1. **Desired Voltage:** 220V
2. **Base Size of Heated Well:**
 - A. Rectangular: Full (305 x 508 mm) or 4/3 (305 x 686 mm)
 - B. Round: 4-liter, 7-liter or 10-liter
3. **Drain** (with or without)
4. **Auto-fill** (with or without)
5. **Insulated or Uninsulated**



Insulated Well Construction
Full-size models are available with insulation for energy savings

6. **Corners**
 - A. Standard (Rounded)
 - B. Square Corners
7. **Mounting Style:**
 - A. Top Mounted
 - B. Bottom Mounted (rectangular full-size units only)
8. **Wattage:**
 - A. High watt
 - B. Standard watt

NOTE: 4-Liter Round Heated Wells are only available in standard watt configurations



Top Mounted Heated Well: Unit is mounted through the top surface of a sheet metal counter and secured with turn tabs (unit and food pan edge visible)



Bottom Mounted Heated Well: Full-size (only) unit is mounted to the bottom surface of a sheet metal counter and secured with customer provided turned bends and fasteners (food pan edge visible)

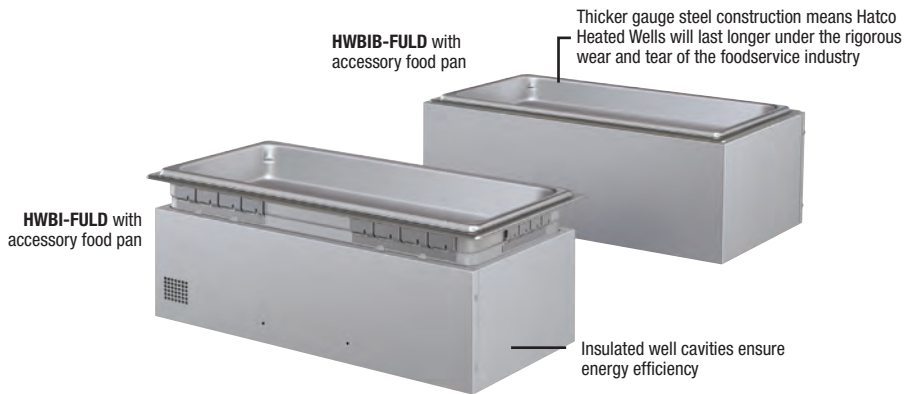

HWBIB-FULD with accessory food pan

Thicker gauge steel construction means Hatco Heated Wells will last longer under the rigorous wear and tear of the foodservice industry

HWBI-FULD with accessory food pan

Insulated well cavities ensure energy efficiency



HWB-FULD with accessory food pan (single unit holding 3 third-size pans unit depth is 553 mm)

HWB-43D with accessory food pans (single unit holding 4 third-size pans – unit depth is 726 mm)



Easy to access the heating elements, if it ever becomes necessary to change them

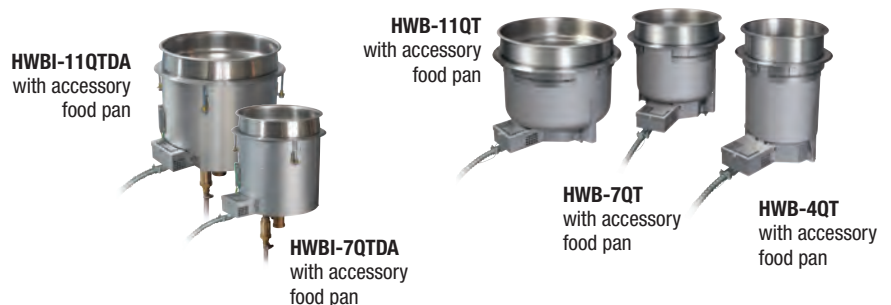

HWBI-11QTDA with accessory food pan

HWB-11QT with accessory food pan

HWBI-7QTDA with accessory food pan

HWB-7QT with accessory food pan

HWB-4QT with accessory food pan

CONTROL BOXES, COUNTERTOP CUT-OUT DIMENSIONS – PAGE 25

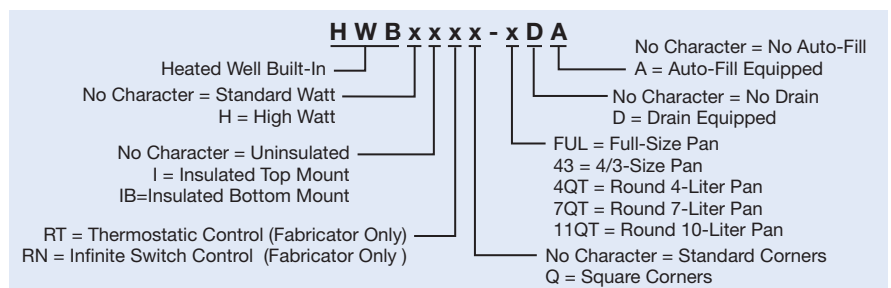

Individual Built-In And Drop-In Heated Wells Ordering Instructions

Options for Individual Built-In and Drop-In Heated Wells

1. Control Box:

- A. Larger (front mounted) Recessed Thermostatic Control Box with Lighted On/Off Rocker Switch and Angled Recessed Controls for easy readability (not for auto-fill)
- B. Optional ITC Control (not available for auto-fill, 4-liter Round Wells, Insulated Round Wells or units without a drain)
- C. Standard Control for auto-fill models only

2. Control Type:

- A. Thermostatic
 - A. Infinite
- NOTE:** Infinite controls are only available on fabricator units

3. Leads: Extended high temp lead wire, per 305 mm

4. Thermostat with 1829 mm Capillary (914 mm standard)

Accessories for Individual Built-In and Drop-In Heated Wells

1. **Mounting Kits** for combustible countertops (individual drop-in top mount units only)
2. **Pan Support Bars:** 305 or 508 mm
3. **Adapters** to convert rectangular full-size units to hold 4- or 7-liter round pans, or 4/3-size units to hold 10-liter round pans
4. **Stainless Steel Pans:**
 - A. Third-size at 64 mm deep (324 W x 175 D x 64 H mm)
 - B. Half-size at 64 mm deep (324 W x 264 D x 64 H mm)
 - C. Full-size at 64 mm deep (324 W x 527 D x 64 H mm)
 - D. Full-size at 102 mm deep (324 W x 527 D x 102 H mm)
 - E. Full-size at 152 mm deep (324 W x 527 D x 152 H mm)

STANDARD CONTROLS

Larger Recessed Thermostatic Control – No Charge



OPTIONAL CONTROLS

ITC Control (Not available for 4-liter Round Wells, Insulated Round Wells, units without a drain or auto-fill)



CONTROL TYPE – Fabricator Components



Thermostatic control



Infinite control

STANDARD CONTROL AUTO-FILL

HWB-43DA, HWBIB-, HWBI-FULDA, HWBI-7QTDA, -11QTDA Standard Control (only for auto-fill)



CONTROL CUTOUT DIMENSIONS

Standard Larger

Recessed Thermostatic Control:

149 W x 162 H mm

Optional ITC Control:

149 W x 162 H mm

HWB-43DA, HWBIB-, HWBI-FULDA Standard Control for Auto-fill

257 W x 121 H mm

5. Valve:

- A. ¼" NPT Ball Valve for unit with Drain
- B. ¾" NPT Gate Valve for unit with Drain

6. Remote Handle for ¾" Drains only and includes a Ball Valve

ACCESSORIES – PAGES 36-37



How to Order a Hatco Heated Well in Video

Hatco has given you a variety of simple and easy ways to order your well. You can read the Ordering Instructions here or watch a video "How to Order a Hatco Heated Well." Go to hatcocorp.com and click on the Video Library. While you are here, watch the "Hatco Refrigerated Wells" video as well.

COMBUSTIBLE COUNTERTOP CUTOUTS – BUILT-IN AND DROP-IN HEATED WELLS

Model	Minimum Width	Maximum Width	Minimum Depth	Maximum Depth
HWB-FUL, -FULD, FULDA, HWBQ-FUL, FULD, FULDA	356 mm	362 mm	559 mm	565 mm
HWBI-FUL, -FULD, FULDA, HWBIQ-FUL, -FULD, FULDA	356 mm	362 mm	559 mm	565 mm
HWB-, HWBI-43	356 mm	362 mm	737 mm	742 mm
HWB-, HWBI-4QT	229 mm	235 mm	229 mm	235 mm
HWB-, HWBI-7QT	279 mm	286 mm	279 mm	286 mm
HWB-, HWBI-11QT	330 mm	337 mm	330 mm	337 mm

NONCOMBUSTIBLE COUNTERTOP CUTOUTS – BUILT-IN AND DROP-IN HEATED WELLS

Model	Minimum Width	Maximum Width	Minimum Depth	Maximum Depth
HWB-, HWBQ-FUL	321 mm	328 mm	524 mm	531 mm
HWB-, HWBQ-FULDA	321 mm	328 mm	524 mm	531 mm
HWBI-FUL, -FULD, HWBIQ-FUL, -FULD	324 mm	328 mm	528 mm	531 mm
HWBI-, HWBIQ-FULDA [▼]	324 mm	328 mm	530 mm	532 mm
HWBIB-, HWBIBQ-FUL [▼] , -FULDA [▼]	306 mm	306 mm	509 mm	509 mm
HWB-, HWBI-43	323 mm	328 mm	704 mm	711 mm
HWB-4QT,	181 mm Dia.	192 mm Dia.	—	—
HWB-7QT	232 mm Dia.	242 mm Dia.	—	—
HWB-11QT	283 mm Dia.	293 mm Dia.	—	—
HWBI-4QT,	188 mm Dia.	192 mm Dia.	—	—
HWBI-7QT	239 mm Dia.	242 mm Dia.	—	—
HWBI-11QT	289 mm Dia.	293 mm Dia.	—	—

[▼] Must be flanged.

Built-In Full-Size Heated Wells

Hatco Built-In Heated Wells hold heated foods at safe-serving temperatures. Compared to other models, Hatco units offer larger drain with a flat drain screen, more consistent holding temperatures, heavier stainless steel construction, easier-to-service design for quick change of components and a remote thermostat with separate power switch.

- Rectangular full-size only in top or bottom mount, insulated or uninsulated
- Standard or high watt
- Available with or without a drain (easy to clean with a larger drain and a flat screen)
- Easy access design allows for quick element or thermostat change
- Accessory mounting kits for combustible countertops available
- Accessory adapters to convert full-size wells to hold round pans available

Control Options

– See page 25

HWB-FULD with accessory food pan



HWBIB-FULD with accessory food pan



HWBI-FULD with accessory food pan

BUILT-IN FULL-SIZE RECTANGULAR MODELS

Model	Description	Dimensions W x D x H	Voltage	Watts	Ship Weight†	List Price
Standard Watt						
HWB-FUL	Uninsulated Top or Bottom Mount	347 x 553 x 237 mm	220	1200	10 kg	₹47783
HWB-FULD	Uninsulated Top or Bottom Mount w/Drain	347 x 553 x 237 mm	220	1200	10 kg	50552
HWB-FULDA	Uninsulated Top or Bottom Mount w/Drain, Auto-fill	347 x 553 x 239 mm	220	1215	14 kg	91803
HWBI-FUL	Insulated Top or Bottom Mount	347 x 553 x 261 mm	220	1200	12 kg	54528
HWBI-FULD	Insulated Top or Bottom Mount w/Drain	347 x 553 x 261 mm	220	1200	12 kg	57297
HWBI-FULDA	Insulated Top Mount Only w/Drain, Auto-fill	347 x 553 x 263 mm	220	1215	14 kg	98548
HWBIB-FUL	Insulated Bottom Mount Only	352 x 561 x 261 mm	220	1200	13 kg	54528
HWBIB-FULD	Insulated Bottom Mount Only w/Drain	352 x 561 x 261 mm	220	1200	13 kg	57297
HWBIB-FULDA	Insulated Bottom Mount Only w/Drain, Auto-fill	352 x 561 x 261 mm	220	1215	16 kg	98548
High Watt						
HWBH-FUL	Uninsulated Top or Bottom Mount	347 x 553 x 237 mm	220	1650	10 kg	₹47783
HWBH-FULD	Uninsulated Top or Bottom Mount w/Drain	347 x 553 x 237 mm	220	1650	10 kg	50552
HWBH-FULDA	Uninsulated Top or Bottom Mount w/Drain, Auto-fill	347 x 553 x 239 mm	220	1665	12 kg	91803
HWBHI-FUL	Insulated Top or Bottom Mount	347 x 553 x 261 mm	220	1650	12 kg	54528
HWBHI-FULD	Insulated Top or Bottom Mount w/Drain	347 x 553 x 261 mm	220	1650	14 kg	57297
HWBHI-FULDA	Insulated Top Mount Only w/Drain, Auto-fill	347 x 553 x 263 mm	220	1665	14 kg	98548
HWBHIB-FUL	Insulated Bottom Mount Only	352 x 561 x 261 mm	220	1650	14 kg	54528
HWBHIB-FULD	Insulated Bottom Mount Only w/Drain	352 x 561 x 261 mm	220	1650	14 kg	57297
HWBHIB-FULDA	Insulated Bottom Mount Only w/Drain, Auto-fill	352 x 561 x 261 mm	220	1665	16 kg	98548

† Shipping weights are approximate.

All Built-In Full-Size Rectangular Heated Well Models Feature:

Voltage: Single phase.

Models Shipped with: EZ locking hardware for installation (top mounted only), 914 mm conduit and a remote thermostat with lighted power switch.

COUNTERTOP CUTOUT DIMENSIONS – PAGE 25 OPTIONS – PAGE 28 ACCESSORIES – PAGES 36-37

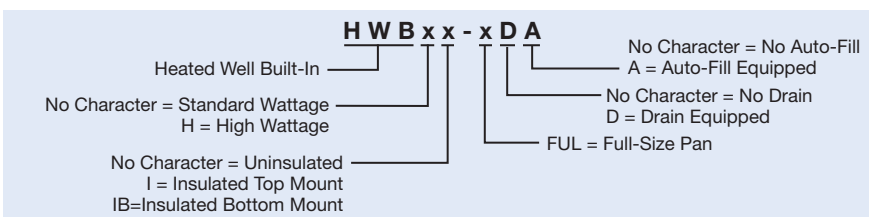

Built-In Full-Size Heated Wells with Square Corners

Control Options

– See page 25

Square Corner

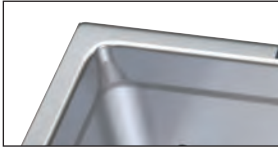

Standard Corner

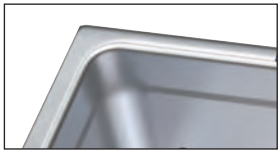

Insulated Well Construction
Full-size models are available with insulation for energy savings



Optional auto-fill supply line



All Hatco Heated Wells can be ordered with or without drains (50% larger drain with exclusive flat screen ensures the pans set flush)

Wells

BUILT-IN FULL-SIZE RECTANGULAR MODELS WITH SQUARE CORNERS

Model	Description	Dimensions W x D x H	Voltage	Watts	Ship Weight†	List Price
Standard Watt						
HWBQ-FUL	Uninsulated Top or Bottom Mount	347 x 553 x 237 mm	220	1200	10 kg	₹ 53108
HWBQ-FULD	Uninsulated Top or Bottom Mount w/Drain	347 x 553 x 237 mm	220	1200	10 kg	55877
HWBQ-FULDA	Uninsulated Top or Bottom Mount w/Drain, Auto-fill	347 x 553 x 239 mm	220	1215	14 kg	97128
HWBIQ-FUL	Insulated Top or Bottom Mount	347 x 553 x 261 mm	220	1200	12 kg	59853
HWBIQ-FULD	Insulated Top or Bottom Mount w/Drain	347 x 553 x 261 mm	220	1200	12 kg	62622
HWBIQ-FULDA	Insulated Top Mount Only w/Drain, Auto-fill	347 x 553 x 263 mm	220	1215	14 kg	103873
HWBIBQ-FUL	Insulated Bottom Mount Only	352 x 561 x 261 mm	220	1200	13 kg	59853
HWBIBQ-FULD	Insulated Bottom Mount Only w/Drain	352 x 561 x 261 mm	220	1200	13 kg	62622
HWBIBQ-FULDA	Insulated Bottom Mount Only w/Drain, Auto-fill	352 x 561 x 261 mm	220	1215	16 kg	103873
High Watt						
HWBHQ-FUL	Uninsulated Top or Bottom Mount	347 x 553 x 237 mm	220	1650	10 kg	₹ 53108
HWBHQ-FULD	Uninsulated Top or Bottom Mount w/Drain	347 x 553 x 237 mm	220	1650	10 kg	55877
HWBHQ-FULDA	Uninsulated Top or Bottom Mount w/Drain, Auto-fill	347 x 553 x 239 mm	220	1665	12 kg	97128
HWBHIQ-FUL	Insulated Top or Bottom Mount	347 x 553 x 261 mm	220	1650	12 kg	59853
HWBHIQ-FULD	Insulated Top or Bottom Mount w/Drain	347 x 553 x 261 mm	220	1650	14 kg	62622
HWBHIQ-FULDA	Insulated Top Mount Only w/Drain, Auto-fill	347 x 553 x 263 mm	220	1665	14 kg	103873
HWBHIBQ-FUL	Insulated Bottom Mount Only	352 x 561 x 261 mm	220	1650	14 kg	59853
HWBHIBQ-FULD	Insulated Bottom Mount Only w/Drain	352 x 561 x 261 mm	220	1650	14 kg	62622
HWBHIBQ-FULDA	Insulated Bottom Mount Only w/Drain, Auto-fill	352 x 561 x 261 mm	220	1665	16 kg	103873

† Shipping weights are approximate.

All Built-In Full-Size Rectangular Heated Well Models Feature:

Voltage: Single phase.

Models Shipped with: EZ locking hardware for installation (top mounted only), 914 mm conduit and a remote thermostat with lighted power switch.

COUNTERTOP CUTOUT DIMENSIONS – PAGE 25
OPTIONS – PAGE 28
ACCESSORIES – PAGES 36-37

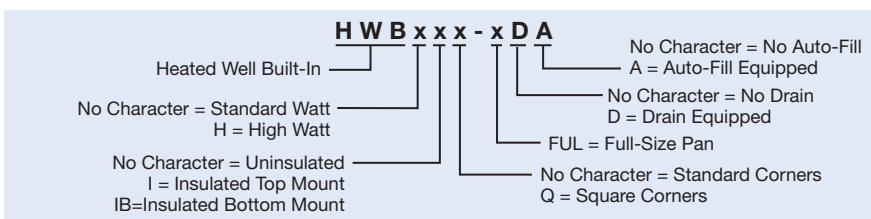

HWBL-43D and HWBLI-FULD with accessory food pans (shown with **GR2AHL** with standard *Designer* non-adjustable stands and optional *Designer* color and sneeze guards)



OPTIONS (available at time of purchase only)

Designer Colors (Flush Mount Control Box Bezel, not available for HWB-FUL w/cord) – Non-standard colors are non-returnable –

RED	Warm Red	₹2556
BLACK	Black	2556
GRAY	Gray Granite	2556
WHITE	White Granite	2556
NAVY	Navy Blue	2556
GREEN	Hunter Green	2556
COPPER	Antique Copper	2556
HWB-LEAD	Power Supply Lead Wire (Lead Wire only – Conduit not included) 1829 mm Flexible Conduit (914 mm standard) – Not available on models with HWB-, HWBI-CORD	per 305 mm ₹ 568
COND-6	HWB-FUL with Cord Standard (Shown below)	2414
HWB-CORD	All models except Auto-fill models HWBI-FUL with Cord Standard	add 1988
HWBI-CORD	Top Mount: HWBI-FUL, -FULD and HWBHI-FUL, FULD Bottom Mount: HWBIB-FULDA, and HWBHIB-FULDA	add 1988
HWBIB-BRKT	Mounting Bracket for Insulated Bottom Mount (HWBIB series)	add 1349
Control Options –		
HWB-TSTAT	Thermostat with 1829 mm Capillary (Not available for auto-fill models) Larger Recessed Thermostatic Control (not available for auto-fill models, standard on 220 or 240V export models)	4828
HWB-RTC	ITC Control (not available for auto-fill models, units without a drain or low watt configurations)	No Charge
HWB-ITC		16188

ACCESSORIES – PAGES 36-37
COLORS AND FINISHES – INSIDE BACK COVER



Optional ITC Control – Not for low watt configurations – shown with optional control box bezel in *Designer* White Granite



HWB-CORD
HWB with optional cord

Drop-In 4/3-Size Heated Wells

Convenient 4/3-Size Wells hold heated foods at safe-serving temperatures. Like the full-size models, Hatco units offer a larger drain with a flat drain screen, more consistent holding temperatures, heavier stainless steel construction, easier-to-service design for quick change of components and a remote thermostat with separate power switch.

- Rectangular 4/3-size wells
- Standard or high watt
- Available with or without a drain (easy to clean with a larger drain and a flat screen)
- Easy access design allows for quick element or thermostat change
- Accessory mounting kits for combustible countertops available
- Accessory adapters to convert 4/3-size wells to hold round pans

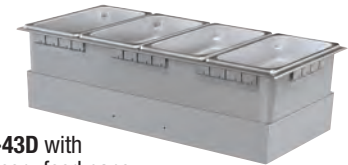

HWB-43D with accessory food pans (single unit holding 4 third-size pans)



HWBI-43D with accessory food pans (single unit holding 4 third-size pans)

Wells

DROP-IN 4/3-SIZE RECTANGULAR MODELS

Model	Description	Dimensions W x D x H	Voltage	Watts	Ship Weight†	List Price
Standard Watt						
HWB-43	Uninsulated	345 x 726 x 239 mm	220	1200	11 kg	₹53179
HWB-43D	Uninsulated w/Drain	345 x 726 x 239 mm	220	1200	11 kg	55948
HWB-43DA	Uninsulated w/Drain, Auto-fill	345 x 726 x 239 mm	220	1215	13 kg	97199
HWBI-43	Insulated	345 x 726 x 262 mm	220	1200	14 kg	59924
HWBI-43D	Insulated w/Drain	345 x 726 x 262 mm	220	1200	14 kg	62693
High Watt						
HWBH-43	Uninsulated	345 x 726 x 239 mm	220	1650	11 kg	₹53179
HWBH-43D	Uninsulated w/Drain	345 x 726 x 239 mm	220	1650	11 kg	55948
HWBH-43DA	Uninsulated w/Drain, Auto-fill	345 x 726 x 239 mm	220	1665	14 kg	97199
HWBHI-43	Insulated	345 x 726 x 262 mm	220	1650	14 kg	59924
HWBHI-43D	Insulated w/Drain	345 x 726 x 262 mm	220	1650	14 kg	62693

† Shipping weights are approximate.

All Drop-In 4/3-Size Rectangular Heated Well Models Feature:

Voltage: Single phase.

Models Shipped with: EZ locking hardware for installation, 914 mm (36") conduit and a remote thermostat with lighted power switch.

OPTIONS (available at time of purchase only)

HWB-LEAD	Power Supply Lead Wire (Lead Wire only – Conduit not included)	per 305 mm ₹ 568
COND-6	1829 mm Flexible Conduit (914 mm standard)	2414
HWB-TSTAT	Thermostat with 1829 mm Capillary	4828
HWB-RTC	Larger Recessed Thermostatic Control (not available for auto-fill, standard on 220 or 240V export models)	No Charge
HWB-ITC	ITC Control (not available for auto-fill models)	16188
HWB-AFL	Models HWB, HWBH, HWBL-43DA only - Left water fill hole (front is standard)	No Charge
HWB-AFR	Models HWB, HWBH, HWBL-43DA only - Right water fill hole (front is standard)	No Charge

Designer Colors (Control Box Bezel) – Non-standard colors are non-returnable) –

RED	Warm Red	₹2556
BLACK	Black	2556
GRAY	Gray Granite	2556
WHITE	White Granite	2556
NAVY	Navy Blue	2556
GREEN	Hunter Green	2556
COPPER	Antique Copper	2556

CONTROL OPTIONS – PAGE 25
COUNTERTOP CUT-OUT DIMENSIONS – PAGE 25
ACCESSORIES – PAGES 36-37
COLORS AND FINISHES – INSIDE BACK COVER

Insulated Well Construction
 Full-size models are available with insulation for energy savings



HWB x x - x D A

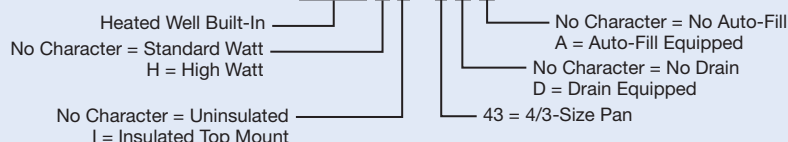

Drop-In Round Heated Uninsulated Wells

Keeping hot food at safe-serving temperatures is critical to any foodservice operation – and Hatco has the Heated Wells to meet the demands of any serving application. Thermostatic controls monitor and regulate the temperature of the well for more accurate heat and energy savings. Hatco controls feature a separate On/Off switch, which allows a previously determined setting to be maintained.

- 4-, 7- and 10-liter Round Wells
- Standard or high watt (4-liter standard watt only)
- With or without drain
- EZ locking hardware for easy top mount installation
- Accessory mounting kits for combustible countertops available

Control Options

- Larger front-mounted recessed thermostatic control box with lighted On/Off rocker switch and angled recessed controls for easy readability
- Optional ITC control with large control box available for easier reading on 7- or 10-liter (7- or 11-quart) standard or high watt configurations

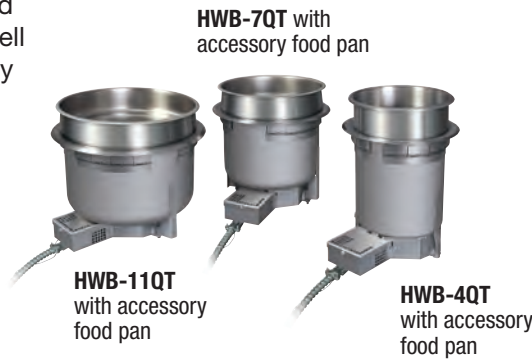

Optional ITC control – (not for 4-liter [4-quart] Round Wells or units without a drain) shown with optional control box bezel in Designer White Granite



Large recessed thermostatic control (standard)

DROP-IN ROUND MODELS – UNINSULATED

Model	Description	Dimensions Dia. x H	Voltage	Watts	Ship Weight†	List Price
4-Liter – Standard Watt						
HWB-4QT	Top Mount	212 x 270 mm	220	600	5 kg	₹45582
HWB-4QTD	Top Mount w/Drain	212 x 270 mm	220	600	5 kg	48351
7-Liter – Standard Watt						
HWB-7QT	Top Mount	262 x 244 mm	220	600	6 kg	₹45582
HWB-7QTD	Top Mount w/Drain	262 x 244 mm	220	600	6 kg	48351
7-Liter – High Watt						
HWBH-7QT	Top Mount	262 x 244 mm	220	800	6 kg	₹45582
HWBH-7QTD	Top Mount w/Drain	262 x 244 mm	220	800	6 kg	48351
10-Liter – Standard Watt						
HWB-11QT	Top Mount	313 x 244 mm	220	600	6 kg	₹45582
HWB-11QTD	Top Mount w/Drain	313 x 244 mm	220	600	6 kg	48351
10-Liter – High Watt						
HWBH-11QT	Top Mount	313 x 244 mm	220	800	6 kg	₹45582
HWBH-11QTD	Top Mount w/Drain	313 x 244 mm	220	800	6 kg	48351

† Shipping weights are approximate.

All Drop-In Round Uninsulated Heated Well Models Feature:

Voltage: Single phase.

Models Shipped with: EZ locking hardware for installation, 914 mm conduit and a remote thermostat with lighted power switch.

OPTIONS (available at time of purchase only)

HWB-LEAD	Power Supply Lead Wire (Lead Wire only – Conduit not included)	per 305 mm	₹ 568
COND-6	1829 mm Flexible Conduit (914 mm standard)		2414
HWB-TSTAT	Thermostat with 1829 mm Capillary		4828
HWB-RTC	Larger Recessed Thermostatic Control (not available for auto-fill, standard on 220 or 240V export models)		No Charge
HWB-ITC	ITC Control with large Control Box for 7- and 10-liter Drop-In Round Wells only		16188

Designer Colors (Control Box Bezel) –

Non-standard colors are non-returnable) –

RED	Warm Red	₹2556
BLACK	Black	2556
GRAY	Gray Granite	2556
WHITE	White Granite	2556
NAVY	Navy Blue	2556
GREEN	Hunter Green	2556
COPPER	Antique Copper	2556

COUNTERTOP CUTOUT DIMENSIONS – PAGE 25

ACCESSORIES – PAGES 36-37

COLORS AND FINISHES – INSIDE BACK COVER

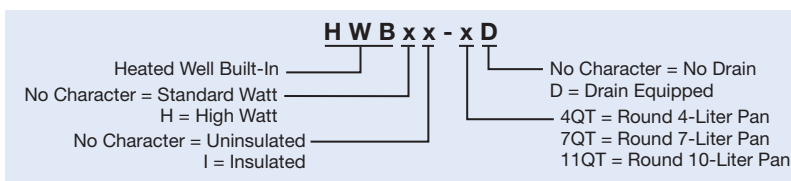

Drop-In Round Insulated Heated Wells

Hatco Drop-In Round Insulated Heated Wells provide flexibility and quality, with many options to choose from. These units hold steam table food hot and fresh with self-adjusting thermostats that monitor the actual temperatures and control the heat only when needed.

- Available in insulated 4-, 7- and 10-liter Round Wells
- Standard or high watt (4-liter standard watt only)
- Controls feature a separate lighted ON/OFF rocker switch
- Easy service access to heating elements and thermostats
- Mounting kits for combustible countertops available
- Auto-Fill models available in 7 and 10 liter round wells

Control Options

- Larger front-mounted recessed thermostatic control box with lighted On/Off rocker switch and angled recessed controls for easy readability

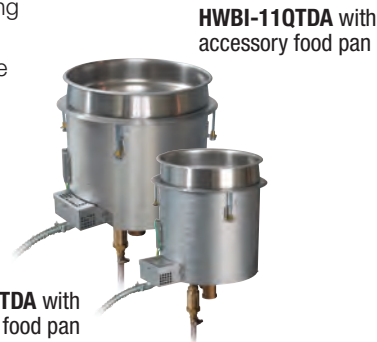

HWB-7QTDA with accessory food pan



Larger recessed thermostatic control at no charge

Wells

DROP-IN ROUND MODELS – INSULATED

Model	Description	Dimensions Dia. x H	Voltage	Watts	Ship Weight†	List Price
4-Liter – Standard Watt						
HWBI-4QT	Top Mount	212 x 271 mm	220	600	6 kg	₹52327
HWBI-4QTD	Top Mount w/Drain	212 x 271 mm	220	600	6 kg	55096
7-Liter – Standard Watt						
HWBI-7QT	Top Mount	262 x 247 mm	220	600	6 kg	₹52327
HWBI-7QTD	Top Mount w/Drain	262 x 247 mm	220	600	7 kg	55096
HWBI-7QTDA	Top Mount w/Drain, Auto-fill	262 x 247 mm	220	615	8 kg	96347
7-Liter – High Watt						
HWBHI-7QT	Top Mount	262 x 247 mm	220	800	6 kg	₹52327
HWBHI-7QTD	Top Mount w/Drain	262 x 247 mm	220	800	7 kg	55096
HWBHI-7QTDA	Top Mount w/Drain, Auto-fill	262 x 247 mm	220	815	8 kg	96347
10-Liter – Standard Watt						
HWBI-11QT	Top Mount	313 x 246 mm	220	600	8 kg	₹52327
HWBI-11QTD	Top Mount w/Drain	313 x 246 mm	220	600	8 kg	55096
HWBI-11QTDA	Top Mount w/Drain, Auto-fill	313 x 246 mm	220	615	11 kg	96347
10-Liter – High Watt						
HWBHI-11QT	Top Mount	313 x 246 mm	220	800	8 kg	₹52327
HWBHI-11QTD	Top Mount w/Drain	313 x 246 mm	220	800	8 kg	55096
HWBHI-11QTDA	Top Mount w/Drain, Auto-fill	313 x 246 mm	220	815	11 kg	96347

† Shipping weights are approximate.

All Drop-In Round Insulated Heated Well Models Feature:

Voltage: Single phase.

Models Shipped with: 914 mm conduit and a remote thermostat with lighted power switch.

OPTIONS (available at time of purchase only)

HWB-LEAD	Power Supply Lead Wire (Lead Wire only – Conduit not included)	per 305 mm ₹ 568
COND-6	1829 mm Flexible Conduit (914 mm standard)	2414
HWB-TSTAT	Thermostat with 1829 mm Capillary	4828
HWB-RTC	Larger Recessed Thermostatic Control (not available for auto-fill, standard on 220 or 240V export models)	No Charge

COUNTERTOP CUTOUT DIMENSIONS – PAGE 25 ACCESSORIES – PAGES 36-37

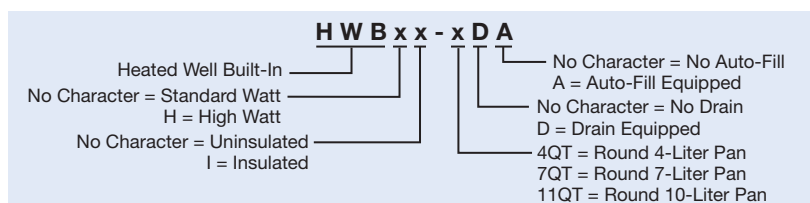

Built-In Full-Size Heated Wells - Fabricator Components

Having the same great features as all of the Hatco Heated Wells, plus the added benefit of allowing fabricators the freedom to design their own steam tables, these units hold hot food products at safe-serving temperatures.

- Without conduit and control box enclosure
- Thermostatic or infinite controls available
- With or without drains
- Full-size rectangular wells
- Standard or high watt models



HWBRT-FULD
with accessory food pan



HWBIRT-FULD with accessory food pan

HWBIBRT-FULD with accessory food pan

Standard Corner



BUILT-IN FULL-SIZE RECTANGULAR FABRICATOR COMPONENTS

Model [†]	Description	Dimensions		Voltage	Watts	Ship Weight [†]	List Price
		(Top Mount)	W x D x H				
Standard Watt							
HWBRT-FUL	Uninsulated Top or Bottom Mount		347 x 553 x 237 mm	220	1200	9 kg	₹54528
HWBRT-FULD	Uninsulated Top or Bottom Mount w/Drain		347 x 553 x 237 mm	220	1200	9 kg	57297
HWBRN-FUL	Uninsulated Top or Bottom Mount		347 x 553 x 237 mm	220	1200	9 kg	54528
HWBRN-FULD	Uninsulated Top or Bottom Mount w/Drain		347 x 553 x 237 mm	220	1200	9 kg	57297
HWBIRT-FUL	Insulated Top or Bottom Mount		347 x 553 x 261 mm	220	1200	11 kg	59853
HWBIRT-FULD	Insulated Top or Bottom Mount w/Drain		347 x 553 x 261 mm	220	1200	12 kg	62622
HWBIBRT-FUL	Insulated Bottom Mount Only		352 x 561 x 261 mm	220	1200	12 kg	59853
HWBIBRT-FULD	Insulated Bottom Mount Only w/Drain		352 x 561 x 261 mm	220	1200	12 kg	62622
High Watt							
HWBHRT-FUL	Uninsulated Top or Bottom Mount		347 x 553 x 237 mm	220	1650	9 kg	₹54528
HWBHRT-FULD	Uninsulated Top or Bottom Mount w/Drain		347 x 553 x 237 mm	220	1650	9 kg	57297
HWBHRN-FUL	Uninsulated Top or Bottom Mount		347 x 553 x 237 mm	220	1650	9 kg	54528
HWBHRN-FULD	Uninsulated Top or Bottom Mount w/Drain		347 x 553 x 237 mm	220	1650	9 kg	57297
HWBHIRT-FUL	Insulated Top or Bottom Mount		347 x 553 x 261 mm	220	1650	12 kg	59853
HWBHIRT-FULD	Insulated Top or Bottom Mount w/Drain		347 x 553 x 261 mm	220	1650	13 kg	62622
HWBHIBRT-FUL	Insulated Bottom Mount Only		352 x 561 x 261 mm	220	1650	13 kg	59853
HWBHIBRT-FULD	Insulated Bottom Mount Only w/Drain		352 x 561 x 261 mm	220	1650	13 kg	62622

[†] Shipping weights are approximate.

■ "RT" added to model name indicates unit with thermostat control, lit rocker switch and 914 mm capillary. "RN" added to model name indicates unit with infinite switch control, pilot light and 914 mm leads.

All Built-In Full-Size Rectangular Fabricator Heated Well Models Feature:

Voltage: Single phase.

Models shipped with: EZ locking hardware for installation (top mounted only).

OPTIONS (available at time of purchase only)

HWB-LEAD-UR	Power Supply Lead Wire for "RN" Components (Lead Wire only – Conduit not included)	per 305 mm ₹ 568
HWB-TSTAT-UR	Thermostat with 1829 mm Capillary for "RT" Components (Thermostat only – Conduit not included)	3337

COUNTERTOP CUTOUT DIMENSIONS – PAGE 25

CONTROL OPTIONS – PAGE 25

ACCESSORIES – PAGES 36-37

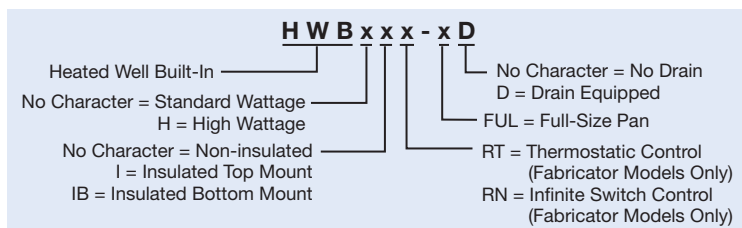

Insulated Well Construction

Full-size models are available with insulation for energy savings



Built-In Full-Size Heated Wells with Square Corners – Fabricator Components

Control Options – Fabricator Components

– See page 25

Square Corner

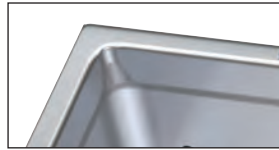

Standard Corner

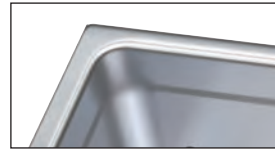

All Hatco Heated Wells can be ordered with or without drains (50% larger drain with exclusive flat screen ensures the pans set flush)

BUILT-IN FULL-SIZE RECTANGULAR FABRICATOR COMPONENTS WITH SQUARE CORNERS

Model ¹	Description	Dimensions W x D x H	Voltage	Watts	Ship Weight ¹	List Price
Standard Watt						
HWBRTQ-FUL	Uninsulated Top or Bottom Mount	347 x 553 x 237 mm	220	1200	9 kg	₹59853
HWBRTQ-FULD	Uninsulated Top or Bottom Mount w/Drain	347 x 553 x 237 mm	220	1200	9 kg	62622
HWBRNQ-FUL	Uninsulated Top or Bottom Mount	347 x 553 x 237 mm	220	1200	9 kg	59853
HWBRNQ-FULD	Uninsulated Top or Bottom Mount w/Drain	347 x 553 x 237 mm	220	1200	9 kg	62622
HWBIRTQ-FUL	Insulated Top or Bottom Mount	347 x 553 x 261 mm	220	1200	11 kg	65178
HWBIRTQ-FULD	Insulated Top or Bottom Mount w/Drain	347 x 553 x 261 mm	220	1200	12 kg	67947
HWBIBRTQ-FUL	Insulated Bottom Mount Only	352 x 561 x 261 mm	220	1200	12 kg	65178
HWBIBRTQ-FULD	Insulated Bottom Mount Only w/Drain	352 x 561 x 261 mm	220	1200	12 kg	67947
High Watt						
HWBHRTQ-FUL	Uninsulated Top or Bottom Mount	347 x 553 x 237 mm	220	1650	9 kg	₹59853
	Uninsulated Top or Bottom Mount w/Drain		220	1650	9 kg	62622
HWBHRNQ-FUL	Uninsulated Top or Bottom Mount	347 x 553 x 237 mm	220	1650	9 kg	59853
HWBHRNQ-FULD	Uninsulated Top or Bottom Mount w/Drain	347 x 553 x 237 mm	220	1650	9 kg	62622
HWBHIRTQ-FUL	Insulated Top or Bottom Mount	347 x 553 x 261 mm	220	1650	12 kg	65178
HWBHIRTQ-FULD	Insulated Top or Bottom Mount w/Drain	347 x 553 x 261 mm	220	1650	13 kg	67947
HWBHIBRTQ-FUL	Insulated Bottom Mount Only	352 x 561 x 261 mm	220	1650	13 kg	65178
HWBHIBRTQ-FULD	Insulated Bottom Mount Only w/Drain	352 x 561 x 261 mm	220	1650	13 kg	67947

¹ Shipping weights are approximate.

■ "RT" added to model name indicates unit with thermostat control, lit rocker switch and 914 mm capillary. "RN" added to model name indicates unit with infinite switch control, pilot light and 914 mm leads.

All Built-In Full-Size Rectangular Fabricator Heated Well Models Feature:

Voltage: Single phase.

Models shipped with: EZ locking hardware for installation (top mounted only).

OPTIONS (available at time of purchase only)

HWB-LEAD-UR	Power Supply Lead Wire for "RN" Components (Lead Wire only – Conduit not included)	per 305 mm ₹ 568
HWB-TSTAT-UR	Thermostat with 1829 mm Capillary for "RT" Components (Thermostat only – Conduit not included)	3337

COUNTERTOP CUTOUT DIMENSIONS – PAGE 25

CONTROL OPTIONS – PAGE 25

ACCESSORIES – PAGES 36-37

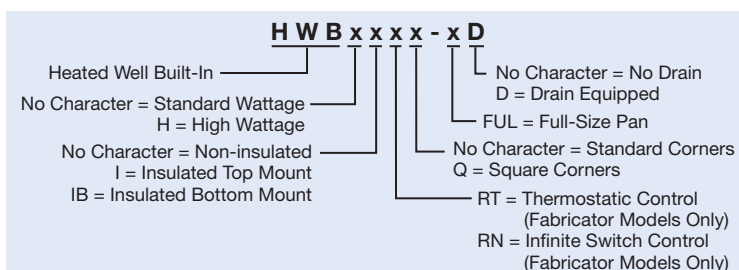

Drop-In 4/3-Size Heated Wells - Fabricator Components

Having the same great features as all of the Hatco Heated Wells, plus the added benefit of allowing fabricators the freedom to design their own steam tables, these units hold hot food products at safe-serving temperatures.

- Without conduit and control box enclosure
- Thermostatic or infinite controls available
- With or without drains
- 4/3-size rectangular wells
- Standard or high watt models



HWBRT-43D with accessory food pans (single unit holding 4 third-size pans)

Control Options

The Fabricator models can have the following control choices:

- Thermostatic controls, which feature an On/Off switch with light
- Infinite controls with indicator light



Thermostatic control



Infinite control

CONTROL CUTOUT DIMENSIONS

Control	Width	Height
Thermostatic	54 mm	86 mm
Infinite	54 mm	86 mm

DROP-IN 4/3-SIZE RECTANGULAR FABRICATOR COMPONENTS

Model #	Description	Dimensions W x D x H	Voltage	Watts	Ship Weight [†]	List Price
Standard Watt						
HWBRT-43	Uninsulated	345 x 726 x 237 mm	220	1200	11 kg	₹59924
HWBRT-43D	Uninsulated w/Drain	345 x 726 x 237 mm	220	1200	10 kg	62693
HWBRN-43	Uninsulated	345 x 726 x 237 mm	220	1200	10 kg	59924
HWBRN-43D	Uninsulated w/Drain	345 x 726 x 237 mm	220	1200	10 kg	62693
High Watt						
HWBHRT-43	Uninsulated	345 x 726 x 237 mm	220	1650	11 kg	₹59924
HWBHRT-43D	Uninsulated w/Drain	345 x 726 x 237 mm	220	1650	10 kg	62693
HWBHRN-43	Uninsulated	345 x 726 x 237 mm	220	1650	10 kg	59924
HWBHRN-43D	Uninsulated w/Drain	345 x 726 x 237 mm	220	1650	10 kg	62693

[†] Shipping weights are approximate.

■ "RT" added to model name indicates unit with thermostat control, lit rocker switch and 914 mm capillary.

"RN" added to model name indicates unit with infinite switch control, pilot light and 914 mm leads.

All Drop-In 4/3-Size Rectangular Fabricator Heated Well Models Feature:

Voltage: Single phase.

Models Shipped with: EZ locking hardware for installation.

OPTIONS (available at time of purchase only)

HWB-LEAD-UR	Power Supply Lead Wire for "RN" Components (Lead Wire only – Conduit not included)	per 305 mm ₹ 568
HWB-TSTAT-UR	Thermostat with 1829 mm Capillary for "RT" Components (Thermostat only – Conduit not included)	3337

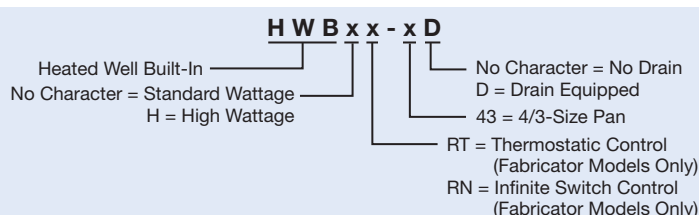

COUNTERTOP CUT-OUT DIMENSIONS – PAGE 25
ACCESSORIES – PAGES 36-37

Drop-In Round Heated Wells – Fabricator Components

Ideal for the fabricator who wants to design a specific steam table layout. Easy to install, and easy to service, the Round Heated Wells come with control, size, drain and wattage choices.

- 4-, 7- and 10-liter round wells
- Standard or high watt (4-liter standard watt only)
- With or without drain
- Thermostatic or infinite controls available
- Without conduit and control box enclosure

Control Options

– See page 34



Wells

DROP-IN ROUND FABRICATOR COMPONENTS – UNINSULATED

Model #	Description	Dimensions (Dia. x H)	Voltage	Watts	Ship Weight†	List Price
4-Liter – Standard Watt						
HWBRT-4QT	Top Mount	212 x 270 mm	220	600	4 kg	₹52327
HWBRT-4QTD	Top Mount w/Drain	212 x 270 mm	220	600	4 kg	55096
HWBRN-4QT	Top Mount	212 x 270 mm	220	600	4 kg	52327
HWBRN-4QTD	Top Mount w/Drain	212 x 270 mm	220	600	5 kg	55096
7-Liter – Standard Watt						
HWBRT-7QT	Top Mount	262 x 244 mm	220	600	5 kg	₹52327
HWBRT-7QTD	Top Mount w/Drain	262 x 244 mm	220	600	5 kg	55096
HWBRN-7QT	Top Mount	262 x 244 mm	220	600	4 kg	52327
HWBRN-7QTD	Top Mount w/Drain	262 x 244 mm	220	600	5 kg	55096
7-Liter – High Watt						
HWBHRT-7QT	Top Mount	262 x 244 mm	220	800	5 kg	₹52327
HWBHRT-7QTD	Top Mount w/Drain	262 x 244 mm	220	800	4 kg	55096
HWBHRN-7QT	Top Mount	262 x 244 mm	220	800	4 kg	52327
HWBHRN-7QTD	Top Mount w/Drain	262 x 244 mm	220	800	6 kg	55096
10-Liter – Standard Watt						
HWBRT-11QT	Top Mount	313 x 244 mm	220	600	5 kg	₹52327
HWBRT-11QTD	Top Mount w/Drain	313 x 244 mm	220	600	5 kg	55096
HWBRN-11QT	Top Mount	313 x 244 mm	220	600	5 kg	52327
HWBRN-11QTD	Top Mount w/Drain	313 x 244 mm	220	600	6 kg	55096
10-Liter – High Watt						
HWBHRT-11QT	Top Mount	313 x 244 mm	220	800	5 kg	₹52327
HWBHRT-11QTD	Top Mount w/Drain	313 x 244 mm	220	800	5 kg	55096
HWBHRN-11QT	Top Mount	313 x 244 mm	220	800	5 kg	52327
HWBHRN-11QTD	Top Mount w/Drain	313 x 244 mm	220	800	6 kg	55096

† Shipping weights are approximate.

■ "RT" added to model name indicates unit with thermostat control, lit rocker switch and 914 mm capillary. "RN" added to model name indicates unit with infinite switch control, pilot light and 914 mm leads. "D" added to model name indicates unit with drain.

All Drop-In Round Fabricator Heated Well Models Feature:

Voltage: Single phase.

Models Shipped with: EZ locking hardware for installation.

OPTIONS (available at time of purchase only), Fabricator Components Only –

HWB-LEAD-UR	Power Supply Lead Wire (Lead Wire only – Conduit not included)	per 305 mm	₹ 568
HWB-TSTAT-UR	Thermostat with 1829 mm Capillary		3337

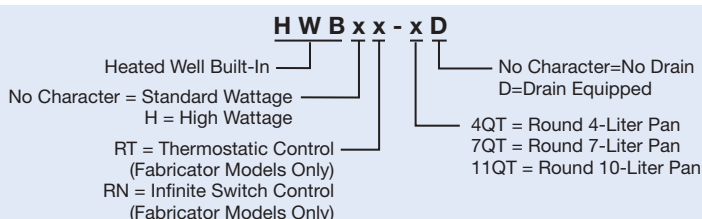

COUNTERTOP CUT-OUT DIMENSIONS – PAGE 25
ACCESSORIES – PAGES 36-37

Wells Accessories (available for purchase at any time)

Wells



FTBX-2
with accessory
full-size
sheet pans

HWBI-2
with accessory
half and third-size
food pans

ST PAN 1/3

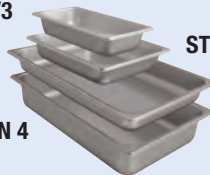

ST PAN 1/2

ST PAN 2

ST PAN 4



HDW 6" PAN

11QT-PAN



4QT-PAN

7QT-PAN

PANS – LIDS – TRIVETS

ST PAN 1/3	Third-Size Stainless Steel Pan – 324 W x 175 D x 64 H mm	₹3550
ST PAN 1/2	Half-Size Stainless Steel Pan – 324 W x 264 D x 64 H mm	3976
ST PAN 2	Full-Size Stainless Steel Pan – 324 W x 527 D x 64 H mm	4828
ST PAN 4	Full-Size Stainless Steel Pan – 324 W x 527 D x 102 H mm	6106
HDW 6 PAN	Full-Size Stainless Steel Pan – 324 W x 527 D x 152 H mm	6674
4QT-PAN	4-Liter Round Pan	6319
7QT-PAN	7-Liter Round Pan	7029
11QT-PAN	10-Liter Round Pan (not suitable for RHW, see page 39)	7739
Notched Lid for Round Pans (not suitable for RHW, see page 39) –		
4QT-LID-1	4-Liter Round, Notched, Solid Lid	₹2982
7QT-LID-1	7-Liter Round, Notched, Solid Lid	3692
11QT-LID-1	10-Liter Round, Notched, Solid Lid	4402
Hinged Lid for Round Pans (not suitable for RHW, see page 39) –		
4QT-LID	4-Liter Round, Hinged and Notched Lid	₹3905
7QT-LID	7-Liter Round, Hinged and Notched Lid	5112
11QT-LID	10-Liter Round, Hinged and Notched Lid	6319
Wire Trivets Stainless –		
TRIVET (1/2)SS	Half-Size – 259 W x 194 D mm	₹6674
TRIVET SS	Full-Size – 259 W x 457 D mm	9088



11QT-LID-1



7QT-LID-1



4QT-LID-1



11QT-LID

7QT-LID



4QT-LID

TRIVET (1/2)SS

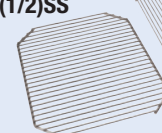

TRIVET SS

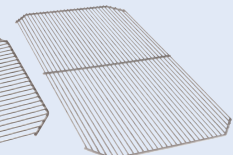

ADAPTERS, SUPPORT BARS, MOUNTING KITS, VALVES – PAGE 37

HWB-2-7Q shown with two 7QT-PAN and 7QT-LID-1

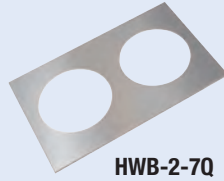

HWB-2-7Q



HWB-2-11Q

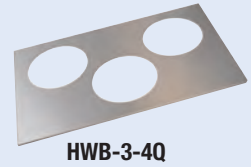

HWB-3-4Q

ADAPTERS – SUPPORT BARS

HWB-2-7Q	Adapter to convert warmer to hold two 7-Liter Inserts (models HWBI & HWB-FUL series only)	₹ 5396
HWB-3-4Q	Adapter to convert warmer to hold three 4-Liter Inserts (models HWBI & HWB-FUL series only)	5396
HWB-2-11Q	Adapter to convert warmer to hold two 10-Liter Inserts (model HWB-43 and HWBI43 series only)	6745
HWB12BAR	305 mm Pan Support Bar for Built-In and Drop-In Heated Wells	1136
HWB20BAR	508 mm Pan Support Bar for Built-In and Drop-In Heated Wells	1349
HWBGM12BAR	305 mm Pan Support Bar for Drop-In Modular/Ganged Models	1136
HWBGM20BAR	508 mm Pan Support Bar for Drop-In Modular/Ganged Models (models HWBI- and HWBI-S series only)	1349

Support Bars
Choose the appropriate kit for CWB, HWBI or HWB series

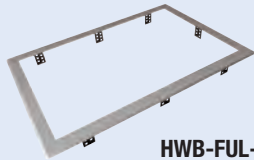

HWB-FUL-MNT
Choose the appropriate kit for HWB-FUL, HWB-43 or HWB-4Q, -7Q, -11Q series



HWB-MNT-REC or HWB-MNT-RND



HWBI2MANIF



BALLVALVE1INCH



GATEVALVE1INCH

MOUNTING KITS – VALVES

Necessary at your Well installation –

HWB-FUL-MNT	Mounting Kit for combustible countertops for HWB-FUL series only	₹ 6958
HWB-43-MNT	Mounting Kit for combustible countertops for HWB-43 series only	8307
HWB-4Q-MNT	Mounting Kit for combustible countertops for HWB-4Q series only	4118
HWB-7Q-MNT	Mounting Kit for combustible countertops for HWB-7Q series only	4544
HWB-11Q-MNT	Mounting Kit for combustible countertops for HWB-11Q series only	4899
HWB-MNT-REC	Kit allows mounting to thick countertops - 8 Brackets (HWBI and HWB Rectangular Heated Wells only)	4970
HWB-MNT-RND	Kit allows mounting to thick countertops - 4 Brackets (Round Heated Wells only)	2485

External Manifold includes Individual Ball Valve for each Well (not available for the Slim models) –

HWBI2MANIF	2-Pan Accessory	₹ 48919
HWBI3MANIF	3-Pan Accessory	69438
HWBI4MANIF	4-Pan Accessory	89957
HWBI5MANIF	5-Pan Accessory	110476
HWBI6MANIF	6-Pan Accessory	130995

Necessary at your Well installation –

BALLVALVE3/4	High Temperature 3/4" NPT Ball Valve for units with Individual Drain(s) and no Manifold	₹ 6461
BALLVALVE1INCH	High Temperature 1" NPT Ball Valve for units with Manifold Drain (Ganged Heated Wells only)	4970
GATEVALVE3/4IN	High Temperature 3/4" NPT Gate Valve for units with Individual Drain(s) and no Manifold	7526
GATEVALVE1IN	High Temperature 1" NPT Gate Valve for units with Manifold Drain (Ganged Heated Wells only)	11076
HWB-RDHV	Heated Well Remote Handle for 3/4" NPT Drains only and includes a Ball Valve	25631



HWB-RDHV
Attaches to drain and includes a 3/4" ball valve

Countertop Heated Well

Providing versatility and reliability, Hatco Countertop Heated Wells hold food hot and fresh in either a wet or dry operation with an adjustable temperature control. The HW-FUL unit can hold a full-size pan or two half-size pans.

- Controls feature a separate lighted On/Off rocker switch and adjustable temperature dial
- May be used dry but best performance when used with water. Dry indicator lamp informs user to add water
- Thicker .8 mm stainless steel pan with a stainless steel housing (aluminized steel bottom)
- Pan edge offset helps keep condensation from dripping onto countertop surface

HW-FUL with accessory food pans and pan support bar



HOLD ONLY COUNTERTOP – FULL-SIZE

Model	Dimensions W x D x H	Voltage	Watts	Ship Weight†	List Price
Standard Watt					
HW-FUL	368 x 607 x 248 mm	230	1200	13 kg	₹35145

† Shipping weights are approximate.

All Hold Only Countertop Heated Well Models Feature:

Voltage: Single phase.

Cord Location: Bottom left corner on back of unit.

Models Shipped with: Stainless steel (aluminized stainless steel bottom) housing with a metal sheathed heating element, a power On/Off switch, a temperature control, a dry unit indicator light and a 1829 mm cord with plug attached.

ACCESSORIES (available for purchase at any time)

HW-2-7QT	Adapter to convert warmer to hold two 7-Liter Inserts	₹5396
HW-3-4QT	Adapter to convert warmer to hold three 4-Liter Inserts	5396
HW12BAR	305 mm Pan Support for Countertop Wells	1136
HW20BAR	508 mm Pan Support for Countertop Wells	1349

ADDITIONAL PAN AND LID ACCESSORIES – PAGES 36-37

HW - x x x

Heated Well ——— FUL = Full-Size Pan

Heat-Max Round Heated Wells

The multipurpose dry Heated Well from Hatco offers the flexibility of food warmers, soup kettles, Bain-Marie heaters, steamers and pasta cookers all in one! With a range of temperature settings, Heat-Max can boil pasta and soup noodles, steam dim sum and warm and hold soups, curry, gravies and toppings at safe-serving temperatures.

- Three temperature setpoints from 50°C to 100°C for warming, steaming and boiling
- Low power mode allows energy efficiency
- Single built-in model available (one 10-liter round pan)
- Freestanding units available as a single (one 10-liter round pan) or dual model (two 10-liter round pans) with individually-controlled pans



RHW-1B includes one well with 10-liter pot and hinged lid (ladle not included)



RHW-1 includes one well with 10-liter pot and hinged lid



RHW-2 includes two wells with two 10-liter pots and hinged lids (not shown)

Wells

FREESTANDING ROUND HEATED WELLS

Model	Voltage Single Phase	Dimensions W x D x H	kW	Ship Weight†	List Price
RHW-1	230	359 x 330 x 355 mm	1.3	9 kg	₹41322
RHW-2	230	630 x 330 x 355 mm	2.5	16 kg	66882

† Shipping weights are approximate.

All Freestanding Round Heated Well Models Feature:

Liquid Capacity: RHW-1: 10 liter pot. Actual pot capacity: 6 liters for boiling application or 8 liters for warming application.

RHW-2: 2 x 10 liter pots. Actual pot capacity: 2 x 6 liters for boiling application or 2 x 8 liters for warming application.

RHW-1 Shipped with: One food holding pan and one pan lid.

RHW-2 Shipped with: Two food holding pans and two pan lids.

Cord Location: 1829 mm cord and plug, back of unit.

BUILT-IN ROUND HEATED WELL

Model	Voltage Single Phase	Dimensions W x D x H	kW	Ship Weight†	List Price
RHW-1B	230	360 x 330 x 341 mm	1.3	10 kg	₹40186

† Shipping weights are approximate.

All Built-In Round Heated Well Models Feature:

Liquid Capacity: 10 liters. Actual pot capacity: 6 liters for boiling application or 8 liters for warming application.

RHW-1B Shipped with: One food holding pan, one pan lid and remote control.

Cord Location: 1422 mm cable from well to control box with a 1829 mm cord and plug located at the back of the control box.

Recommended Well Cut-Out Size: 305 mm diameter.

ACCESSORIES (pricing applies only at time of equipment purchase)

RHW-11QT-LID-HG	RHW Hinged Lid for 10-Liter Round Pan	₹5893
RHW-11QT-POT	RHW 10-Liter Round Pan	7810

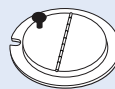

RHW-11QT-LID-HG
Hinged lid for 10-liter round pan

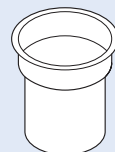

RHW-11QT-POT
10-liter round pan

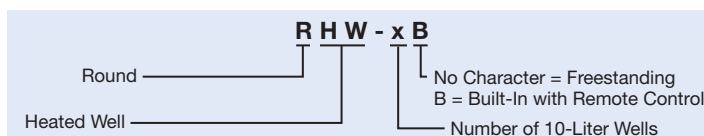

Heat-Max Rectangular Heated Wells

Now a wet Rectangular Hatco Heated Well that is a rethermalizer, a steamer or a Heated Well with a choice of a freestanding or a built-in model. An ideal Heat-Max Well for heating and holding your fresh or previously prepared foods at safe-serving temperatures.

- Three temperature setpoints from 50°C to 100°C for warming, steaming and boiling
- Low power mode allows energy efficiency
- Freestanding or built-in models
- Accessories include a soup kettle plate, a sauce warmer plate, pasta cooker plate, noodle basket and various round pans with lids



RCTHW-1



RCTHW-1B



RCTHW-6 with pasta cooker plate (not shown, see below)



RCTHW-6B with pasta cooker plate (not shown, see below)

FREESTANDING RECTANGULAR HEATED WELL

Model	Dimensions W x D x H	kW	Ship Weight†	List Price
RCTHW-1	368 x 611 x 282 mm	3	13 kg	₹45653

All Freestanding Rectangular Heated Well Models Feature:

Voltage: 230V, single phase.

Cord Location: 1830 mm cord and plug, back of unit.

BUILT-IN RECTANGULAR HEATED WELL

Model	Dimensions W x D x H	kW	Ship Weight†	List Price
RCTHW-1B	368 x 582 x 226 mm	3	12 kg	₹48919

All Built-In Rectangular Heated Well Models Feature:

Voltage: 230V, single phase.

RCTHW-1B Shipped with: Remote control.

Cord Location: 1420 mm cable from well to control box with a 1830 mm cord and plug located at the back of the control box.

Recommended Well Cut-Out Size: 550 mm W x 344 mm D.

FREESTANDING PASTA COOKER

Model	Dimensions W x D x H	kW	Ship Weight†	List Price
RCTHW-6	368 x 610 x 282 mm	6	16 kg	₹77532

BUILT-IN PASTA COOKER

Model	Dimensions W x D x H	kW	Ship Weight†	List Price
RCTHW-6B	390 x 610 x 301 mm	6	17 kg	₹80798

All Pasta Cookers Feature:

Voltage: 230V, single phase.

230/400V, three phase.

RCTHW-6 Shipped with: Auto-fill and RCTHW-PC.

RCTHW-6B Shipped with: Auto-fill, remote control, RCTHW-PC and 1420 mm cable from well to control box.

Power Location: Located on bottom of well, no cord supplied.

Recommended Well Cut-Out Size: 570 mm W x 344 mm D.

† Shipping weights are approximate on all models above.

ACCESSORIES (pricing applies only at time of equipment purchase)

RCTHW-SK	RCTHW Soup Kettle Plate (7-Liter Pot not included)	₹ 8378
RCTHW-SW	RCTHW Bain-Marie/Sauce Warmer Plate (4-Liter Pot not included)	8662
RCTHW-SP	RCTHW Steamer Plate (6 holes)	6887
RCTHW-PC	RCTHW Pasta Cooker Plate	12070
RCTHW-BASKET	RCTHW Noodle Basket with Stainless Steel Handle	1775
4QT-PAN	4-Liter Round Pan	6319
4QT-LID-1	4-Liter Round, Notched, Solid Lid	2982
7QT-PAN	7-Liter Round Pan	7029
7QT-LID-1	7-Liter Round, Notched, Solid Lid	3692



7QT-PAN
7-liter round pan

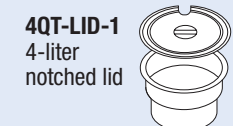

4QT-LID-1
4-liter round pan

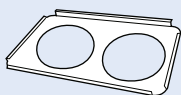

RCTHW-SK Soup kettle plate for the RCTHW

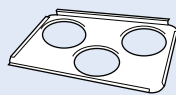

RCTHW-SW Bain-Marie/sauce warmer plate for the RCTHW

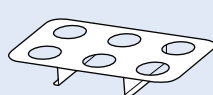

RCTHW-SP Steamer plate (6 holes) for the RCTHW

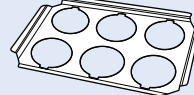

RCTHW-PC Pasta cooker plate for the RCTHW



RCTHW-Basket Noodle basket with stainless steel handle for the RCTHW

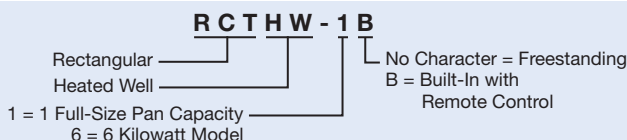

Decorative Lamps & Display Lights

*Cafeterias • Convenience Stores
Supermarkets & Delis • Restaurants & Cafes
Clubs & Bars • Concessions*



DL-1300-SR (DL-1200-SR in background)
in Clear Brushed Metal
Gloss finish *pg. 44-47*



DL-400-SN in Glossy Gray
Gloss finish *pg. 44-47*



DL-500-SR in Bright Brass
Plated finish *pg. 44-47*



DL-700-RL in Glossy Gray Gloss finish (sneeze
guards not available) *pg. 44-47*



DL-800-SR in *Designer* color Warm Red
pg. 44-47



DL-775-RL in Bright Nickel
Plated finish *pg. 44-47*



HLC5-66 in Standard Clear Anodized finish
(sneeze guards not available) *pg. 48*



Decorative Lamps & Display Lights

ORDERING INSTRUCTIONS

Luminaire lamps are for lighting only. LUMINAIRE option must be specified when lamps are utilized for decorative purposes only (no heating). This option is not field convertible. Maximum 100 watts.

CLEARANCE REQUIREMENTS

- NOTE:** Install 240V, 250W bulb no closer than 25 mm from a sidewall and no closer than 406 mm above a combustible surface, or no closer than 127 mm to a non-combustible surface.
- NOTE:** Install HIGH WATT 240V, 375W bulb no closer than 25 mm from a sidewall and no closer than 686 mm above a combustible surface, or no closer than 127 mm to a non-combustible surface (240V, 375W bulb not available).
- NOTE:** Multiple installations of Decorative Lamps must have a minimum of 305 mm on center of shade between each unit.

Specify the following information with your order:

1. **Electrical:** 240V single phase and Wattage 100W (Luminaire), 250W (Standard) or 375W (High Watt)
2. **Mounting Style Code:** A, C, P, R or S
3. **Switch Location Code:** Lower (L), None (N), Remote (R) or Upper (U), DLH models must have remote switch or none
4. **Shade Style Code:** -400, -500, -600, -700, -725, -750, -760, -775, -800, -1100, -1200, -1300, -1400, -1500
5. **Shade and Canopy Colors:** Warm Red, Black, Gray Granite, White Granite, Navy Blue, Hunter Green, Antique Copper, Smooth White, Gleaming Gold, Glossy Gray, Bold Black, Radiant Red* (lampshade only), Brilliant Blue* (lampshade only), Clear Coat Brushed Metal* (lampshade only), Bright Brass*, Bright Nickel*, Bright Copper*, Antique Nickel*, Antique Brass*, Antique Bronze*
6. **Overall Unit Length:** For C or S Mounts, from ceiling to bottom of warmer lamp shade
For A or P Mounts, from center of shade to wall plus vertical shade length
7. **Clearance:** From bulb to surface (see **NOTE** Clearance Requirements above)
8. **Accessory Bulb Color/Coating:** 40W Clear Coated (Luminaire only)
250W Clear Uncoated or Clear Coated (240V, 375W bulb not available)
9. **Cord Color:** Black (standard), White (optional)

* Special process required and extended lead times, see page 46 for additional charge. Specify your appropriate accessories with your order.

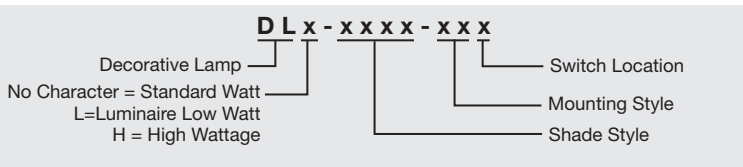
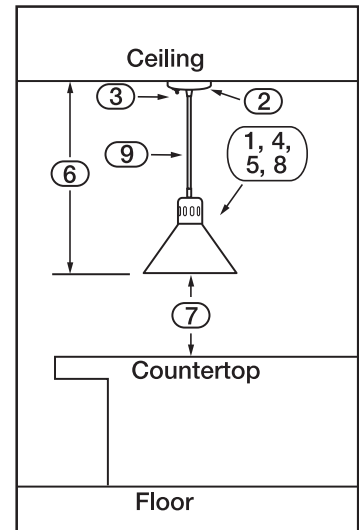

Decorative Lamps/ Luminaires

Hatco Decorative Lamps provide radiant heat to briefly hold food warm at kitchen work areas, waitress pickup stations or customer serving points, while enhancing your décor. Versatile enough for any location, from pick-up station to buffet lines, the range of lights are available with a selection of personalizing choices: shade styles, colors, switch locations and mounting arrangements. Configurations for lighting (Luminaire), as well as foodwarming, are available.

- Decorative Lamps are available in fourteen shade styles
- Five different mounting arrangements to choose from
- Available in seven *Designer Colors*, seven Gloss Finishes and six Plated Finishes
- Four power switch options: Upper (on canopy), Lower (at stem), Remote (shipped loose), None
- Available for food holding and display or lighting only applications

Rigid Stem Mount matches unit color (except for Gloss finishes of Radiant Red, Brilliant Blue and Clear Brushed Metal)

Black cord is standard and white cord is optional. Various cord lengths available, starting at 432 mm, while rigid and retractable can vary

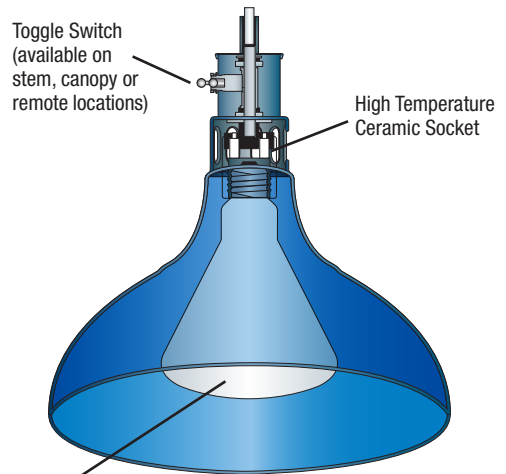

Bulbs:
40W clear coated (Luminaire only, 240V).
250W (DL models, 240V) in clear uncoated or coated
High watt bulb not available

NOTE: Decorative Lamps and Luminaires are non-returnable.

Decorative Lamps & Display Lights

Build A Decorative Lamp

Hatco has given you a variety of simple and easy ways to "Build Your Decorative Lamp." You can go online or quickly do the work tables of "How to Build Your Lamp" on pages 44 through 47.

- GO online at: www.hatcocorp.com and click on "Build a Lamp" under the resources Tab. (*Download a PDF of your lamp configuration in color and a Hatco List Price Quote*)
- OR follow the six steps in the Hatco Price List (next three pages) to build your Hatco model code and List Price. Then look at the following page for the accessories, like a bulb or track, to easily complete your total order.



Hatco Web Site shown, click on the Resources Tab and click on "Build A Lamp" configure your choices



HOW TO BUILD A LAMP



	Specify the following options when ordering:	
1 Electrical	DL	(Standard Watt - 250 watt max) No Charge
2 Mounting Style	C	(Cord Mount) No Charge
3 Switch Location	R	(Remote Switch Location) No Charge
4 Shade Style	-775	(See Shade Style on page 45) ₹26199
5 Shade Color	BBRASS	(Bright Brass Plated Finish) 10934
6 Overall Length	2032 mm	>1829 mm (₹14 over 1829 mm - only C Mounts) 1278
		TOTAL ₹38411

(Specify to the nearest inch – CL, CU, PL, PU, SL, SU mounts only).
Information indicated in red are items that the customer should enter. *Bulbs are not included.*

Now you can develop your own Hatco Decorative Lamp solutions with our online lamp configurator.

Visit www.hatcocorp.com
Click on "Build a Lamp"

Build A Decorative Lamp Configurator Worksheet

Complete the six steps on this worksheet to configure your Hatco model code and List Price. In order to get exactly what you need in the least amount of time, have this handy when ordering your Hatco Decorative Lamp.



Visit www.hatcocorp.com
Click on "Build a Lamp"

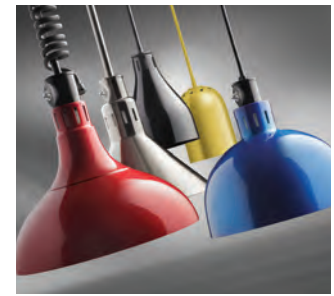

BUILD YOUR DECORATIVE/LUMINAIRE LAMPS – STEP 1 AND 2
(To determine your total list price and model code, pick all your options - bulb not included)

Decorative Lamps & Display Lights

MOUNTING STYLES		SPECIFY the:	Shade Height	
			216 mm	267 mm
ARM	A Mount Rigid Mount to canopy with pivot. 	Horizontal Stem Length	178 to 508 mm	
		Overall Length	Overall Length: 432 to 762 mm	Overall Length: 483 to 813 mm
PIVOT	P Mount Rigid Mount to canopy with pivot. 	Overall Length (From pivot to bottom of shade)	432 to 1803 mm	483 to 1854 mm
CORD	C Mount Cord Mount to canopy. 	Overall Length	432 mm to any length	483 mm to any length
RETRACTABLE CORD	R Mount Retractable Cord Mount. 	Adjusts to a maximum and minimum according to shade height	787 to 1765 mm	838 to 1816 mm
STEM	S Mount Rigid Stem Mount to canopy. 	Overall Length	356 to 1803 mm	406 to 1854 mm

STEP 1: VOLTAGE AND WATTAGE

Voltage	240V	No Charge
Wattage		No Charge
DLL- Luminaire	100 watt max	
DL- Standard	250 watt max	
DLH- High Watt	375 watt max	

STEP 2: MOUNTING STYLE

Mounting Style –		
A	Arm	₹ 4402
P	Pivot	4402
C	Cord (specify Cord Color)	No Charge
R	Retractable (specify Cord Color)	16188
S	Stem	4402

Rigid Stem Mounted (Knock down shipping on S and P units)

NOTE: Decorative Lamps and Luminaires are non-returnable.

DLx - xxx - xxx

- Decorative Lamp
- No Character = Standard Watt
- L=Luminaire Low Watt
- H = High Wattage
- Switch Location
- Mounting Style
- Shade Style

Go to next page for Steps 3-4.

Build A Decorative Lamp Configurator Worksheet

Continued page 44



BUILD YOUR DECORATIVE/LUMINAIRE LAMPS – STEP 3 AND 4
 (To determine your total list price and model code, pick all your options - bulb not included)

STEP 3: SWITCH LOCATION

Switch Location –	No Charge
L Lower (not available on high watt models)	
N None	
R Remote	
U Upper (not available on high watt models)	

SWITCH LOCATIONS

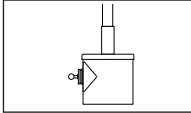

L - Lower Switch
 Not available on:
 • DLH (high watt models)
 • A Mount



R - Remote Switch
 • Accommodates 10 amps
 • Up to four 250W lamps maximum per remote switch

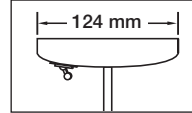

U - Upper Switch
 Not available on
 • DLH (high watt models)
 • R Mount

STEP 4: SHADE STYLE

Shade Code	Ship Weight (depending on components)	List Price
-400	3-5 kg	₹23998
-500	3-5 kg	23998
-600	3-5 kg	23998
-700	3-5 kg	23998
-725	3-5 kg	₹26199
-750	3-5 kg	26199
-760	3-5 kg	26199
-775	3-5 kg	26199
-800	3-5 kg	26199
-1100	3-5 kg	26199
-1200	3-5 kg	26199
-1300	3-5 kg	26199
-1400	3-5 kg	26199
-1500	3-5 kg	₹29820

SHADE STYLES (height and width shown)

Decorative Lamps & Display Lights

Go to next page for Steps 5-6.

NOTE: Decorative Lamps and Luminaires are non-returnable.

DL x - x x x x - x x x

Decorative Lamp ————
 No Character = Standard Watt
 L=Luminaire Low Watt
 H = High Wattage

Switch Location ————
 Mounting Style ————
 Shade Style ————

Build A Decorative Lamp Configurator Worksheet

Continued page 45

BUILD YOUR DECORATIVE/LUMINAIRE LAMPS – STEP 5 AND 6
 (To determine your total list price and model code, pick all your options - bulb not included)

SHADE AND CANOPY COLORS

Designer Colors

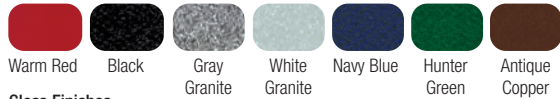

Gloss Finishes



Printed colors are a representation and may not exactly match our Designer, Gloss and Plated Finishes.

Plated Finishes – Special Process Required and Extended Lead Times



*Gloss Finishes for Shade Only – Special Process Required and Extended Lead Times



Exception: DL-1500 for Shade Only – Must choose other finish for remainder of unit



*Gloss and Plated Finishes – Special Process Required and Extended Lead Times
 *Plated Finishes – See Step 5, Plated Finishes for additional charge

STEP 5: SHADE AND CANOPY COLORS*

Shade and Canopy Colors –

Designer Colors No Charge

RED Warm Red	NAVY Navy Blue
BLACK Black	GREEN Hunter Green
GRAY Gray Granite	COPPER Antique Copper
WHITE White Granite	

Gloss Finishes No Charge

SWHITE Smooth White	GGRAY Glossy Gray
GGOLD Gleaming Gold	BBLACK Bold Black

*Gloss Finishes for Shade Only – (must choose other finish for remainder of unit) – Special Process Required and Extended Lead Times No Charge

RRED Radiant Red
BBLUE Brilliant Blue
CL-COAT Clear Brushed Metal

Special Process Required and Extended Lead Times – Plated Finishes –

BBRASS Bright Brass	₹10934
BNICKEL Bright Nickel	10934
BCOPPER Bright Copper	10934
ANICKEL Antique Nickel	10934
ABRASS Antique Brass	10934
ABRONZE Antique Bronze	10934

STEP 6: OVERALL LENGTH

Overall Length – For C Mounts, from ceiling to bottom of warmer lamp shade. For A or P Mounts, from center of shade to wall plus vertical shade length.

Up to 1829 mm	No Charge
Greater than 1829 mm (C Mount only)	₹1278

YOUR TOTAL LIST PRICE AND MODEL CODE

Add the total costs of options below (not for retrofit – bulb not included) –

Step 1 Electrical	₹ 0.00
Step 2 Mounting Style	<input type="text"/>
Step 3 Switch Location	0.00
Step 4 Shade Style	<input type="text"/>
Step 5 Shade and Canopy Colors	<input type="text"/>
Step 6 Overall Length	<input type="text"/>
Your Total Price (bulb not included)	₹ <input type="text"/>

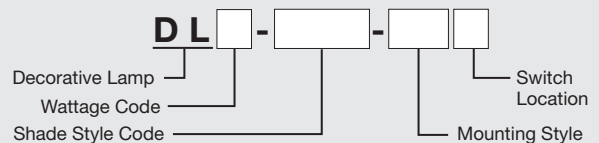

NOTE: Decorative Lamps and Luminares are non-returnable.

BULBS AND ACCESSORIES – PAGE 47



DL-750-RL in Clear Brushed Metal shade finish and unit in *Designer Black*

Decorative Lamps & Display Lights

OPTIONS (available at time of purchase only)

DL-CORD-WHITE White Cord (C=Cord, R=Retractable Mounts Only) (Black is standard) **No Charge**

Leads – For any SL, SR or SU Mount units, must specify Lead Length –		
LEADS5	305-1524 mm Extended Electrical Leads	₹1420
LEADS10	1829-3048 mm Extended Electrical Leads	2840
LEADS15	3353-4572 mm Extended Electrical Leads	4260
LEADS20	4877-6096 mm Extended Electrical Leads	5680

ACCESSORIES

WHITE-UCTD-240	240 Volt, 250 Watt Clear Bulb, Uncoated	each ₹3692
WHITE-CTD-240	240 Volt, 250 Watt Clear Bulb, Coated	each 4473
WHITE-CTD-240L	240 Volt, 40 Watt Clear Bulb, Coated (Luminaire models only)	each 781

NOTE: Decorative Lamps and Luminaires are non-returnable.

WHITE-CTD-240L



WHITE-UCTD-240
(240 volt, 250 watt clear bulb, uncoated)



WHITE-CTD-240
(240 volt, 250 watt clear bulb, coated)

Curved Display Lights

A stylish choice for illuminating your serving area. The Curved Display Light offers the highest light output that is ideal for illuminating food products using a neutral white 4000K light.

The sleek, curved design is patented and the LED lighting delivers significant savings with lower energy consumption and greater reliability. Hatco provides you with a wide variety of colors and lengths for any serving area.

- Features a patented curved housing design with energy efficient dual LED lights across the display lamp that provide longer performance and energy savings (compared to standard incandescent bulbs)
- Field replaceable dual LED lights
- Matches the Hatco line of Glo-Max® Curved Infrared Strip Heaters for a fully integrated look
- Angle brackets and 152 mm LED leads are standard
- Optional non-adjustable tubular stands and top or bottom mounting stands available

Decorative Lamps & Display Lights

HLC5-36
Clear Anodized (standard)
shown in top and underside views

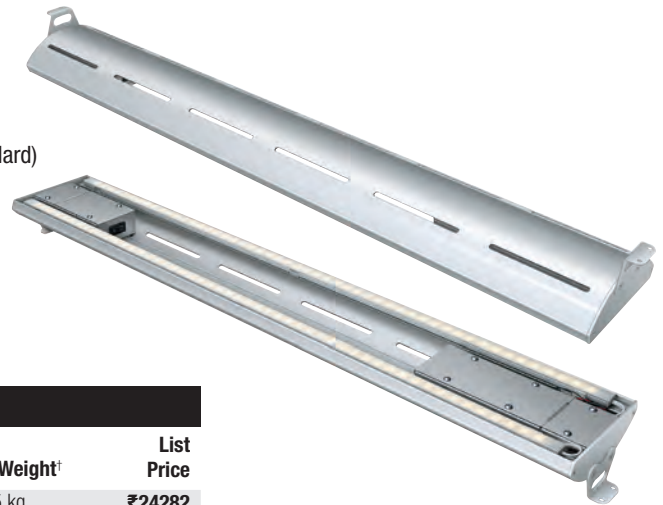

GLO-RITE® CURVED DISPLAY LIGHTS

Model	Standard Watt	Width	Voltage Single Phase	Watts	Amps	Ship Weight†	List Price
HLC5-30		762 mm	220-240	11-11	.05-.05	5 kg	₹24282
HLC5-36		915 mm	220-240	14-14	.06-.06	6 kg	25560
HLC5-42		1067 mm	220-240	15-16	.07-.07	6 kg	27122
HLC5-54		1372 mm	220-240	19-19	.08-.08	7 kg	30672
HLC5-66		1677 mm	220-240	22-22	.10-.09	8 kg	33654
HLC5-78		1982 mm	220-240	24-24	.11-.10	9 kg	38127

† Weights do not include shipping materials.

All Curved Display Light Models Feature:

Voltage: 220-240, single phase.

Models Shipped with: End panels, angle brackets with rocker switch under unit on power side.

Leads: 1524 mm leads - on power side.

Dimensions: 762 mm-1829 mm W x 150 mm D x 51 mm H (height includes standard angle bracket).

OPTIONS (available at time of purchase only)

Housing Color – Clear Anodized standard – End panels and Angle Brackets match unit color – Non-standard colors are non-returnable –

BLACKANOD Black Anodized per 305 mm ₹568

Non-Adjustable Tubular Stands, bottom mount, attach to counter – match unit color

NTL16-CLEAR Clear Anodized Non-Adjustable Tubular Stands 1 pair ₹2982

NTL16-BLACK Black Anodized Non-Adjustable Tubular Stands 1 pair 2982

HLC5 - x x

Curved Display Light Width (Inches)
Aluminum Housing



Save money lighting your
Hatco Glo-Ray® Strip Heater



GREEN ENERGY



Commit to going green in your foodservice operation with Hatco's patented Chef LED Bulbs! Heat strengthened glass lens protects the Light Emitting Diode (LED) while the exterior is made of rugged aluminum and prevents breakage of the components due to incidental contact in a busy kitchen environment. A Chef LED Bulb has substantial benefits and energy savings over other bulbs and are directional.



Other features include:

- Average of 184% increased light output, based on Foot Candle average delivered to surface from a height of 305 mm vs. 40 watt incandescent bulb
- Up to 91% energy savings vs. 40 watt incandescent bulb
- Unique design allows operation over a steam table
- 230V (50-60 Hz) offering
- Warranted for one year

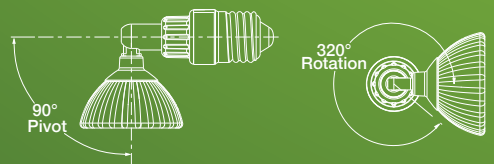

Go to www.hatcocorp.com and download the LED Cost Savings & Energy Analysis calculator to review your energy savings potential.



Scan to see how easy it is to install the Chef LED bulb, and direct the light, in your foodwarmer.



**CLED-2700
(Warm Light)**

3.5 watt

25,000 Hours*

Closest kelvin
Incandescent



**CLED-3000
(Warm Light)**

3.5 watt

25,000 Hours*

Closest kelvin
Halogen



**CLED-4000
(Cool Light)**

3.5 watt

25,000 Hours*

Closest kelvin
Fluorescent Tube

**BULB:
Halogen**

60 watt

1,500 Hours

**BULB:
Incandescent***

40 watt

3,000 Hours

*Appliance bulb

* With 75°C ambient air temperature.

Chef LED Bulbs can be used as an accessory in some equipment. For an up-to-date list call the factory.

Chef LED Bulbs – 230V adjustable bulb –

CLED-2700-230 Warm Incandescent

CLED-3000-230 Warm Halogen

CLED-4000-230 Cool Fluorescent

₹7171

Strip Heaters

*Cafeterias • Buffets • Supermarkets & Delis
Restaurants & Cafés • Clubs & Bars*



GM5AHL model in optional Black Anodized finish above a **GRS-54** pg. 52



GRAHL-72 with optional sneeze guards and non-adjustable tubular stands pg. 54



A series of **GRAH-60D** models pg. 56



GRAHL-42D with optional 152 mm spacer and non-adjustable tubular stands pg. 56



GRAHL-72D in optional *Designer Black* pg. 56



UGAH-42D with optional Gloss finish and standard 76 mm spacer. Remote Control Enclosure (RMB) recommended (not shown) pg. 59



GRAIH-72 pg. 61

Glo-Max® Curved Infrared Strip Heaters

This stylish design, based on Hatco's signature Glo-Max® Strip Heaters, is the perfect solution for your front-of-the-house applications. Superb for buffet and serving lines, the sleek curved design minimizes its size while accenting and warming the products below.

The entire holding surface is heated evenly with no "cold" spots thanks to Hatco's dependable infrared element technology.

- Narrow, curved design uses a very small footprint: 51 H x 153 D mm
- Widths available from 762 - 1981 mm
- Angle brackets (mounting) standard
- Pre-focused heat maintains safe serving temperatures longer without continuing to cook the food
- End panels and mounting brackets match unit color
- Includes Remote Control Enclosure (RMB)

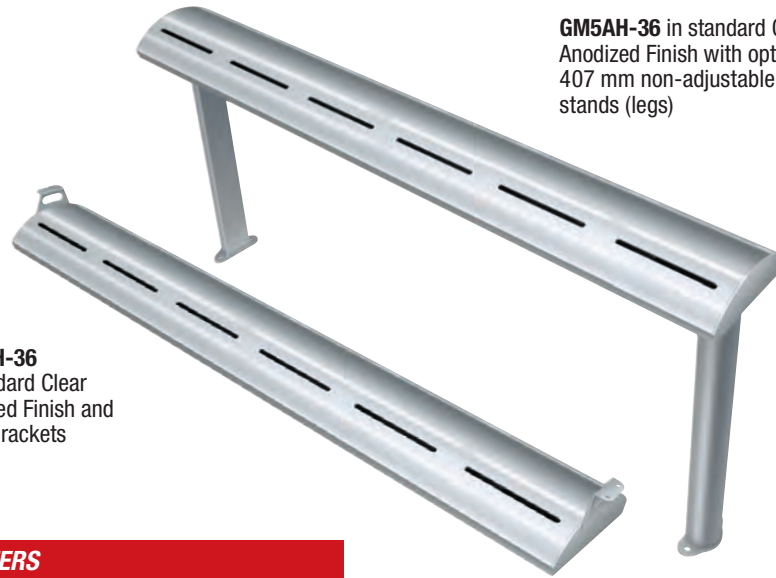

GM5AH-36 in standard Clear Anodized Finish with optional 407 mm non-adjustable tubular stands (legs)

GM5AH-36 in standard Clear Anodized Finish and angle brackets

GLO-MAX® CURVED INFRARED STRIP HEATERS

Model	Width	Watts 220-230V	Amps	Approx. Weight	List Price
High Watt					
GM5AH-30	762 mm	660-721	3.0-3.1	6 kg	₹23501
GM5AH-36	914 mm	800-874	3.6-3.8	7 kg	24850
GM5AH-42	1067 mm	950-1038	4.3-4.5	7 kg	26341
GM5AH-48	1219 mm	1100-1202	5.0-5.2	9 kg	27832
GM5AH-54	1372 mm	1250-1366	5.7-5.9	9 kg	29465
GM5AH-66	1676 mm	1560-1705	7.1-7.4	11 kg	34364
GM5AH-78	1981 mm	1890-2066	8.6-9.0	12 kg	39973

All Models Feature:

Switch Location: Remote Control Enclosure (RMB) with power On/Off switch included.

Leads: 1524 mm Power Leads.

Angle Brackets: Provides 25 mm clearance between Strip Heater and overshef.

Dimensions: 762-1981 W x 153 D x 51 H mm.

Control Box Dimensions: 190 W x 68 mm H.

Cut Out Dimensions: 162 W x 51 H mm.

OPTIONS (available at time of purchase only)

Housing Color – End panels and Angle Brackets match unit color – Clear Anodized standard – Non-standard colors are non-returnable –

BLACKANOD Black Anodized per 305 mm ₹ 568

Non-Adjustable Tubular Stands, bottom mount, attach to counter – match unit color

NTL5-16 407 mm clearance 1 pair 2982

RECOMMENDED MOUNTING HEIGHTS – PAGE 65

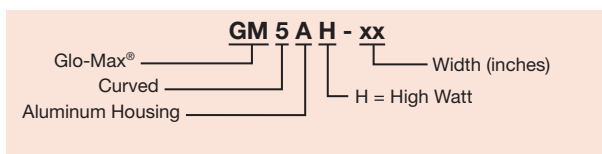

Strip Heaters

Glo-Max® Curved Infrared Strip Heaters with LED Lights

Hatco's Glo-Max® Curved Infrared Strip Heaters with LED Lights feature a housing design that is low-profile, elliptical-shaped and stylish, the ideal solution for front-of-the-house applications where heat and lights are needed.

- Narrow, curved design: 51 H x 153 D mm uses a very small footprint
- Lengths available from 762-1981 mm
- Energy efficient, warm LED lights span the entire strip heater, which provide longer performance and energy savings compared to standard incandescent bulbs
- Angle Brackets (mounting) standard
- End panels and Angle Brackets match unit color
- Includes Remote Control Enclosure (RMB) with power On/Off switch (controls lights and heat)
- Pre-focused heat maintains safe serving temperatures longer without continuing to cook the food



GM5AHL-36 Top and bottom view. Shown in optional Black Anodized Finish and standard Angle Brackets.

Strip Heaters

GLO-MAX® CURVED INFRARED STRIP HEATERS WITH LED LIGHTS

Model	Width	Watts 220-230V	Amps	Approx. Weight	List Price
High Watt					
GM5AHL-30	762 mm	671-733	3.1-3.2	6 kg	₹37275
GM5AHL-36	914 mm	813 - 889	3.7-3.9	7 kg	40825
GM5AHL-42	1067 mm	964-1054	4.4-4.6	7 kg	44588
GM5AHL-48	1219 mm	1116-1220	5.1-5.3	7 kg	49203
GM5AHL-54	1372 mm	1267-1385	5.8- 6.0	9 kg	52611
GM5AHL-66	1676 mm	1579-1726	7.2- 7.5	11 kg	62409
GM5AHL-78	1981 mm	1911-2089	8.7- 9.1	12 kg	73840

All Models Feature:

Switch Location: Remote Control Enclosure (RMB) with power On/Off switch (controls lights and heat) included.
Leads: 1524 mm Power Leads

Angle Brackets: Provides 25 mm clearance between strip heater and overshef.

Dimensions: 762-1981 W x 153 D x 51 H mm.

Control Box Dimensions: 190 W x 68 H mm.

Cut Out Dimensions: 162 W x 51 H mm.

OPTIONS – PAGE 53





OPTIONS (available at time of purchase only)

Housing Color – End panels and Angle Brackets match unit color – Clear Anodized standard – Non-standard colors are non-returnable –

BLACKANOD Black Anodized per 305 mm ₹ 568

Non-Adjustable Tubular Stands, bottom mount, attach to counter – match unit color

NLT5-16 407 mm clearance 1 pair 2982

RECOMMENDED MOUNTING HEIGHTS – PAGE 65

A GM5AHL model in optional Black Anodized finish above a GRS-54

Glo-Ray® Infrared Strip Heaters

Safely hold the temperature of your product without drying out or further cooking food with Hatco's Glo-Ray® Infrared Foodwarmers. The end result is hot, fresh food that's ready-to-serve. The sturdy stainless steel or continuous aluminum housing and heavy-duty mountings ensure the durability and quality of Hatco products.

- Ensures maximum flavor, safety and holding time
- Provides even heat distribution – no cold spots
- Sturdy extruded aluminum housings that do not sag, from 457 to 1829 mm
- Reflector does not blacken, maintaining a consistent heat pattern
- Protective reinforced wire guard supports heating element without affecting heat distribution
- Heavy-duty insulation minimizes heat loss
- Optional sneeze guards (excludes stainless steel models)
- Available with lights (excludes stainless steel models)
- Available in stainless steel housing 457 to 1829 mm
- Additional reflector styles and lower wattage elements available, consult factory for more information

STAINLESS STEEL STRIP HEATERS – HIGH WATT

Model [^]	Dimensions W x D x H	Voltage Single Phase 220V Amps	Watts	Ship Weight	List Price
GRH-18	457 x 152 x 69 mm	1.6	350	4 kg	₹27690
GRH-24	610 x 152 x 69 mm	2.3	500	4 kg	29110
GRH-36	914 x 152 x 69 mm	3.6	800	5 kg	32802
GRH-48	1219 x 152 x 69 mm	5.0	1100	6 kg	35642
GRH-60	1524 x 152 x 69 mm	6.4	1400	8 kg	40186
GRH-72	1829 x 152 x 69 mm	7.8	1725	9 kg	47641
GRH-96	2438 x 152 x 69 mm	10.9	2400	11 kg	57510

[^]GRH models are not available with lights or sneeze guards.

All Stainless Steel Models Feature:

Toggle Switch (max. 15 Amps) Location: Chef's left side.

Leads: 152 mm pigtail leads – server's right.



GRAH-48 with optional sneeze guards, cord and plug set and T-leg Stands



GRAH-24



GRAH-36 with optional Navy Blue Designer color, infinite switch, cord and plug set and accessory C-leg Stands

ALUMINUM STRIP HEATERS – HIGH WATT

Model	Dimensions W x D x H	Voltage Single Phase 220V Amps	Watts	Ship Weight	List Price
GRAH-18	457 x 152 x 64 mm	1.6	350	4 kg	₹19028
GRAH-24	610 x 152 x 64 mm	2.3	500	4 kg	20022
GRAH-30	762 x 152 x 64 mm	3.3	660	4 kg	21371
GRAH-36	914 x 152 x 64 mm	3.6	800	5 kg	22578
GRAH-42	1067 x 152 x 64 mm	4.3	950	5 kg	23998
GRAH-48	1219 x 152 x 64 mm	5.5	1100	5 kg	25276
GRAH-54	1372 x 152 x 64 mm	5.7	1250	6 kg	26909
GRAH-60	1524 x 152 x 64 mm	6.4	1400	7 kg	28684
GRAH-66	1676 x 152 x 64 mm	7.1	1560	8 kg	31524
GRAH-72	1829 x 152 x 64 mm	7.8	1725	8 kg	35429
GRAH-84	2134 x 152 x 64 mm	9.3	2050	9 kg	40825
GRAH-96	2438 x 152 x 64 mm	10.9	2400	10 kg	46434

All Aluminum Models Feature:

Toggle Switch (max. 15 Amps) Location: Chef's left side (unless otherwise specified).

Leads: 152 mm pigtail leads – server's right.

ALUMINUM STRIP HEATERS WITH LIGHTS – HIGH WATT

Model	Bulbs	Dimensions W x D x H	Voltage Single Phase 220V Amps	Watts	Ship Weight	List Price
GRAHL-18	2	457 x 229 x 64 mm	2.1	470	4 kg	₹29749
GRAHL-24	2	610 x 229 x 64 mm	2.9	620	5 kg	30885
GRAHL-30	2	762 x 229 x 64 mm	3.6	780	5 kg	34293
GRAHL-36	3	914 x 229 x 64 mm	4.5	980	6 kg	37701
GRAHL-42	3	1067 x 229 x 64 mm	5.2	1130	8 kg	41180
GRAHL-48	4	1219 x 229 x 64 mm	6.2	1340	8 kg	44730
GRAHL-54	4	1372 x 229 x 64 mm	6.9	1490	9 kg	48706
GRAHL-60	5	1524 x 229 x 64 mm	7.8	1700	10 kg	52895
GRAHL-66	5	1676 x 229 x 64 mm	8.6	1860	10 kg	57865
GRAHL-72	6	1829 x 229 x 64 mm	9.6	2085	16 kg	64397
GRAHL-84	7	2134 x 229 x 64 mm	8.6	2470	18 kg	74195
GRAHL-96	8	2438 x 229 x 64 mm	13.3	2880	25 kg	84135

All Aluminum Models with Lights Feature:

Toggle Switch (max. 15 Amps) Location: Chef's left side – light side (unless otherwise specified).

Leads: 152 mm pigtail leads – server's right.

OPTIONS AND ACCESSORIES – PAGE 55
RECOMMENDED MOUNTING HEIGHTS – PAGE 65

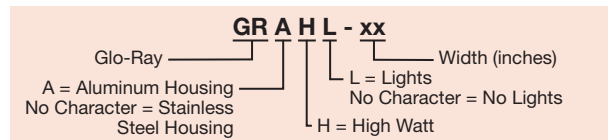

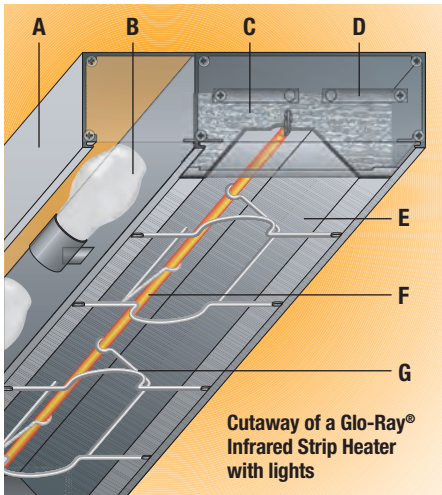

- A** Stainless steel or sturdy aluminum housings that do not sag, from 457 up to 1829 mm in 153 mm increments. Stainless units available in single units without lights, up to 1829 mm in width
- B** Shatter-resistant incandescent lights (standard on GRAHL)
- C** Heavy-duty insulation minimizes heat loss
- D** Standard hanger tabs are provided
- E** Aluminized reflector retains full heat intensity and directs more heat towards the edges of the holding surface
- F** Long life metal sheathed heating element
- G** Wire guard supports the heating element and provides operator safety without affecting heat distribution

OPTIONS (available at time of purchase only)

Designer colors, aluminum models 457-1829 mm – Clear Anodized Standard – Non-standard colors are non-returnable –

COLOR-6	152 mm Housing for GRAH models							per 305 mm	₹1775
COLOR-9	229 mm Housing for GRAHL models							per 305 mm	1775
	RED Warm Red	GRAY Gray Granite	NAVY Navy Blue	COPPER Antique Copper					
	BLACK Black	WHITE White Granite	GREEN Hunter Green						

Gloss Finishes, aluminum models 457-1829 mm – Clear Anodized Standard – Non-standard colors are non-returnable –

GLOSS-6	152 mm Housing for GRAH models							per 305 mm	₹2414
GLOSS-9	229 mm Housing for GRAHL models							per 305 mm	2414
	RRED Radiant Red	GGRAY Glossy Gray	BBLACK Bold Black						
	GGOLD Gleaming Gold	BBLUE Brilliant Blue							

CAP-EX	Attached 1829 mm Cord and Plug Set on models up to 1829 mm								₹2059
IND. LGT	Indicator Light (remote control only on stainless steel units)								1065

Extended Electrical Leads (Power) – Must specify lead length –

LEADS5	305-1525 mm Extended Electrical Leads								₹1420
LEADS10	1829-3048 mm Extended Electrical Leads								2840
LEADS15	3352-4572 mm Extended Electrical Leads								4260
LEADS20	4877-6096 mm Extended Electrical Leads								5680

9.375BP1	238 mm Sneeze Guard – one side							per 305 mm	₹ 3905
9.375BP2	238 mm Sneeze Guard – two sides							per 305 mm	7810
14BP1	356 mm Sneeze Guard – one side							per 305 mm	6319
14BP2	356 mm Sneeze Guard – two sides							per 305 mm	12638

NO BULB	No bulb Option (GRAHL 230V models only)								No Charge
LIGHTS-ADD'L	Extra Lamps – Installed (max. two per 305 mm less one – one per 305 mm is standard), must be ordered with remote switches only							each	1775
3 ANEAL REFL	Bright Annealed Reflector for lights							per 305 mm	1491

Infinite Control (REMOTE ENCLOSURE RECOMMENDED)

BLT INF	Built-In (max. of 12.2 Amps) – remote installation recommended								₹2627
----------------	--	--	--	--	--	--	--	--	-------

Remote Control Enclosure (RMB) – available in Designer colors and Gloss finishes – Clear Anodized Standard – Non-standard colors are non-returnable –

See Page 64 for models and prices

ATL	Adjustable Tubular Stands 254-356 mm (not available in Designer colors)							pair	₹13561
NTL-10, -12	Non-Adjustable Tubular Stands (specify 254 or 305 mm clearance)							pair	6319
NTL-14, -16	Non-Adjustable Tubular Stands (specify 356 or 406 mm clearance)							pair	6745
NTL-PAINT	Non-Adjustable Tubular Stand (specify Designer color or Gloss finish) – Clear Anodized Standard – Non-standard colors are non-returnable –							pair	2556
TL-13	T-Leg Stands (343 mm clearance) for models up to 1829 mm							pair	19170
TL-16	T-Leg Stands (406 mm clearance) for models up to 1829 mm							pair	20448
TL-18	T-Leg Stands (457 mm clearance) for models up to 1829 mm							pair	21868

ACCESSORIES – see page 63 for illustrations

CL-HIGH	C-Leg Stands High Watt – 343 mm clearance (for models up to 1829 mm)							pair	₹8094
GR-ANGLE	Adjustable Angle Brackets for GRH models only							pair	1704
ADJ ANGLE	Adjustable Angle Brackets for GRAH, GRAHL models only							pair	1704
ADJ ANGLE7	178 mm tall Adjustable Angle Bracket for GRAH, GRAHL models only							pair	1917
CHAIN 1	Chain Suspension							per 305 mm	639

COLORS AND FINISHES – INSIDE BACK COVER

Strip Heaters

Glo-Ray® Dual Infrared Strip Heaters

Create a deeper holding area with Glo-Ray® Aluminum Dual Infrared Strip Heaters mounted side-by-side, keeping hot food at optimum serving temperatures. The pre-focused heat pattern directs heat from a metal sheathed element across the entire holding surface. The continuous aluminum housing and heavy-duty mountings ensure the durability and quality of Hatco products.

- Ensures maximum flavor, safety and holding time
- Provides even heat distribution – no cold spots
- Sturdy extruded aluminum housings that do not sag, from 457 to 1829 mm
- Long life metal sheathed heating elements
- Reflector does not blacken, maintaining a consistent heat pattern

- Reinforced wire guard provides operator safety without affecting heat distribution
- 76 or 152 mm spacer available
- Additional reflector styles and lower wattage elements available, consult factory for more information



GRAH-36D with standard 76 mm spacer

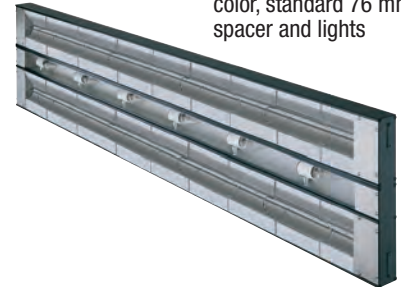

GRAHL-72D with optional *Designer* color, standard 76 mm spacer and lights

ALUMINUM DUAL STRIP HEATERS – HIGH WATT

Model	Width	Voltage Single Phase		Ship Weight	List Price	
		220V Amps	Watts		76 mm Spacer	152 mm Spacer
GRAH-18D	457 mm	3.2	700	7 kg	₹ 46718	₹ 47428
GRAH-24D	610 mm	4.5	1000	8 kg	48777	49487
GRAH-30D	762 mm	6.0	1320	9 kg	53676	54741
GRAH-36D	914 mm	7.3	1600	9 kg	58717	59782
GRAH-42D	1067 mm	8.6	1900	11 kg	63758	64823
GRAH-48D	1219 mm	10.0	2200	13 kg	68728	70148
GRAH-54D	1372 mm	11.4	2500	14 kg	73485	74905
GRAH-60D	1524 mm	12.7	2800	16 kg	79236	81366
GRAH-66D	1676 mm	14.2	3120	18 kg	86904	89034
GRAH-72D	1829 mm	15.7	3450	19 kg	97128	99258
GRAH-84D	2134 mm	18.6	4100	23 kg	112180	115020
GRAH-96D	2438 mm	21.8	4800	24 kg	127587	130427

All Aluminum Dual Models Feature:

Toggle Switch (max. 15 Amps) Location: Chef's left side (unless otherwise specified).

Leads: 152 mm pigtail leads – server's right.

Dimensions: With 76 mm Spacer (standard): 457-1829 W x 381 D x 64 H mm.

With 152 mm Spacer: 457-1829 W x 457 D x 64 H mm.

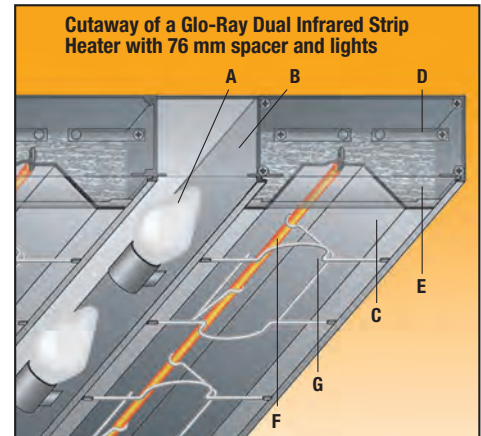

- A Shown with optional shatter-resistant incandescent lights
- B Sturdy extruded aluminum housings that do not sag, from 457 up to 1829 mm
- C Reflector does not blacken, maintaining a consistent heat pattern
- D Standard hanger tab is provided for under shelf or chain installation
- E Heavy-duty insulation minimizes heat loss
- F Long life metal sheathed heating elements
- G Protective reinforced wire guard supports heating element without affecting heat distribution

ALUMINUM DUAL STRIP HEATERS WITH LIGHTS – HIGH WATT

Model	Bulbs	Width	Voltage Single Phase		Ship Weight	List Price	
			220V Amps	Watts		76 mm Spacer	152 mm Spacer
GRAHL-18D	2	457 mm	3.7	820	7 kg	₹ 51688	₹ 52398
GRAHL-24D	2	610 mm	5.1	1120	8 kg	53463	54173
GRAHL-30D	2	762 mm	6.5	1440	9 kg	59498	60563
GRAHL-36D	3	914 mm	8.1	1780	10 kg	65604	66669
GRAHL-42D	3	1067 mm	9.5	2080	12 kg	71852	72917
GRAHL-48D	4	1219 mm	11.1	2440	14 kg	78242	79662
GRAHL-54D	4	1372 mm	12.5	2740	15 kg	84987	86407
GRAHL-60D	5	1524 mm	14.1	3100	17 kg	92229	94359
GRAHL-66D	5	1676 mm	15.5	3420	18 kg	100891	103021
GRAHL-72D	6	1829 mm	17.3	3810	20 kg	112677	114807
GRAHL-84D	7	2134 mm	20.5	4520	23 kg	130356	133196
GRAHL-96D	8	2438 mm	24.0	5280	25 kg	147467	150307

All Aluminum Dual Models with Lights Feature:

Toggle Switch (max. 15 Amps) Location: Chef's left side (unless otherwise specified).

Leads: 152 mm pigtail leads – server's right.

Dimensions: With 76 mm Spacer (standard): 457-1829 W x 381 D x 64 H mm.

With 152 mm Spacer: 457-1829 W x 457 D x 64 H mm.

OPTIONS AND ACCESSORIES – PAGE 57
RECOMMENDED MOUNTING HEIGHTS – PAGE 65

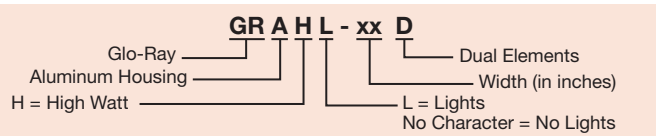



A series of **GRAH-60D** models

OPTIONS (available at time of purchase only)

Designer colors, aluminum models 457-1829 mm – Non-standard colors are non-returnable – Clear Anodized standard –

COLOR-15, -18	381 and 457 mm Housings for GRAH and GRAHL Dual models					per 305 mm	₹2556
RED	Warm Red	GRAY	Gray Granite	NAVY	Navy Blue	COPPER	Antique Copper
BLACK	Black	WHITE	White Granite	GREEN	Hunter Green		

Gloss finishes, aluminum models 457-1829 mm – Non-standard colors are non-returnable – Clear Anodized standard –

GLOSS-15, -18	381 and 457 mm Housings for GRAH and GRAHL Dual models					per 305 mm	₹3266
RRED	Radiant Red	GGRAY	Glossy Gray	BBLACK	Bold Black		
GGOLD	Gleaming Gold	BBLUE	Brilliant Blue				

IND. LGT	Indicator Light (remote only)						1065
-----------------	-------------------------------	--	--	--	--	--	------

Extended Electrical Leads (Power) – Must specify lead length –

LEADS5	305-1525 mm Extended Electrical Leads						₹1420
LEADS10	1829-3048 mm Extended Electrical Leads						2840
LEADS15	3352-4572 mm Extended Electrical Leads						4260
LEADS20	4877-6096 mm Extended Electrical Leads						5680

9.375BP1	238 mm Sneeze Guard – one side					per 305 mm	₹ 3905
9.375BP2	238 mm Sneeze Guard – two sides					per 305 mm	7810
14BP1	356 mm Sneeze Guard – one side					per 305 mm	6319
14BP2	356 mm Sneeze Guard – two sides					per 305 mm	12638

NO BULB	No bulb Option (GRAHL-xxD 230V models only)						No Charge
----------------	---	--	--	--	--	--	-----------

LIGHTS-ADD'L	Extra Lamps – Installed (max. two per 305 mm less one), one per 305 mm is standard					each	1775
---------------------	--	--	--	--	--	------	------

3 ANEAL REFL	Bright Annealed Reflector for lights with 76 mm Spacer					per 305 mm	1491
---------------------	--	--	--	--	--	------------	------

6 ANEAL REFL	Bright Annealed Reflector for lights with 152 mm Spacer					per 305 mm	2201
---------------------	---	--	--	--	--	------------	------

Remote Control Enclosure (RMB) – available in Designer colors and Gloss finishes – Clear Anodized Standard – Non-standard colors are non-returnable –

See page 64 for models and prices

RMB-ATT	Factory attaches Remote Control Enclosure to Strip Heater (GRAH, GRAHL Dual models only) (must select RMB on page 64 and add cost)						₹ 2485
----------------	--	--	--	--	--	--	--------

ATL-D	Adjustable Tubular Stands 254-356 mm (not available in Designer colors)					2 pair	27122
--------------	---	--	--	--	--	--------	-------

NTL-10-D, -12-D	Non-Adjustable Tubular Stands (specify 254 or 305 mm clearance)					2 pair	12638
------------------------	---	--	--	--	--	--------	-------

NTL-14-D, -16-D	Non-Adjustable Tubular Stands (specify 356 or 406 mm clearance)					2 pair	13490
------------------------	---	--	--	--	--	--------	-------

NTL-PAINT-D	Non-Adjustable Tubular Stands in Designer color or Gloss finish (specify color or finish) – Clear Anodized Standard – Non-standard colors are non-returnable –					2 pair	5112
--------------------	--	--	--	--	--	--------	------

ACCESSORIES – see page 63 for illustrations

ADJ ANGLE-D	Adjustable Angle Brackets					2 pair	₹3408
--------------------	---------------------------	--	--	--	--	--------	-------

ADJ ANGLE7-D	178 mm tall Adjustable Angle Brackets					2 pair	3834
---------------------	---------------------------------------	--	--	--	--	--------	------

CHAIN 1	Chain Suspension					per 305 mm	639
----------------	------------------	--	--	--	--	------------	-----

COLORS AND FINISHES – INSIDE BACK COVER

Strip Heaters

Ultra-Glo® Ceramic Infrared Strip Heaters

Hatco Ultra-Glo® Ceramic Strip Heaters provide the ultimate holding power. Increased heights improve working clearances and the heat zone blankets the entire holding area. All models include adjustable angle brackets for mounting. Available with or without lights, with attached or Remote Control Enclosure (RMB) (recommended). Ideal for a fabricator who wants to incorporate a food warmer component into their final assembly.

- Pre-focused pyramidal heat pattern concentrates the heat at the edges where heat loss is the greatest
- Increased height improves operational working clearances, giving the chef and server an improved ergonomic working environment
- Available in widths from 457 to 1829 mm
- Adaptable to many locations and configurations, including back-or front-of-the-house use, open kitchen concepts or buffet lines
- Optional coated shatter-resistant incandescent bulbs enhance product displays while safeguarding food from bulb breakage



UGAH-18 with optional Gloss finish – recommended with Remote Control Enclosure (RMB) (not shown)

Strip Heaters

ALUMINUM CERAMIC STRIP HEATERS – HIGH WATT Standard Control Box includes toggle switch(es) and Indicator Light(s)

Model	Width	Voltage Single Phase	Watts	Amps	Ship Weight [◇]	List Price [■]
UGAH-18	457 mm	220	630	2.9	5 kg	₹44233
UGAH-24	610 mm	220	756	3.4	4 kg	44872
UGAH-30	762 mm	220	945	4.7	5 kg	54031
UGAH-36	914 mm	220	1260	5.7	7 kg	54386
UGAH-42	1067 mm	220	1680	7.6	7 kg	63403
UGAH-48	1219 mm	220	1890	8.6	9 kg	64042
UGAH-54	1372 mm	220	2268	10.3	9 kg	72349
UGAH-60	1524 mm	220	2520	11.5	11 kg	73201
UGAH-66	1676 mm	220	2520	11.5	10 kg	81792
UGAH-72	1829 mm	220	3025	13.8	11 kg	83567

ALUMINUM CERAMIC STRIP HEATERS WITH LIGHTS – HIGH WATT

Model	Bulbs	Width	Voltage Single Phase	Watts	Amps	Ship Weight [◇]	List Price [*]
UGAHL-18	1	457 mm	220	680	3.1	5 kg	₹ 54173
UGAHL-24	2	610 mm	220	856	3.9	5 kg	55167
UGAHL-30	2	762 mm	220	1045	4.8	8 kg	66243
UGAHL-36	3	914 mm	220	1410	6.4	8 kg	68941
UGAHL-42	3	1067 mm	220	1830	8.3	9 kg	79307
UGAHL-48	4	1219 mm	220	2090	9.5	10 kg	82076
UGAHL-54	4	1372 mm	220	2468	11.2	11 kg	92655
UGAHL-60	5	1524 mm	220	2770	12.6	12 kg	96205
UGAHL-66	5	1676 mm	220	2770	12.6	14 kg	105861
UGAHL-72	6	1829 mm	220	3324	15.1	15 kg	109340

◇ Does not include Remote Control Enclosure (RMB).

■ Includes either attached control or Remote Control Enclosure (RMB) with toggle switch(es) and indicator light(s).

* Units with lights not available with attached control box. Available with Remote Control Enclosure (RMB) (not included in unit price) or no switches.

All Ceramic Models Feature:

Models shipped with: Angle Brackets with 152 mm Leads.

UGAH Dimensions with Remote Control Enclosure, (RMB) Toggle and Indicator Light:
457-1829 W x 152 D x 64 H mm.

UGAHL Dimensions with Remote Control Enclosure (RMB), Toggle and Indicator Light:
457-1829 W x 229 D x 64 H mm.

UGAH Dimensions with Attached Box: 457-1829 W x 251 D x 64 H mm.

OPTIONS – PAGE 60

REMOTE CONTROL ENCLOSURES (RMBs) – PAGE 64

RECOMMENDED MOUNTING HEIGHTS – PAGE 65

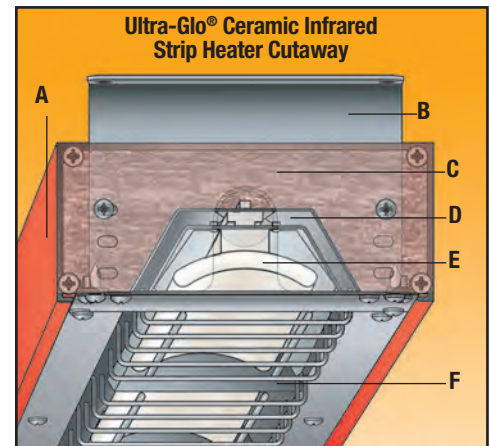

A Sturdy aluminum housings that do not sag, widths from 457 up to 1829 mm in 152 mm increments

B Adjustable standard mounting bracket (allows three different mounting heights and allows connection to end of the unit)

C Heavy-duty insulation surrounds heating element to keep exterior housing cooler and minimize heat loss

D Dual aluminized steel reflector keeps housing cooler, focuses more heat towards the food

E Shape of element focuses the heat on the food

F Protective wire guards under heating element

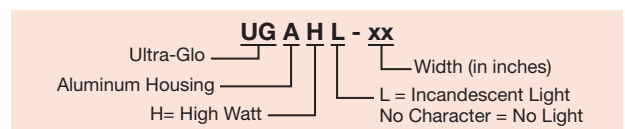

Ultra-Glo® Ceramic Dual Infrared Strip Heaters

Hatco Ultra-Glo® Ceramic Strip Heaters provide the ultimate holding power. Increased height improves working clearances and the heat zone blankets the entire holding area. All models include adjustable angle brackets for mounting. Dual mounted Strip Heaters accommodate wider food holding areas. Ideal for a fabricator who wants to incorporate a foodwarmer component into their final assembly.

- Increased height that the ceramic heat source affords, improves operational working clearances, giving the chef and server an improved ergonomic environment in which to work
- Adaptable to any location and configuration, including back- or front-of-the-house use, open kitchen concepts or buffet lines
- Sturdy continuous aluminum housings
- Available in widths from 457 to 1829 mm
- Pre-focused heat pattern provides an increased pyramidal dimension, concentrating heat at the edges where heat loss is the greatest

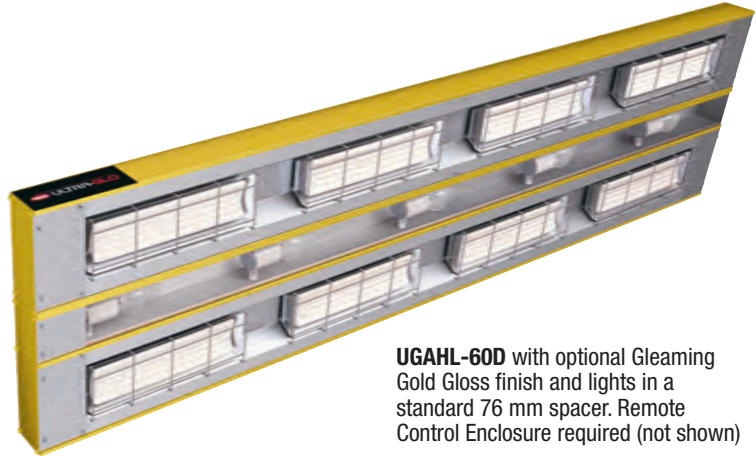

UGAHL-60D with optional Gleaming Gold Gloss finish and lights in a standard 76 mm spacer. Remote Control Enclosure required (not shown)

ALUMINUM DUAL CERAMIC STRIP HEATERS – HIGH WATT

Standard Control Box includes toggle switch(es) and indicator light(s)

Model	Width	Voltage (Single Phase)	Watts	Ship Weight [◇]	List Price [■]
UGAH-18D	457 mm	220	1260	8 kg	₹ 87898
UGAH-24D	610 mm	220	1512	9 kg	91590
UGAH-30D	762 mm	220	1890	11 kg	110973
UGAH-36D	914 mm	220	2520	14 kg	114452
UGAH-42D	1067 mm	220	3360	15 kg	134048
UGAH-48D	1219 mm	220	3780	18 kg	137456
UGAH-54D	1372 mm	220	4536	19 kg	156413
UGAH-60D	1524 mm	220	5040	22 kg	160673
UGAH-66D	1676 mm	220	5040	23 kg	179488
UGAH-72D	1829 mm	220	6048	25 kg	185026

ALUMINUM DUAL CERAMIC STRIP HEATERS WITH LIGHTS – HIGH WATT

Model	Bulbs	Width	Voltage (Single Phase)	Watts	Ship Weight [◇]	List Price [*]
UGAHL-18D	1	457 mm	220	1310	8 kg	₹ 92087
UGAHL-24D	2	610 mm	220	1612	7 kg	93933
UGAHL-30D	2	762 mm	220	1990	11 kg	116795
UGAHL-36D	3	914 mm	220	2670	12 kg	121907
UGAHL-42D	3	1067 mm	220	3510	15 kg	143349
UGAHL-48D	4	1219 mm	220	3980	16 kg	147751
UGAHL-54D	4	1372 mm	220	4736	20 kg	168838
UGAHL-60D	5	1524 mm	220	5290	22 kg	173666
UGAHL-66D	5	1676 mm	220	5290	23 kg	194043
UGAHL-72D	6	1829 mm	220	6348	26 kg	201001

◇ Does not include Remote Control Enclosure.
 ■ Includes either attached control or Remote Control Enclosure with toggle switch(es) and indicator light(s).
 * Units with lights will be supplied with Remote Control Enclosure or without switches.

All Ceramic Dual Models Feature:

Models Shipped with: Angle Brackets and Leads (914 mm Leads).
 Dimensions with Attached Control Box, Toggle and Indicator Light (UGAH only): 457-1829 W x 479 D x 64 H mm.
 Dimensions with Remote Control Enclosure (RMB), Toggle and Indicator Light: 457-1829 W x 381 D x 64 H mm.

- OPTIONS – PAGE 60**
- REMOTE CONTROL ENCLOSURES (RMB) – PAGE 64**
- RECOMMENDED MOUNTING HEIGHTS – PAGE 65**

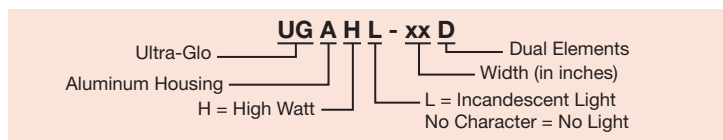

Strip Heaters



UGAH-42D with standard 76 mm spacer. Remote Control Enclosure (RMB) recommended (not shown)

OPTIONS (available at time of purchase only)

Designer colors, aluminum models 457-1829 mm – Clear Anodized Standard – Non-standard colors are non-returnable –

COLOR-6	152 mm Housing for Single UGAH models (color selection below)	per 305 mm	₹1775
COLOR-9	229 mm Housing for Single UGAHL models (color selection below)	per 305 mm	1775
COLOR-15	381 mm Housings for Dual UGAH, UGAL, UGAHL models (color selection below)	per 305 mm	2556
RED	Warm Red	GRAY	Gray Granite
BLACK	Black	WHITE	White Granite
NAVY	Navy Blue	COPPER	Antique Copper
GREEN	Hunter Green		

Gloss Finishes, aluminum models 457-1829 mm – Clear Anodized Standard – Non-standard colors are non-returnable –

GLOSS-6	152 mm Housing for Single UGAH models (finish selection below)	per 305 mm	₹2414
GLOSS-9	229 mm Housing for Single UGAHL models (finish selection below)	per 305 mm	2414
GLOSS-15	381 mm Housings for Dual UGAH, UGAHL (finish selection below)	per 305 mm	3266
RRED	Radiant Red	GGRAY	Glossy Gray
GGOLD	Gleaming Gold	BBLUE	Brilliant Blue
BBLACK	Bold Black		

Designer colors, Remote Control Enclosures – Clear Anodized Standard – Non-standard colors are non-returnable –

RMB-COLOR	Remote Control Housing in <i>Designer</i> color (select color)	₹2556	
RED	Warm Red	GRAY	Gray Granite
BLACK	Black	WHITE	White Granite
NAVY	Navy Blue	COPPER	Antique Copper
GREEN	Hunter Green		

Gloss Finishes, Remote Control Enclosures – Clear Anodized Standard – Non-standard colors are non-returnable –

RMB-GLOSS	Remote Control Housing in Gloss finish (select finish)	₹3692	
RRED	Radiant Red	GGRAY	Glossy Gray
GGOLD	Gleaming Gold	BBLUE	Brilliant Blue
BBLACK	Bold Black		

LIGHTS-ADD'L Extra Lamps – Installed (max. two per 305 mm less one – one per 305 mm is standard) **each ₹ 1775**

UGA-NTL-14, -16 Non-Adjustable Tubular Stands (specify 356 or 406 mm clearance) **pair 6745**

UGA-NTL-18, -20 Non-Adjustable Tubular Stands (specify 457 or 508 mm clearance) **pair 7171**

UGA-NTL-22, -24 Non-Adjustable Tubular Stands (specify 559 or 610 mm clearance) **pair 7739**

UGA-NTL-18-D, -20-D Non-Adjustable Tubular Stands (specify 457 or 508 mm clearance) **2 pair 14342**

UGA-NTL-22-D, -24-D, -26-D Non-Adjustable Tubular Stands (specify 559, 610 or 660 mm clearance) **2 pair 15478**

NTL-PAINT *Designer* color or Gloss finish for Non-Adjustable Tubular Stands – Clear Anodized Standard – Non-standard colors are non-returnable – **pair 2556**

NTL-PAINT-D *Designer* color or Gloss finish for Non-Adjustable Tubular Stands – Clear Anodized Standard – Non-standard colors are non-returnable – **2 pair 5112**

Extended Electrical Leads (Power) – Extend beyond standard 914 mm conduit (must specify lead length) –

HT-LEADS5 305-1524 mm Extended Electrical Leads **₹ 2130**

HT-LEADS10 1829-3048 mm Extended Electrical Leads **4260**

HT-LEADS15 3353-4572 mm Extended Electrical Leads **6390**

HT-LEADS20 4877-6096 mm Extended Electrical Leads **8520**

RMB-UGA Remote Control Enclosure with Toggle Control and Indicator **No Charge**

RMB-UGA-INF Remote Control Enclosure with Toggle Switch, Electronic Infinite Control, Relay, and Indicator Light – *Designer* colors and Gloss finishes available – Clear Anodized Standard – Non-standard colors are non-returnable – **₹23998**

RMB-UGA-INF Remote Control Enclosure with Toggle Switch, Electronic Infinite Control, Relay, and Indicator Light – *Designer* colors and Gloss finishes available – Clear Anodized Standard – Non-standard colors are non-returnable – **₹23998**

RMB-UGA-INF Remote Control Enclosure with Toggle Switch, Electronic Infinite Control, Relay, and Indicator Light – *Designer* colors and Gloss finishes available – Clear Anodized Standard – Non-standard colors are non-returnable – **₹23998**

RMB-UGA-INF Remote Control Enclosure with Toggle Switch, Electronic Infinite Control, Relay, and Indicator Light – *Designer* colors and Gloss finishes available – Clear Anodized Standard – Non-standard colors are non-returnable – **₹23998**

RMB-UGA-INF Remote Control Enclosure with Toggle Switch, Electronic Infinite Control, Relay, and Indicator Light – *Designer* colors and Gloss finishes available – Clear Anodized Standard – Non-standard colors are non-returnable – **₹23998**

RMB-UGA-INF Remote Control Enclosure with Toggle Switch, Electronic Infinite Control, Relay, and Indicator Light – *Designer* colors and Gloss finishes available – Clear Anodized Standard – Non-standard colors are non-returnable – **₹23998**

RMB-UGA-INF Remote Control Enclosure with Toggle Switch, Electronic Infinite Control, Relay, and Indicator Light – *Designer* colors and Gloss finishes available – Clear Anodized Standard – Non-standard colors are non-returnable – **₹23998**

RMB-UGA-INF Remote Control Enclosure with Toggle Switch, Electronic Infinite Control, Relay, and Indicator Light – *Designer* colors and Gloss finishes available – Clear Anodized Standard – Non-standard colors are non-returnable – **₹23998**

RMB-UGA-INF Remote Control Enclosure with Toggle Switch, Electronic Infinite Control, Relay, and Indicator Light – *Designer* colors and Gloss finishes available – Clear Anodized Standard – Non-standard colors are non-returnable – **₹23998**

RMB-UGA-INF Remote Control Enclosure with Toggle Switch, Electronic Infinite Control, Relay, and Indicator Light – *Designer* colors and Gloss finishes available – Clear Anodized Standard – Non-standard colors are non-returnable – **₹23998**

RMB-UGA-INF Remote Control Enclosure with Toggle Switch, Electronic Infinite Control, Relay, and Indicator Light – *Designer* colors and Gloss finishes available – Clear Anodized Standard – Non-standard colors are non-returnable – **₹23998**

RMB-UGA-INF Remote Control Enclosure with Toggle Switch, Electronic Infinite Control, Relay, and Indicator Light – *Designer* colors and Gloss finishes available – Clear Anodized Standard – Non-standard colors are non-returnable – **₹23998**

RMB-UGA-INF Remote Control Enclosure with Toggle Switch, Electronic Infinite Control, Relay, and Indicator Light – *Designer* colors and Gloss finishes available – Clear Anodized Standard – Non-standard colors are non-returnable – **₹23998**

RMB-UGA-INF Remote Control Enclosure with Toggle Switch, Electronic Infinite Control, Relay, and Indicator Light – *Designer* colors and Gloss finishes available – Clear Anodized Standard – Non-standard colors are non-returnable – **₹23998**

RMB-UGA-INF Remote Control Enclosure with Toggle Switch, Electronic Infinite Control, Relay, and Indicator Light – *Designer* colors and Gloss finishes available – Clear Anodized Standard – Non-standard colors are non-returnable – **₹23998**

RMB-UGA-INF Remote Control Enclosure with Toggle Switch, Electronic Infinite Control, Relay, and Indicator Light – *Designer* colors and Gloss finishes available – Clear Anodized Standard – Non-standard colors are non-returnable – **₹23998**

RMB-UGA-INF Remote Control Enclosure with Toggle Switch, Electronic Infinite Control, Relay, and Indicator Light – *Designer* colors and Gloss finishes available – Clear Anodized Standard – Non-standard colors are non-returnable – **₹23998**

RMB-UGA-INF Remote Control Enclosure with Toggle Switch, Electronic Infinite Control, Relay, and Indicator Light – *Designer* colors and Gloss finishes available – Clear Anodized Standard – Non-standard colors are non-returnable – **₹23998**

RMB-UGA-INF Remote Control Enclosure with Toggle Switch, Electronic Infinite Control, Relay, and Indicator Light – *Designer* colors and Gloss finishes available – Clear Anodized Standard – Non-standard colors are non-returnable – **₹23998**

RMB-UGA-INF Remote Control Enclosure with Toggle Switch, Electronic Infinite Control, Relay, and Indicator Light – *Designer* colors and Gloss finishes available – Clear Anodized Standard – Non-standard colors are non-returnable – **₹23998**

COLORS AND FINISHES – INSIDE BACK COVER



RMB-UGA-INF

Glo-Ray® Infra-Black® Strip Heaters

For foodwarming at a close range to food product, the Glo-Ray® Infra-Black® heat technology is ideal, emitting a solid panel of uniform heat. Sturdy continuous single or dual aluminum housings assure quality, durability and a variety of widths, depths, mounting arrangements and colors to fit your operation.

- Provides ideal amount of heat for limited space operations, mounted 102 to 254 mm above target surface for singles and 203 to 356 mm for duals
- Long life metal sheathed heating elements
- Infra-Black emitter provides even heat distribution – eliminating hot spots
- Sturdy aluminum housings that do not sag, from 457 to 1829 mm in 152 mm increments

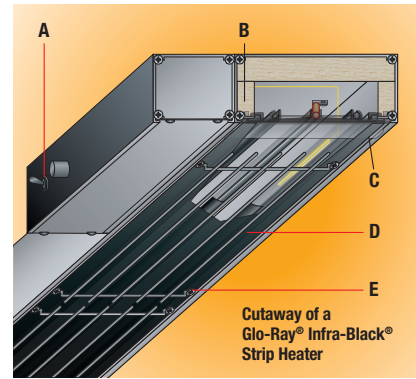

- A** Thermostatically controlled to regulate heat and provide consistent temperature – optional Remote Control Enclosure (RMB) available
- B** Heavy-duty insulation minimizes heat loss
- C** Provides ideal amount of heat for limited space operations, effectively holding product
- D** Optional wire guard available to protect user from incidental contact with the heated surface
- E** Infra-black emitter provides even heat distribution, eliminating hot spots for close applications

GRAIH-36 with optional TCBI Control Box and wire guard



ALUMINUM INFRA-BLACK STRIP HEATERS – HIGH WATT (Must specify and add price of RMB or TCBI)

Model	Width	Voltage Single Phase	Watts	Ship Weight [◇]	List Price [○]
GRAIH-18	457 mm	220	350	5 kg	₹30743 + RMB
GRAIH-24	610 mm	220	500	5 kg	32589 + RMB
GRAIH-30	762 mm	220	660	5 kg	34577 + RMB
GRAIH-36	914 mm	220	800	6 kg	36636 + RMB
GRAIH-42	1067 mm	220	950	7 kg	38908 + RMB
GRAIH-48	1219 mm	220	1100	7 kg	40896 + RMB
GRAIH-54	1372 mm	220	1250	8 kg	42813 + RMB
GRAIH-60	1524 mm	220	1400	9 kg	45866 + RMB
GRAIH-66	1676 mm	220	1560	10 kg	49416 + RMB
GRAIH-72	1829 mm	220	1725	11 kg	56090 + RMB

ALUMINUM DUAL INFRA-BLACK STRIP HEATERS – HIGH WATT (Must specify and add price of RMB or TCBI)

Model	Width	Voltage Single Phase	Watts	Ship Weight [◇]	List Price [○]	
					76 mm Spacer	152 mm Spacer
GRAIH-18D	457 mm	220	700	8 kg	₹ 70645 + RMB	₹ 71355 + RMB
GRAIH-24D	610 mm	220	1000	10 kg	74621 + RMB	75331 + RMB
GRAIH-30D	762 mm	220	1320	10 kg	80656 + RMB	81721 + RMB
GRAIH-36D	914 mm	220	1600	13 kg	86904 + RMB	87969 + RMB
GRAIH-42D	1067 mm	220	1900	16 kg	93223 + RMB	94288 + RMB
GRAIH-48D	1219 mm	220	2200	15 kg	99755 + RMB	101175 + RMB
GRAIH-54D	1372 mm	220	2500	19 kg	106216 + RMB	107636 + RMB
GRAIH-60D	1524 mm	220	2800	21 kg	114949 + RMB	117079 + RMB
GRAIH-66D	1676 mm	220	3120	20 kg	124747 + RMB	126877 + RMB
GRAIH-72D	1829 mm	220	3450	23 kg	139444 + RMB	141574 + RMB

○ Does not include Remote Control Enclosure (RMB) or Thermostatic Control Box (TCBI). Must choose either RMB (see page 64) or TCBI see Options on page 62).
 ◇ Does not include RMB.

All Infra-Black Models Feature:

Leads: 152 mm pigtail leads – server's right.

Dimensions: GRAIH: 457-1829 W x 152 D x 64 H mm.

GRAIH-xxD with 76 mm Spacer: 457-1829 W x 381 D x 64 H mm.

GRAIH-xxD with 152 mm Spacer: 457-1829 W x 457 D x 64 H mm.

Control Enclosure Dimensions (not including switches): 203 W x 76 D x 64 H mm.

Control Enclosure Location: Chef's left side (unless otherwise specified).

OPTIONS AND ACCESSORIES – PAGE 62

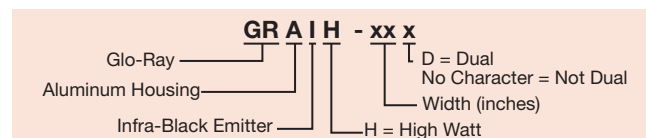

Strip Heaters



GRAIH-72 requires Remote Control Enclosure (RMB)

OPTIONS (available at time of purchase only)

Designer colors, aluminum models 457-1829 mm – Clear Anodized Standard – Non-standard colors are non-returnable –

COLOR-6	152 mm Housing for GRAIH models (color selection below)					per 305 mm	₹1775
COLOR-15, -18	381 mm and 457 mm Housings for GRAIH Dual models (color selection below)					per 305 mm	2556
RED	Warm Red	GRAY	Gray Granite	NAVY	Navy Blue	COPPER	Antique Copper
BLACK	Black	WHITE	White Granite	GREEN	Hunter Green		

Gloss finishes, aluminum models 457-1829 mm – Clear Anodized Standard – Non-standard colors are non-returnable –

GLOSS-6	152 mm Housing for GRAIH models (finish selection below)					per 305 mm	₹2414
GLOSS-15, -18	381 mm and 457 mm Housings for GRAIH Dual models (finish selection below)					per 305 mm	3266
RRRED	Radiant Red	GGRAY	Glossy Gray	BBLACK	Bold Black		
GGGOLD	Gleaming Gold	BBLUE	Brilliant Blue				

TCBI	Thermostatic Control Box with Indicator Lights	12212
-------------	--	-------

Remote Control Enclosure – Available in Designer colors and Gloss finishes – Clear Anodized Standard – Non-standard colors are non-returnable –

AIH18WG -AIH72WG	Element Wire Guard (Dual models require two sets)	See page 64 for models and prices	per 305 mm (per side)	₹ 1846
AIH4NTL	102 mm Non-Adjustable Tubular Stands		pair	6319
AIH6NTL	152 mm Non-Adjustable Tubular Stands		pair	6319
AIH8NTL	203 mm Non-Adjustable Tubular Stands (Dual models require two pair)		pair	6319
AIH10NTL	254 mm Non-Adjustable Tubular Stands (Dual models require two pair)		pair	6319
AIH12NTL-D	305 mm Non-Adjustable Tubular Stands		2 pair	12638
AIH14NTL-D	356 mm Non-Adjustable Tubular Stands		2 pair	13490
NTL-PAINT	Designer color or Gloss finish for Non-Adjustable Tubular Stands – Clear Anodized Standard – Non-standard colors are non-returnable –		pair	2556
NTL-PAINT-D	Designer color or Gloss finish for Non-Adjustable Tubular Stands – Clear Anodized Standard – Non-standard colors are non-returnable –		2 pair	5112

Extended Electrical Leads (Power) – Extend beyond standard 152 mm pigtail leads (must specify lead length) –

HT-LEADS5	305-1524 mm Extended Electrical Leads	₹2130
HT-LEADS10	1829-3048 mm Extended Electrical Leads	4260
HT-LEADS15	3353-4572 mm Extended Electrical Leads	6390
HT-LEADS20	4877-6096 mm Extended Electrical Leads	8520

ACCESSORIES – see page 63 for illustrations

ADJ ANGLE	60 mm Adjustable Angle Brackets for Single models	pair	₹1704
ADJ ANGLE7	178 mm tall Adjustable Angle Bracket for Single models	pair	1917
ADJ ANGLE-D	60 mm Adjustable Angle Brackets for Dual models	2 pair	3408
ADJ ANGLE7-D	178 mm tall Adjustable Angle Brackets for Dual models	2 pair	3834
CHAIN 1	Chain Suspension	per 305 mm	639

COLORS AND FINISHES – INSIDE BACK COVER

Glo-Ray® Mounting Arrangements

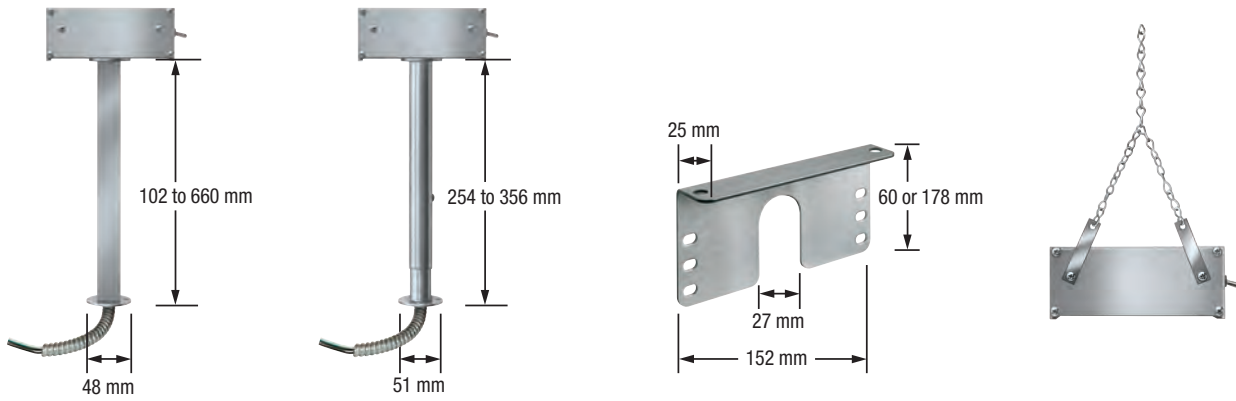

PERMANENT - FOR HARD WIRED INSTALLATION

Non-Adjustable Tubular Stands (NTL)

Sturdy stands conceal all supply wiring. Available in *Designer* colors. Duals require two pair. Specify bottom power location.

Adjustable Tubular Stands (ATL)

Sturdy tubular stands conceal all supply wiring. Duals require two pair. Specify bottom power location (not available on Ultra-Glo® models).

Angle Brackets (ANGLE)

Special adjustable angle brackets fit 152 or 229 mm housings for mounting Glo-Ray under a shelf. 60 mm Adjustable Angle Bracket provides 25-51 mm space while the 70 mm Adjustable Angle Bracket provides 25 - 152 mm space between Glo-Ray and overself. Duals require two pair (standard on Ultra-Glo models).

Chain Suspension (CHAIN)

Chains attach to tabs provided with warmers and are available in various lengths to suit the location (not available on Ultra-Glo models).

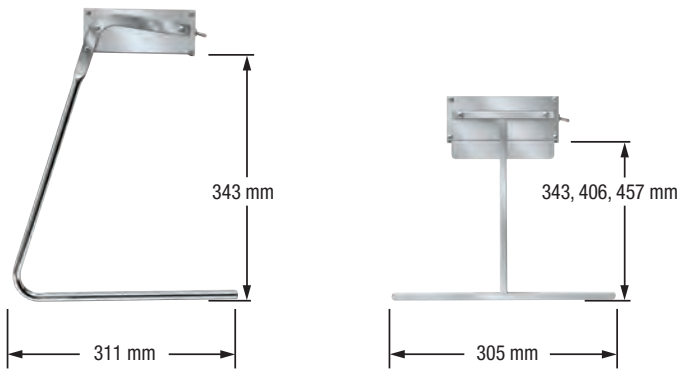

PORTABLE - FOR CORD AND PLUG INSTALLATION

C-Leg Stands (CL)

Attractive plated legs allow easy relocation of the warmer. For models 1829 mm or less in width (not available on Ultra-Glo models).

T-Leg Stands (TL)

Provide rigid stability and allow for more pass-through area below unit. For models 1829 mm or less in width (not available on Ultra-Glo models).

Strip Heaters

Remote Control Enclosures (RMB)

Hatco Remote Control Enclosures (RMB) are built with toggle or infinite switches, indicator lights and wiring, ready for installation when purchased with Glo-Ray® Strip Heaters.

- Built for toggle or infinite switches, indicator lights and wiring
- Threaded rubber boot for toggle switch is Standard
- One RMB per Strip Heater (except RMB2 units)



RMB-14
with infinite
controls



RMB-3 with
toggle switch and
indicator light



RMB-7 with toggle switch
and infinite control



RMB-7 with toggle switches
and optional *Designer Color*

REMOTE CONTROL ENCLOSURES (RMB)

Model	Description	Width	List Price
RMB-3	1 toggle switch	140 mm	₹ 9372
	2 toggle switches	140 mm	10650
RMB-7	1 toggle switch, 1 indicator light	140 mm	10650
	1 infinite switch	140 mm	10650
	3 toggle switches	229 mm	₹13135
	4 toggle switches	229 mm	15407
RMB-14	2 toggle switches, 2 indicator lights	229 mm	14129
	1 toggle switch, 1 infinite switch	229 mm	12993
	1 toggle switch, 1 infinite switch 1 indicator light	229 mm	14342
	2 infinite switches	229 mm	14342
	1 infinite switch, 1 indicator light	229 mm	12780
	4 toggle switches	356 mm	-
	5 toggle switches	356 mm	₹19454
	6 toggle switches	356 mm	22933
RMB2-1R	3 toggle switches, 3 indicator lights	356 mm	-
	2 toggle switches, 2 infinite switches	356 mm	20164
	1 toggle switch, 2 infinite switches	356 mm	17608
	4 infinite switches	356 mm	22649
	2 infinite switches, 2 indicator lights	356 mm	18176
	4 infinite switches, 1 toggle switch	406 mm	22649
RMB2-1R	1 toggle, 1 infinite, 1 relay, 1 indicator	280 mm	₹48564

Toggle Switch: Max. 15 Amps
Infinite Switch: Max. 12.2 Amps

Remote Control Enclosures (RMB):
When used, no more than one RMB per Strip heater and no more than one Strip Heater per RMB (except RMB2 units).

"Choose Remote Box" (RMB) can be found on:
www.hatcocorp.com
under "Resources"

All Models Feature:

Voltage: 220.

Ship Weight: 1-3 kg depending on components.

Max. Allowable Amperage per Switch: **Toggle:** 15.0

Infinite: 12.2

RMB2-1R: 16 or 20

Dimensions (not including switches): 140, 229, 356 or 406 W x 76 D x 64 H mm.

RMB2-1R: 280 W x 115 D x 140 H mm.

RMB2-1R Cutout Dimensions: 258 W x 121 H mm.

OPTIONS (available at time of purchase only)

Designer Colors (not available for RMB2-1R) – Clear Anodized Standard – Non-standard colors are non-returnable –

RMB-COLOR	Remote Control Enclosure Housing in <i>Designer Color</i>					₹2556	
RED	Warm Red	GRAY	Gray Granite	NAVY	Navy Blue	COPPER	Antique Copper
BLACK	Black	WHITE	White Granite	GREEN	Hunter Green		

Gloss Finishes (not available for RMB2-1R) – Clear Anodized Standard – Non-standard colors are non-returnable –

RMB-GLOSS	Remote Control Enclosure Housing in Gloss Finish			₹3692	
RRED	Radiant Red	GGRAY	Glossy Gray	BBLACK	Bold Black
GGOLD	Gleaming Gold	BBLUE	Brilliant Blue		

COLORS AND FINISHES – INSIDE BACK COVER

Strip Heater Recommended Range Above Target* and Spacing Requirements (Based on 610 mm Foodwarmer)

Glo-Ray® Infrared Heating Element (Recommended range above target)

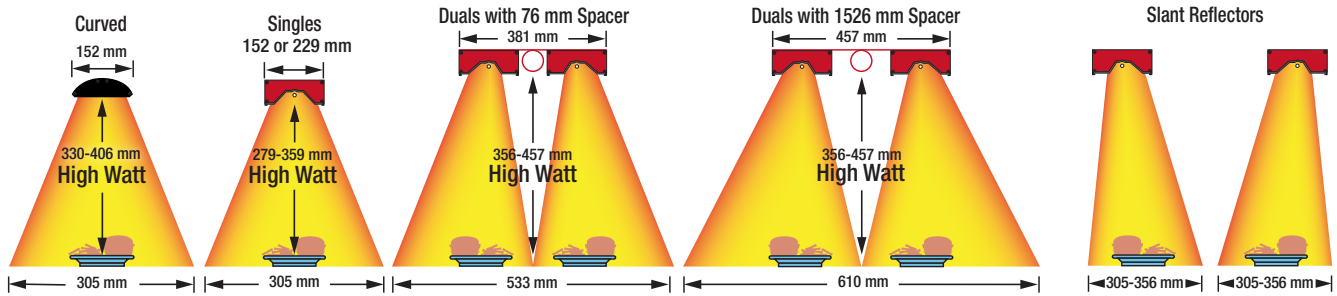

GLO-RAY® INFRARED HEATING ELEMENT

Curved High Watt (GM5AH, GM5AHL)

Non-combustible surroundings only. Install 25 mm from overshelf and minimum of 254 mm above a non-combustible countertop surface (back of wall: no requirement).

Singles (GRH, GRAH, GRAHL) –

Combustibles: 343 mm below, 25 mm above and 76 mm to back wall. Non-combustibles: 25 mm above, 254 mm below with infinite or indicator lamp and 203 mm below toggle. Must be installed in a pass-through area. Units with remote switches may be installed against a non-combustible back wall, flush to an overshelf and 203 mm to a surface below. Maximum 254 mm setback from the front of an overshelf. Models with cords must be installed 76 mm below an overshelf and 297 mm over a surface below.

Duals (GRAH-D, GRAHL-D) –

May not be installed in combustible surroundings. Non-combustibles: 25 mm above, 254 mm below. Must be installed in a pass-through area. Units with remote switches may be installed 76 mm from a non-combustible back wall, 203 mm to surface below and flush to an overshelf. Maximum 254 mm setback from the front of an overshelf.

Slant Reflectors: Optional slant reflectors are available to direct the heat pattern front or back.

Ultra-Glo® Heating Element (Recommended range above target)

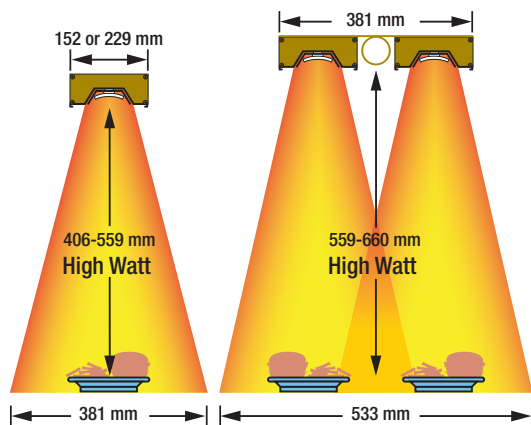

ULTRA-GLO®

Singles and Duals: (UGAH, UGAHL, UGAH-D, UGAHL-D) – May not be installed in combustible surroundings. Non-combustibles: 25 mm above, 432 mm from a surface below and 76 mm from a back wall.

Dual Mounting: Do not mount warmers side by side (dual mounting) with less than a 76 mm space between units.

Infra-Black® Heating Element (Recommended range above target)

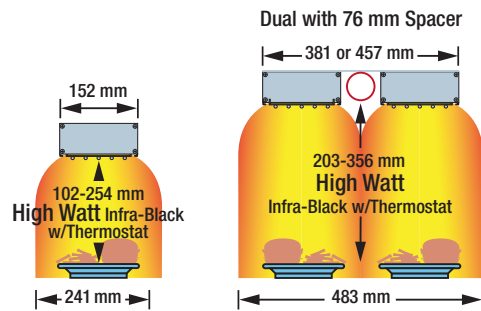

GLO-RAY® INFRA-BLACK®

(GRAIH, GRAIH-D) –

May not be installed in combustible surroundings. Non-combustibles: 25 mm above and 102 mm below. Must be installed in a pass-through area. Units with remote switches may be installed 76 mm from a non-combustible back wall and flush to an overshelf. Maximum 254 mm setback from the front of an overshelf.

Remote Control Enclosures: When used, no more than one RMB per strip heater and no more than one strip heater per RMB.

DEPTH OF HEAT PATTERN AT RECOMMENDED ELEMENT HEIGHT

* Recommended single unit application without base heat, based on ideal conditions. Individual applications may vary, consult factory.

Fry Stations

Supermarkets & Delis
Restaurants & Cafés • Clubs & Bars



GRFFL with optional 229 mm display sign holder (sign not included), *Designer Warm Red* color and accessory food pan *pg. 67*



GRFF in optional *Brilliant Blue* and **UGFF** in optional *Glossy Gray* finish *pg. 67*



GRFHS-PT26 with accessory fry box ribbon *pg. 69*



GRFHS-PT26 with accessory 8-pleat hardcoated fry box ribbon (scoop not included) *pg. 69*



GRFHS-PTT21 *pg. 69*



GRFSCL-18 with swing-away post mount, cord with plug and accessory food pan *pg. 69*

Portable Foodwarmers

Opt for the versatility of Hatco's Glo-Max®, Glo-Ray® and Ultra-Glo® Portable Foodwarmers. With heat from above, below or both, these foodwarmers offer design flexibility without sacrificing food product quality. Ideal for use next to fry stations, drive-through windows and service areas that require frequent and easy access.

- Portable – ready to plug in and use
- Versatile – available in many sizes, styles and heat sources to fit your needs
- Flexible – both top and bottom heat available
- Available with incandescent bulbs containing special protective coating to guard against food contamination
- Toggle switch is standard; infinite switch optional on GRFF series
- All base heat units (GR-B, GRFFB and UGFFB) have a preset automatic thermostat to maintain consistent temperatures
- GMFFL, GRFF, GRFFL, UGFF, UGFFL provide top heat only
- Ceramic heating elements provide more distance between the heat source and the holding pan (UGFF series only)



GR-B Heated Base with accessory sheet pan

GRFFB with optional infinite switch and accessory food pans



GMFFL in standard Designer Black and accessory food pan



GLO-MAX® PORTABLE FOODWARMER WITH METAL SHEATHED ELEMENTS

Model	Dimensions (W x D x H)	Voltage (Single Phase)	Watts	Ship Weight	List Price
GMFFL	329 x 644 x 445 mm	230	610	10 kg	₹22720

All Metal Sheathed Models Feature:

Model Shipped with: 1829 mm cord and plug, base front sign holder, and clear plastic insert for sign holder.

Cord Location: Back, upper middle.

GLO-RAY® PORTABLE FOODWARMERS WITH METAL SHEATHED ELEMENTS

Model	Dimensions (W x D x H)	Voltage (Single Phase)	Watts	Ship Weight	List Price
GR-B	324 x 559 x 57 mm	220	210	7 kg	₹36991
GRFF	314 x 610 x 400 mm	220	500	7 kg	37630
GRFFL	314 x 610 x 400 mm	220	600	7 kg	48138
GRFFB♦	324 x 610 x 406-508 mm	220	710	13 kg	59640
GRFFBL♦	324 x 610 x 406-508 mm	220	810	14 kg	70503

♦ Standard clearance is 356 mm. Specify 306 or 406 mm if required.

All Metal Sheathed Models Feature:

Models Shipped with: 1829 mm cord and plug.

Cord Location: GR-B, GRFFB, GRFFBL: Back, lower middle.

GRFF, GRFFL: Back, upper middle.

OPTIONS AND ACCESSORIES – PAGE 68

ULTRA-GLO® PORTABLE FOODWARMERS WITH CERAMIC ELEMENTS

Model	Dimensions (W x D x H)	Voltage (Single Phase)	Watts	Ship Weight	List Price
UGFF	314 x 565 x 479 mm	220	630	7 kg	₹46860
UGFFL	314 x 565 x 479 mm	220	730	8 kg	57723
UGFFB	324 x 572 x 559 mm	220	840	12 kg	70290
UGFFBL	324 x 572 x 559 mm	220	940	16 kg	81295

All Ceramic Portable Models Feature:

Models Shipped with: 1829 mm cord and plug.

Cord Location: UGFF, UGFFL: Back, upper middle.

UGFFB, UGFFBL: Back, lower middle.

OPTIONS AND ACCESSORIES – PAGE 68



Fry Stations



UGFFB with accessory food pan (perforated pan not available)

OPTIONS (available at time of purchase only) (excludes GMFFL)

Designer Colors (one color per unit, heated base is not painted, excludes GR-B models)

Non-standard colors are non-returnable – Clear Anodized standard –

RED	Warm Red	₹8378
BLACK	Black	8378
GRAY	Gray Granite	8378
WHITE	White Granite	8378
NAVY	Navy Blue	8378
GREEN	Hunter Green	8378
COPPER	Antique Copper	8378

Gloss Finishes (one color per unit, heated base is not painted, excludes GR-B models)

Non-standard colors are non-returnable –

RRED	Radiant Red	₹11644
GGOLD	Gleaming Gold	11644
GGRAY	Glossy Gray	11644
BBLUE	Brilliant Blue	11644
BBLACK	Bold Black	12354

Clearance – from bottom of Glo-Ray to top of heated surface (GRFFB, GRFFBL only) –

305 mm	No Charge
356 mm	Standard
406 mm	No Charge

SIGN HOLD	Sign Holder for GRFFL model with Back Toggle only (Requires 229 W x 140 H x 2 D mm sign, not included) Adds 76 mm to height of unit	₹2627
INF	Infinite Control (not available on models GR-B, GMFFL, UGFF, UGFFL, UGFFB or UGFFBL)	2627

ACCESSORIES

5PLTBOX	Five-Pleat Hardcoated French Fry Box Ribbon – 489 W x 235 D x 51 H mm	₹12780
8PLTBAG	Eight-Pleat Hardcoated French Fry Bag Ribbon – 489 W x 235 D x 51 H mm	12780
<i>Chef LED 230V adjustable bulb – excludes GR-B and GMFFL – see page 49 for more information</i>		
CLED-2700-230	Chef LED Bulb (similar to warm Incandescent light)	₹7171
CLED-3000-230	Chef LED Bulb (similar to warm Halogen light)	7171
CLED-4000-230	Chef LED Bulb (similar to cool Fluorescent light)	7171

FRY RIBBONS – PAGE 70
FOOD PANS AND TRIVETS – PAGE 143
COLORS AND FINISHES – INSIDE BACK COVER



Accessory Chef LED Bulb

Glo-Ray® Fry Stations

Hatco offers convenient Glo-Ray® Fry Stations that can be placed where they are most needed – next to a fryer! Glo-Ray heat technology offers the ability to keep fried foods at optimum temperatures, ready to serve, without cooking or drying them out.

- Various hardcoated fry ribbons stage boxed or bagged products for quick-service areas
- Thermostatically-controlled heated base maintains uniform holding temperatures from below (GRFHS series)
- Portable models including pass-through style (GRFHS series)
- Ceramic elements and slotted holding bin prevent soggy product (GRFHS series)
- Accessory hardcoated fry ribbons absorb more radiant heat than stainless steel and can be up to 8° to 11°C hotter (GRFHS series)
- Sectional divider permits holding of multiple products simultaneously (GRFHS series)
- Built-in top heat source features a swing-away post mount (GRFSC, GRFS series)
- Fry Station Warmers (GRFSC, GRFS series) feature a built-in top heat source and a swing-away post mount
- A variety of clearances are offered (GRFS series)
- Power toggle switch and cord and plug are available (GRFS series)
- Optional infinite control offered (GRFS series)

GRFHS-21 with optional right-hand cutout for fry basket and accessory fry ribbon (left-hand cutout also available)



GRFHS-16



GRFHS-PTT21



GRFSC-18
Swing-away post mount

PORTABLE FRY HOLDING STATIONS

Model	Bulbs	Dimensions W x D x H	Voltage Single Phase	Watts	Ship Weight	List Price
GRFHS-16*	2	416 x 559 x 564 mm	220	1057	24 kg	₹189215
GRFHS-21*	2	543 x 724 x 578 mm	220	1218	29 kg	207888
GRFHS-26*	2	672 x 595 x 578 mm	220	1243	30 kg	213497
GRFHS-PT26[▲]	2	759 x 570 x 625 mm	220	1233	29 kg	213497
GRFHS-PT26^{▲■}	2	759 x 570 x 625 mm	220	1233	29 kg	221023
GRFHS-PTT21*	2	578 x 965 x 630 mm	220	1486	46 kg	217047

■ Includes a built-in 152 mm deep heated food holding base (102 mm is standard on all other models).

▲ Scoop Holder standard.

* Subtract 52 mm from width if ordering without Scoop Holder.

All Fry Holding Station Models Feature:

Models Shipped with: One slotted holding bin and one sectional divider.

Cord Location: GRFHS-16, -21, -26, -PT26: Back side, lower right corner.

GRFHS-PTT21: Lower right-hand side.

FRY STATION WARMERS

Model	Bulbs	Dimensions W x D x H	Voltage Single Phase	Watts	Ship Weight	List Price
GRFSC-18[□]	–	152 x 457 x 489-572 mm	220	630	5 kg	₹40967
GRFSC-18[□]	2	229 x 457 x 489-572 mm	220	730	6 kg	49132
GRFSCR-18[†]	–	152 x 457 x 489-572 mm	220	630	5 kg	40967
GRFSC-18^{□†}	2	229 x 457 x 489-572 mm	220	730	6 kg	49132
GRFS-24[□]	–	152 x 610 x 318-394 mm	220	500	5 kg	33441
GRFSL-24[□]	2	229 x 610 x 318-394 mm	220	600	6 kg	42174
GRFSR-24^{□†}	–	152 x 610 x 318-394 mm	220	500	5 kg	33441
GRFSLR-24^{□†}	2	229 x 610 x 318-394 mm	220	600	6 kg	42174

□ Specify clearance of 305, 425, 457 (standard) or 508 mm when ordering.

† Fry Station Warmer without cord and plug. Supply wires through mounting post.

□ Specify clearance of 254, 279, 305 or 330 mm (standard) when ordering.

All Fry Station Warmer Models Feature:

Toggle Switch Location: Ceramic Heating Element Models: Back of unit.

Metal Sheathed Heating Element Models: Front of unit.

Cord Location GRFS-24 and GRFSL-24: Back, upper middle.

OPTIONS AND ACCESSORIES – PAGE 70

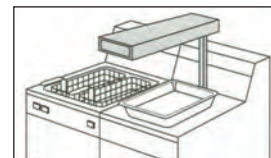
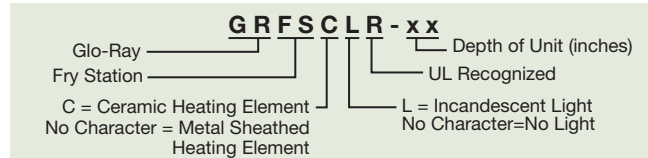
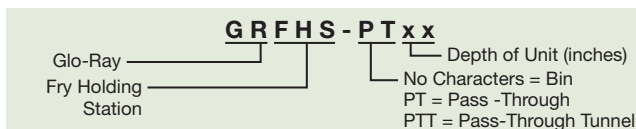

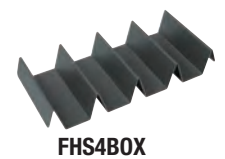
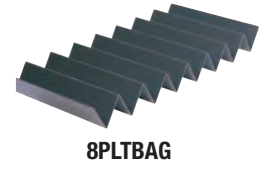
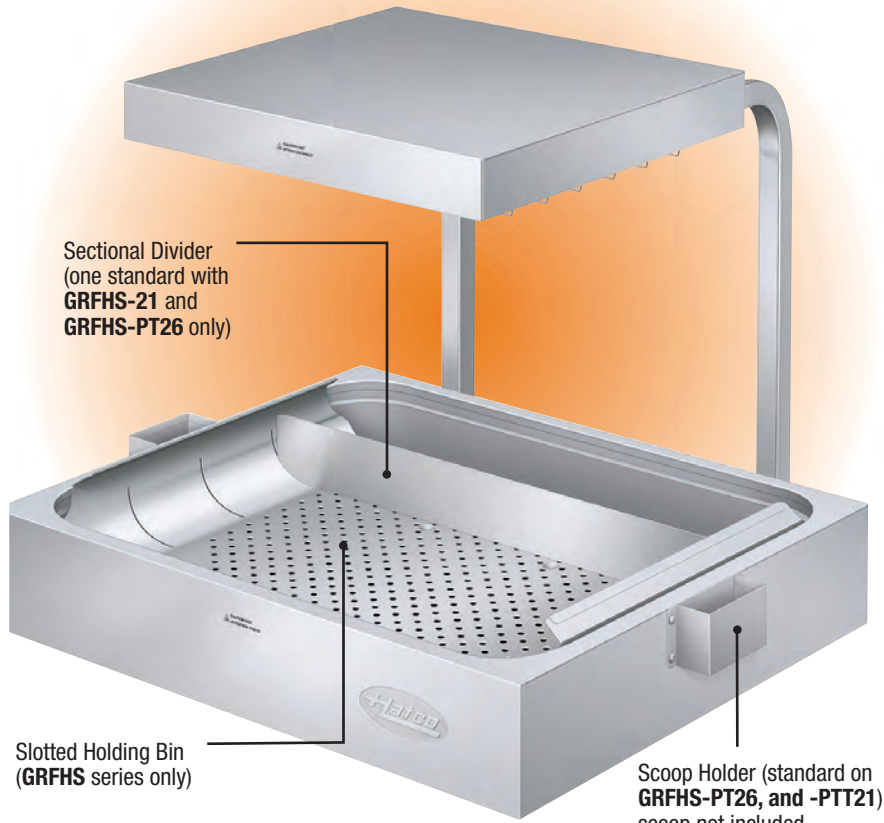

OPTIONS (available at time of purchase only)

FHS-CUT	Right- or Left-Hand Cutout for Fry Basket (must specify side at time of order) Adds 43 mm to width of unit (GRFHS-16, -21, -26 models only)	No Charge
INF	Infinite Control (metal sheathed GRFS models only)	₹2627

ACCESSORIES

5PLTBOX	Five-Pleat Hardcoated French Fry Box Ribbon – 489 W x 235 D x 51 H mm	₹12780
8PLTBAG	Eight-Pleat Hardcoated French Fry Bag Ribbon – 489 W x 235 D x 51 H mm	12780
FHS4BOX	Four-Pleat Hardcoated Fry Box Ribbon (GRFHS-16 & -26) – 273 W x 127 D x 44 H mm	4899
FHS5BAG	Five-Pleat Hardcoated Fry Bag Ribbon (GRFHS-16 & -26) – 286 W x 127 D x 48 H mm	4899
FHS5BOX	Five-Pleat Hardcoated Fry Box Ribbon (GRFHS-21) – 445 W x 127 D x 48 H mm	7952
FHS7BAG	Seven-Pleat Hardcoated Fry Bag Ribbon (GRFHS-21) – 454 W x 127 D x 48 H mm	7952
PT26-10BAG	Ten-Pleat Hardcoated Fry Bag Ribbon (GRFHS-PT26) – 572 W x 127 D x 48 H mm	9869
5BH	127 mm Side-by-Side Bag Holder (GRFHS-21)	3266
FHS-SH	Scoop Holder (adds 32 mm to width of unit) – one standard on GRFHS-PT26, -PTT21 models	3266
FHSDIV1	Sectional Dividers – 407 W x 83 H mm (GRFHS-16, -26 models)	1917

Chef LED 230V adjustable bulb – see page 49 for more information

CLED-2700-230	Chef LED Bulb (similar to warm Incandescent light)	₹7171
CLED-3000-230	Chef LED Bulb (similar to warm Halogen light)	7171
CLED-4000-230	Chef LED Bulb (similar to cool Fluorescent light)	7171

FOOD PANS AND TRIVETS – PAGE 143



Accessory Chef LED Bulb

Carving Stations

*Supermarkets & Delis
Restaurants & Cafés • Clubs & Bars*



DCSB400-1CM models above **HGSM-4060** models *pg. 72*



DCSB400-R24-1 with optional Bermuda Sand Base and optional Bright Brass post and shade *pg. 72*



DCSB400-R24-1 with optional Gray Granite Base and standard Bright Nickel post and shade. Shown with **GR2S-36** *pg. 72*



DCSB400-R24-1 with optional Gray Granite base and standard Bright Nickel post and shade *pg. 72*



GRCsCL-24 with accessory left-hand sneeze guard, drip pan and cutting board *pg. 73*



ACCESSORIES (CSCL-BOARD shown) *pg. 73*

Decorative Carving Station

Providing proper food serving temperatures, the Decorative Carving Station combines the Hatco Decorative Heat Lamp with a simulated stone heated base to create an attractive carving display. These warmers are perfect for chef stations in restaurants, hotels, country clubs, casinos and any catered event.

- Available as post mount, permanent counter mount or freestanding with a rounded or rectangular heated simulated stone base (DCS400-1, -1CM do not have bases)
- The patented telescoping heated decorative lamp has a 30° shade pivot
- Decorative posts and shades are available in five Plated finishes – non-standard colors are non-returnable
- Heated bases are made of foodsafe materials and come in three simulated stone colors – non-standard colors are non-returnable
- Heated base is controlled by an adjustable thermostat and power switch
- Units come with matching cutting board (excludes DCS400-1, -1CM), keeping juices contained and tablecloths clean
- DCS400-1 has a 10 kg weighted base, perfect for buffet use
- Sneeze guard is removable for easy cleaning (DCSB400-R24-1, -2420-1, -3624-2 models only)
- Models with simulated stone are made of Swanstone®

DCS400-1CM
with optional Bright Brass post and shade
optional Bermuda Sand trim ring



DCSB400-R24-1
with optional Bermuda Sand base and standard Bright Nickel post and shade



DCSB400-3624-2
with standard Night Sky base and standard Bright Nickel posts and shades



DECORATIVE CARVING STATIONS

Model	No. of Lamps	Width	Heated Base Surface Area	Voltage Single Phase	Watts	Ship Weight	List Price
DCS400-1	1	203 mm	–	220-240	210-250	15 kg	₹101175
DCS400-1CM	1	156 mm	–	220-240	210-250	9 kg	99045
DCSB400-R24-1	1	660 mm	610 mm dia.	220-240	530-631	34 kg	247080
DCSB400-2420-1	1	610 mm	610 W x 508 D mm	220-240	667-794	38 kg	247080
DCSB400-3624-2	2	914 mm	914 W x 610 D mm	220-240	1152-1371	60 kg	359260

All Decorative Carving Station Models Feature:

- Models Shipped with: DCS400-1, -1CM One clear coated bulb. DCS400-1 includes black base.
 DCSB400-R24-1, -2420-1: One clear coated bulb, base heat, glass sneeze guard and cutting board.
 DCSB400-3624-2: Two clear coated bulbs, base heat, glass sneeze guard and cutting board.
 Telescoping Clearance: DCS400-1, -1CM: (bottom of shade to counter) 406 - 711 mm.
 DCSB400-R24-1, -2420-1, -3624-2: (bottom of shade to top of cutting board) 356 - 660 mm.
 Cord Location: DCS400-1: Base of unit, server side center. DCS400-1CM: Under counter.
 DCSB400-R24-1: Base of unit, server side on left.
 DCSB400-2420-1: Base of unit, server side on left.
 DCSB400-3624-2: Base of unit, server side on left.

DCS400-1
with optional Bright Brass post and shade and black base



OPTIONS (available at time of purchase only)

Shade and post(s) in Plated finish, no additional charge – Non-standard colors are non-returnable – Bright Nickel Standard –

BBRASS	Bright Brass	No Charge
BCOPPER	Bright Copper	No Charge
ABRASS	Antique Brass	No Charge
ABRONZE	Antique Bronze	No Charge



Close-up of Trim Ring in Standard Night Sky (in Optional Plated Antique Bronze finish)

Base and Cutting Board in simulated stone (except DCS400-1, -1CM), no additional charge – Non-standard colors are non-returnable – Night Sky Standard –

GGRAN	Gray Granite	No Charge
BSAND	Bermuda Sand	No Charge

Trim Ring (DCS400-1CM only) in simulated stone, no additional charge – Non-standard colors are non-returnable – Night Sky Standard –

GGRAN	Gray Granite	No Charge
BSAND	Bermuda Sand	No Charge

DCSBxxx-xxxx-xCM

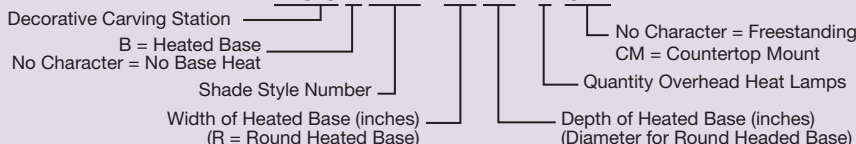

Glo-Ray® Carving Stations

An excellent addition to extend food holding times during serving periods is the Glo-Ray® Carving Station. Create a complete serving station for buffets by adding it to Hatco's Flav-R-Savor® Holding Cabinet.

- Overhead ceramic heating elements project high intensity radiant heat over entire target area
- Adjustable clearance of 445 to 570 mm
- Portable – includes a 1829 mm cord and plug
- Shatter-resistant incandescent lights illuminate holding area
- Drip pan and cutting board available
- GRCSCLH has base heat



GRCSCL-24 with accessory left-hand sneeze guard, drip pan and cutting board



GRCSCLH-24 with accessory left-hand sneeze guard, drip pan and cutting board



GRCSCLH-24 controls

CARVING STATIONS WITH CERAMIC ELEMENTS

Model	Dimensions W* x D x H	Voltage Single Phase	Watts	Ship Weight	List Price
GRCSCL-24	660 x 711 x 572-724 mm	220	1137	25 kg	₹230963
GRCSCLH-24	660 x 711 x 572-724 mm	220	1438	25 kg	260570

* Width includes accessory left-hand sneeze guard.

All Carving Station Models Feature:

Models Shipped with: Right-hand sneeze guard.

Cord Location: Back side on base.

ACCESSORIES

CSCLB/PACC	Left-Hand Sneeze Guard Kit (1 kg)	₹16756
CSCL-PAN	Stainless Steel Custom Drip Pan 508 x 679 x 25 mm (4 kg)	17182
CSCL-BOARD	NSF Approved Cutting Board – 457 x 610 x 44 mm (9 kg)	16259
Chef LED 230V adjustable bulb – see page 49 for more information		
CLED-2700-230	Chef LED Bulb (similar to warm Incandescent light)	₹7171
CLED-3000-230	Chef LED Bulb (similar to warm Halogen light)	7171
CLED-4000-230	Chef LED Bulb (similar to cool Fluorescent light)	7171



CSCLB/PACC

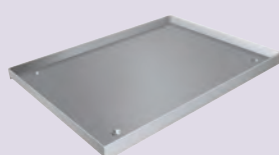

CSCL-PAN



CSCL-BOARD



Accessory Chef LED Bulb

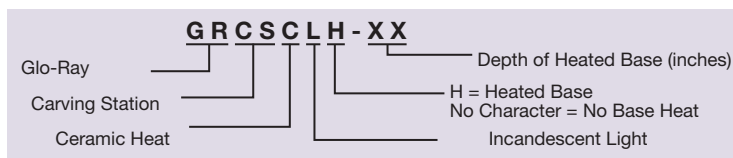

Portables

*Cafeterias • Buffets • Convenience Stores
Supermarkets & Delis • Restaurants & Cafés
Clubs & Bars • Catering • Concessions*



GRSR-17 with optional *Designer Navy Blue* color and accessory food pan *pg. 75*



GRSSR with optional 76 or 127 mm risers *pg. 76*



GRSSR20-DL77516 with standard *Night Sky* simulated stone heated base *pg. 76*



GRSS-3618 in optional *Bermuda Sand* simulated stone *pg. 78*



HBG-2418 in optional *white ceramic glass* *pg. 79*



HGSM-4060 *pg. 80*



GRS-72-I with accessory food pans *pg. 81*



GRHW-1SG *pg. 83*



GRBW-30 with optional enclosures *pg. 84*

Portable Round Heated Shelves

The contemporary-styled Round Heated Shelf keeps hot food at serving temperatures. Ideal when used for wrapped product or for use behind a sneeze guard with unwrapped food like pizza, biscuits, muffins and cookies.

- Unit is designed for countertop or built-in use – see cutout dimensions below
- Uniform heat distribution with blanket-type element
- Thermostatically-controlled heated base
- Available in three sizes to hold standard 381, 432 or 483 mm diameter pans
- Lighted power switch with cord and plug attached
- Optional stainless steel trim



GRSR-17 with optional Navy Blue *Designer* color and accessory food pan



GRSR-19 with optional Hunter Green *Designer* color and accessory pizza pan

PORTABLE ROUND HEATED SHELVES

Model*	Dimensions Dia. x H	Voltage Single Phase	Watts	Ship Weight	List Price
GRSR-15	425 x 98 mm	220	210	8 kg	₹57368
GRSR-17	476 x 98 mm	220	273	9 kg	60421
GRSR-19	527 x 98 mm	220	336	10 kg	63829

* When no color is specified, unit will be black.

All Round Heated Shelf Models Feature:

Maximum Pan Size: GRSR-15 = 381 mm diameter
 GRSR-17 = 432 mm diameter
 GRSR-19 = 483 mm diameter

Cord Location: Underneath.

PORTABLE ROUND HEATED SHELVES COUNTERTOP CUTOUT DIMENSIONS (For Built-In Applications)

Model	Minimum Diameter	Maximum Diameter	Below Counter
GRSR-15	410 mm	413 mm	137 mm
GRSR-17	460 mm	464 mm	137 mm
GRSR-19	511 mm	514 mm	137 mm

FOOD PANS AND TRIVETS – PAGE 143

OPTIONS (available at time of purchase only)

SS SIDE	Stainless Steel Side	No Charge
Designer colors – Non-standard colors are non-returnable – Black Standard –		
RED	Warm Red	No Charge
GRAY	Gray Granite	No Charge
WHITE	White Granite	No Charge
NAVY	Navy Blue	No Charge
GREEN	Hunter Green	No Charge
COPPER	Antique Copper	No Charge

COLORS AND FINISHES – INSIDE BACK COVER



Glo-Ray® Portable Round Heated Simulated Stone Shelves

Hatco's Glo-Ray® Portable Heated Simulated Stone Shelves are made of foodsafe materials and come in three simulated stone colors. These unique warmers will safely hold food hot while blending in with your décor and are ideal for buffet lines or as hors d'oeuvre displays.

- Hatco Heated Simulated Stone Shelves are made of approved foodsafe materials
- Features a lighted rocker switch, cord & plug and thermostatically-controlled heat base to help hold your food hot and delicious
- Optional 76 or 127 mm Risers available in stainless steel (standard) or *Designer* colors
- Models with simulated stone are Swanstone®

GRSSR-16 in standard Night Sky simulated stone with optional 76 mm Riser in *Designer* color



GRSSR-18 in standard Night Sky simulated stone with optional 127 mm Riser in *Designer* color



GRSSR-20 in standard Night Sky simulated stone

GRSSR20-DL77516 in standard Night Sky simulated stone with standard Black base and lamp



PORTABLE ROUND HEATED SIMULATED STONE SHELVES

Model	Dimensions	Voltage	Watts	Ship Weight	List Price
	Dia. x H	Single Phase			
GRSSR-16	406 x 67 mm	220	190	6 kg	₹72065
GRSSR-18	457 x 67 mm	220	265	7 kg	76893
GRSSR-20	508 x 67 mm	220	330	8 kg	81721

All Round Heated Simulated Stone Shelf Models Feature:

Temperature Range: 38°-93°C.
Cord Location: Back side on base.

PORTABLE ROUND HEATED SIMULATED STONE SHELF WITH DECORATIVE LAMP

Model	Dimensions	Voltage	Watts	Ship Weight	List Price
	W x D x H	Single Phase			
GRSSR20-DL77516	508 x 572 x 914 mm	220-230	550-600	15 kg	₹124179

All Round Heated Simulated Stone Shelf Models with Decorative Lamp Feature:

Bulb: One, 250 Watt clear bulb, uncoated.
Temperature Range: 38°-93°C.
Cord Location: Back side on base.
Lamp Distance: 415 mm space from bottom of shade to base.

OPTIONS AND ACCESSORIES – PAGE 77

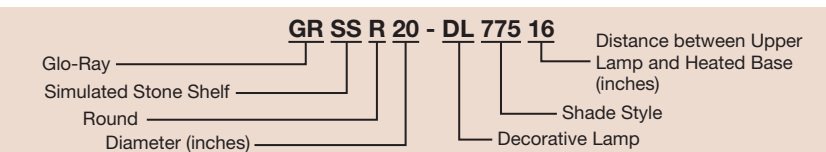
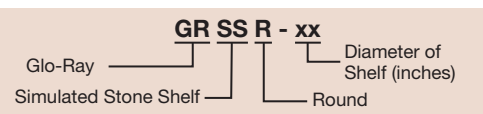



Two GRSSR20-DL77516 units in optional Gray Granite simulated stone and standard Designer Black Base and Shade

OPTIONS (available at time of purchase only)

Designer color Base (and Lamp for GRSSRxx-DL77516 models) – Non-Standard colors are non-returnable – Black Standard –

RED	Warm Red	No Charge
GRAY	Gray Granite	No Charge
WHITE	White Granite	No Charge
NAVY	Navy Blue	No Charge
GREEN	Hunter Green	No Charge
COPPER	Antique Copper	No Charge

Simulated stone colors – Non-standard colors are non-returnable – Night Sky Standard –

SS-GGRAN	Gray Granite	No Charge
SS-BSAND	Bermuda Sand	No Charge

76 mm Risers – Available in Designer colors and Stainless Steel (not available on the GRSSR20-DL77516) –

Non-standard colors are non-returnable –

3RISER16	GRSSR-16	₹3621
3RISER18	GRSSR-18	3621
3RISER20	GRSSR-20	3621

127 mm Risers – Available in Designer colors and Stainless Steel (not available on the GRSSR20-DL77516) –

Non-standard colors are non-returnable –

5RISER16	GRSSR-16	₹4757
5RISER18	GRSSR-18	4757
5RISER20	GRSSR-20	4757

ACCESSORIES

WHITE-CTD-240	250 Watt, 240V, Clear Bulb, Coated (GRSSR20-DL77516 accommodates one bulb)	₹4473
---------------	--	-------

COLORS AND FINISHES – INSIDE BACK COVER

Glo-Ray® Portable Rectangular Heated Simulated Stone Shelves

Match the heat zone to your countertops with Hatco's Glo-Ray® Heated Simulated Stone Shelves. The portable foodsafe shelves come in three simulated stone colors and are ideal for buffet lines or as hors d'oeuvre displays. These unique warmers will safely hold food hot while blending in with your décor.

- Hatco Heated Simulated Stone Shelves are made of approved foodsafe materials
- Features a lighted rocker switch, cord & plug and thermostatically-controlled heated base to help hold your food hot and delicious
- Models with simulated stone are Swanstone®



GRSS-3618 in optional Bermuda Sand simulated stone view of base



GRSS-3618 in standard Night Sky simulated stone

PORTABLE RECTANGULAR HEATED SIMULATED STONE SHELVES

Model	Dimensions W x D x H	Voltage Single Phase	Watts	Ship Weight	List Price
GRSS-2418	610 x 457 x 64 mm	220	534	13 kg	₹107778
GRSS-3018	762 x 457 x 64 mm	220	655	14 kg	112819
GRSS-3618	914 x 457 x 64 mm	220	782	16 kg	117647
GRSS-4818*	1219 x 457 x 159 mm	220	1068	21 kg	127232
GRSS-6018*	1524 x 457 x 159 mm	220	1310	26 kg	165714
GRSS-7218*	1829 x 457 x 159 mm	220	1564	31 kg	175157

* Height includes standard 102 mm legs.

All Portable Heated Simulated Stone Shelf Models Feature:

Cord Location: center of side with switch.

OPTIONS (available at time of purchase only)

Simulated stone color – Non-standard colors are non-returnable – Night Sky Standard –

SS-GGRAN	Gray Granite	No Charge
SS-BSAND	Bermuda Sand	No Charge

COLORS AND FINISHES – INSIDE BACK COVER

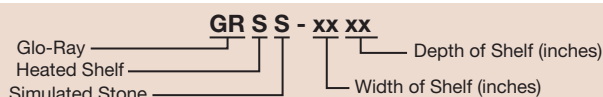

Portable Rectangular Heated Base Glass Shelves

The Hatco Heated Base Glass Shelf has a heated ceramic glass surface to create uniform heat across the entire surface and is made of approved foodsafe material. Adjustable thermostatic controls allow surface temperature ranging from 38° to 90°C to be easily controlled.

- Lighted On/Off rocker switch
- Equipped with a trim mounting ring that is available in stainless steel (standard), White or *Designer Black*
- All units come with a 1829 mm cord and plug



HBG-2418



HBG-FS-24 Black angled Food Stop (detail view) with HBG-TRIM-BLK optional *Designer Black* trim ring



HBG-2418 in Standard Black Glass and Stainless Steel trim ring



HBG-2418 with optional White Glass, Frame and Trim Ring

PORTABLE RECTANGULAR HEATED BASE GLASS SHELVES

Model	Dimensions W x D x H	Voltage Single Phase	Watts	Ship Weight	List Price
HBG-2418	619 x 467 x 64 mm	220-230	420-459	14 kg	₹150520
HBG-3018	772 x 467 x 64 mm	220-230	525-574	15 kg	157336
HBG-3618*	924 x 467 x 156 mm	220-230	630-689	17 kg	164152
HBG-4818*+	1219 x 467 x 156 mm	220-230	840-918	19 kg	177926
HBG-6018*+	1534 x 467 x 156 mm	220-230	1050-1148	28 kg	191629
HBG-7218*+	1838 x 467 x 156 mm	220-230	1260-1378	31 kg	205261

* Height includes standard 102 mm legs.

+ Units 1219 mm and larger are constructed of two equal sized pieces of glass which create a seam.

All Portable Heated Base Glass Shelves Feature:

Cord Location: Center of side with switch.

OPTIONS (available at time of purchase only)

Ceramic Glass Color – Black standard		No Charge
HBG-GLASS-WHT	White	
Angled Food Stop keeps product on the heat zone – Choose size/color		
610 mm	HBG-FS-24 <i>Designer Black</i>	HBG-FSW-24 White each ₹ 7881
672 mm	HBG-FS-30 <i>Designer Black</i>	HBG-FSW-30 White each 9372
914 mm	HBG-FS-36 <i>Designer Black</i>	HBG-FSW-36 White each 10934
1219 mm	HBG-FS-48 <i>Designer Black</i>	HBG-FSW-48 White each 12496
1524 mm	HBG-FS-60 <i>Designer Black</i>	HBG-FSW-60 White each 14058
1829 mm	HBG-FS-72 <i>Designer Black</i>	HBG-FSW-72 White each 15549
Trim Ring color – Stainless Steel standard		₹ 2556
HBG-TRIM-BLK	Black	HBG-TRIM-WHT White
Frame (base) color – Black standard – Non-standard colors are non-returnable –		No Charge
HBG-FRAME-WHT	White	

COLORS AND FINISHES – INSIDE BACK COVER

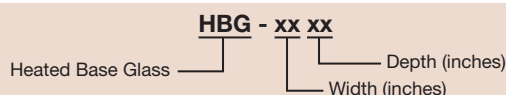

Portable Heated Base Glass Shelf Modular

Hatco's ceramic glass creates uniform heat across the entire top surface. The new design uses a modular system, so units can be placed side-by-side. This allows great flexibility in buffet areas. Each unit's glass surface is the size of a 1/1 GN food pan.

- Electronic temperature control with five settings for 55°, 65°, 75°, 85° and 95°C
- The portable, modular system design offers great flexibility
- Simple design for easy cleaning and maintenance
- Durable stainless steel housing



A series of **HGSM-4060**



HGSM-4060

PORTABLE HEATED BASE GLASS SHELF MODULAR

Model	Dimensions W x D x H	Voltage Single Phase	Watts	Ship Weight	List Price
HGSM-4060	400 x 600 x 58 mm	230	300	8 kg	₹35145

All Portable Heated Base Glass Modular Shelf Models Feature:
Cord Location: Left back of unit.

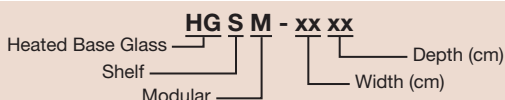

Glo-Ray® Portable Heated Shelves

Whether you need a heated workspace or extra base heat in a pass-through or buffet area, Hatco's full line of Glo-Ray® Heated Shelf options can help you. Using a blanket heating element for an even temperature, the thermostatically-controlled base safely extends the holding time of your food.

Flexibility, style and quality mark these workhorses of the buffet. Available in a variety of depths to meet your specific needs.

- Uniform heat distribution with blanket-type element
- Built-in adjustable thermostat controls surface temperature
- Extruded aluminum base with stainless steel top – optional hardcoated aluminum surface
- Optional 102 mm legs (standard on 914 mm and wider models)
- Optional slant leg kit and pan rail
- Model widths from 457 to 1829 mm
- Model depths: 152, 197, 248, 305, 349, 394, 400, 445, 495, 546, 597, 648 mm

continued on next page...



GRS-30-I in optional *Designer* color with accessory food pans shown below a **GRAH-36** Strip Heater in optional *Designer* color with infinite switch and accessory C-leg stands (cord and plug for units not shown)

PORTABLE HEATED SHELVES

continued on next page...

Model	Dimensions W x H	Voltage Single Phase	Watts	Ship Weight	List Price
495 mm depth I (standard) – accommodates 305 x 508 mm steam table pans					
GRS-18-I	457 x 57 mm	220	229	7 kg	₹ 56800
GRS-24-I	610 x 57 mm	220	320	9 kg	61415
GRS-30-I	762 x 57 mm	220	412	11 kg	66385
GRS-36-I	914 x 133 mm	220	503	13 kg	70645
GRS-42-I	1067 x 133 mm	220	549	15 kg	78526
GRS-48-I	1219 x 133 mm	220	640	16 kg	82928
GRS-54-I	1372 x 133 mm	220	732	19 kg	87898
GRS-60-I	1524 x 133 mm	220	823	20 kg	92300
GRS-66-I	1676 x 133 mm	220	915	23 kg	96773
GRS-72-I	1829 x 133 mm	220	1006	25 kg	101317

152 mm depth A					
GRS-18-A	457 x 57 mm	220	91	5 kg	₹42671
GRS-24-A	610 x 57 mm	220	114	5 kg	44020
GRS-30-A	762 x 57 mm	220	137	6 kg	45795
GRS-36-A	914 x 133 mm	220	160	7 kg	47357
GRS-42-A	1067 x 133 mm	220	205	9 kg	52256
GRS-48-A	1219 x 133 mm	220	228	9 kg	53747
GRS-54-A	1372 x 133 mm	220	251	10 kg	55167
GRS-60-A	1524 x 133 mm	220	274	11 kg	56232
GRS-66-A	1676 x 133 mm	220	297	12 kg	57794
GRS-72-A	1829 x 133 mm	220	320	13 kg	59072

197 mm depth B					
GRS-18-B	457 x 57 mm	220	91	5 kg	₹43452
GRS-24-B	610 x 57 mm	220	114	5 kg	45795
GRS-30-B	762 x 57 mm	220	137	6 kg	48138
GRS-36-B	914 x 133 mm	220	160	7 kg	50268
GRS-42-B	1067 x 133 mm	220	205	9 kg	55167
GRS-48-B	1219 x 133 mm	220	228	9 kg	56800
GRS-54-B	1372 x 133 mm	220	251	10 kg	58646
GRS-60-B	1524 x 133 mm	220	274	11 kg	60634
GRS-66-B	1676 x 133 mm	220	297	12 kg	62409
GRS-72-B	1829 x 133 mm	220	320	13 kg	65249

Model	Dimensions W x H	Voltage Single Phase	Watts	Ship Weight	List Price
248 mm depth C					
GRS-18-C	457 x 57 mm	220	114	5 kg	₹45795
GRS-24-C	610 x 57 mm	220	160	5 kg	48138
GRS-30-C	762 x 57 mm	220	206	6 kg	50694
GRS-36-C	914 x 133 mm	220	252	7 kg	53108
GRS-42-C	1067 x 133 mm	220	274	9 kg	58646
GRS-48-C	1219 x 133 mm	220	320	9 kg	60634
GRS-54-C	1372 x 133 mm	220	366	10 kg	62835
GRS-60-C	1524 x 133 mm	220	412	11 kg	66385
GRS-66-C	1676 x 133 mm	220	458	12 kg	68373
GRS-72-C	1829 x 133 mm	220	504	13 kg	70645

305 mm depth D					
GRS-18-D	457 x 57 mm	220	183	5 kg	₹47357
GRS-24-D	610 x 57 mm	220	229	6 kg	50694
GRS-30-D	762 x 57 mm	220	274	8 kg	53747
GRS-36-D	914 x 133 mm	220	320	9 kg	56232
GRS-42-D	1067 x 133 mm	220	412	10 kg	62409
GRS-48-D	1219 x 133 mm	220	457	12 kg	65675
GRS-54-D	1372 x 133 mm	220	503	13 kg	68373
GRS-60-D	1524 x 133 mm	220	548	15 kg	71213
GRS-66-D	1676 x 133 mm	220	594	16 kg	74195
GRS-72-D	1829 x 133 mm	220	640	17 kg	76964

349 mm depth E					
GRS-18-E	457 x 57 mm	220	183	6 kg	₹49132
GRS-24-E	610 x 57 mm	220	229	7 kg	52256
GRS-30-E	762 x 57 mm	220	274	9 kg	55806
GRS-36-E	914 x 133 mm	220	320	10 kg	59072
GRS-42-E	1067 x 133 mm	220	412	11 kg	65675
GRS-48-E	1219 x 133 mm	220	457	13 kg	69083
GRS-54-E	1372 x 133 mm	220	503	14 kg	72562
GRS-60-E	1524 x 133 mm	220	548	15 kg	75686
GRS-66-E	1676 x 133 mm	220	594	17 kg	78526
GRS-72-E	1829 x 133 mm	220	640	18 kg	82431

All Portable Heated Shelves Feature:

- Pan Capacity (305 x 508 mm): GRS-18-I, -24-I = 1-pan
 GRS-30-I, -36-I = 2-pan
 GRS-42-I, -48-I = 3-pan
 GRS-54-I, -60-I = 4-pan
 GRS-66-I, -72-I = 5-pan

Cord Location: Center of side with controls.

OPTIONS AND ACCESSORIES – PAGE 82

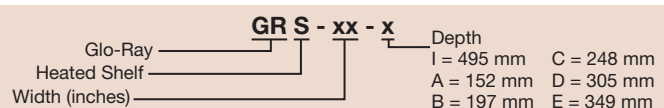

Glo-Ray® Portable Heated Shelves

continued...



GRS-30-I in optional Designer color with accessory pan rail and food pans

PORTABLE HEATED SHELVES continued from previous page

Model	Dimensions W x H	Voltage Single Phase	Watts	Ship Weight	List Price	Model	Dimensions W x H	Voltage Single Phase	Watts	Ship Weight	List Price
394 mm depth						546 mm depth					
GRS-18-F	457 x 57 mm	220	183	6 kg	₹50268	GRS-18-J	457 x 57 mm	220	274	9 kg	₹ 59072
GRS-24-F	610 x 57 mm	220	229	8 kg	53747	GRS-24-J	610 x 57 mm	220	343	12 kg	64681
GRS-30-F	762 x 57 mm	220	274	10 kg	57439	GRS-30-J	762 x 57 mm	220	412	14 kg	69722
GRS-36-F	914 x 133 mm	220	320	11 kg	60634	GRS-36-J	914 x 133 mm	220	480	15 kg	74550
GRS-42-F	1067 x 133 mm	220	412	13 kg	68373	GRS-42-J	1067 x 133 mm	220	618	16 kg	82928
GRS-48-F	1219 x 133 mm	220	457	15 kg	71852	GRS-48-J	1219 x 133 mm	220	686	17 kg	88395
GRS-54-F	1372 x 133 mm	220	503	17 kg	75686	GRS-54-J	1372 x 133 mm	220	755	20 kg	93578
GRS-60-F	1524 x 133 mm	220	548	18 kg	79591	GRS-60-J	1524 x 133 mm	220	823	22 kg	98477
GRS-66-F	1676 x 133 mm	220	594	19 kg	82928	GRS-66-J	1676 x 133 mm	220	892	24 kg	104015
GRS-72-F	1829 x 133 mm	220	640	20 kg	86691	GRS-72-J	1829 x 133 mm	220	961	26 kg	109127
400 mm depth						597 mm depth					
GRS-18-G	457 x 57 mm	220	206	6 kg	₹50694	GRS-18-K	457 x 57 mm	220	297	9 kg	₹ 62409
GRS-24-G	610 x 57 mm	220	274	8 kg	54173	GRS-24-K	610 x 57 mm	220	389	12 kg	67876
GRS-30-G	762 x 57 mm	220	343	10 kg	57794	GRS-30-K	762 x 57 mm	220	480	14 kg	72988
GRS-36-G	914 x 133 mm	220	412	11 kg	61415	GRS-36-K	914 x 133 mm	220	572	15 kg	78526
GRS-42-G	1067 x 133 mm	220	480	13 kg	69722	GRS-42-K	1067 x 133 mm	220	686	16 kg	87898
GRS-48-G	1219 x 133 mm	220	549	15 kg	72988	GRS-48-K	1219 x 133 mm	220	778	17 kg	93578
GRS-54-G	1372 x 133 mm	220	618	17 kg	76964	GRS-54-K	1372 x 133 mm	220	869	20 kg	98903
GRS-60-G	1524 x 133 mm	220	686	18 kg	80798	GRS-60-K	1524 x 133 mm	220	961	22 kg	104938
GRS-66-G	1676 x 133 mm	220	755	19 kg	84845	GRS-66-K	1676 x 133 mm	220	1052	24 kg	110547
GRS-72-G	1829 x 133 mm	220	823	20 kg	87898	GRS-72-K	1829 x 133 mm	220	1144	26 kg	115730
445 mm depth						648 mm depth					
GRS-18-H	457 x 57 mm	220	206	7 kg	₹53108	GRS-18-L	457 x 57 mm	220	320	9 kg	₹ 64681
GRS-24-H	610 x 57 mm	220	274	9 kg	56800	GRS-24-L	610 x 57 mm	220	435	12 kg	70645
GRS-30-H	762 x 57 mm	220	343	11 kg	60634	GRS-30-L	762 x 57 mm	220	549	15 kg	76183
GRS-36-H	914 x 133 mm	220	412	12 kg	65675	GRS-36-L	914 x 133 mm	220	663	17 kg	82431
GRS-42-H	1067 x 133 mm	220	480	14 kg	73485	GRS-42-L	1067 x 133 mm	220	755	20 kg	92300
GRS-48-H	1219 x 133 mm	220	549	16 kg	77461	GRS-48-L	1219 x 133 mm	220	869	23 kg	98477
GRS-54-H	1372 x 133 mm	220	618	18 kg	81650	GRS-54-L	1372 x 133 mm	220	984	25 kg	104583
GRS-60-H	1524 x 133 mm	220	686	20 kg	86691	GRS-60-L	1524 x 133 mm	220	1098	27 kg	110547
GRS-66-H	1676 x 133 mm	220	755	21 kg	90738	GRS-66-L	1676 x 133 mm	220	1212	29 kg	116795
GRS-72-H	1829 x 133 mm	220	823	23 kg	94430	GRS-72-L	1829 x 133 mm	220	1327	31 kg	122901

All Portable Heated Shelf Models Feature:
Cord Location: Center of side with controls.

OPTIONS (available at time of purchase only)

Designer colors (top surface not painted) – Non-standard colors are non-returnable – Clear Anodized Standard –		
RED	Warm Red	₹10437
BLACK	Black	10437
GRAY	Gray Granite	10437
WHITE	White Granite	10437
NAVY	Navy Blue	10437
GREEN	Hunter Green	10437
COPPER	Antique Copper	10437

Hardcoated Surface in lieu of stainless steel on standard 495 mm deep GRS models only (please consult factory for pricing of other depths)

HC 18-42	GRS-18 through GRS-42	₹12496
HC 48-72	GRS-48 through GRS-72	21087
GRS-RECTH	Thermostat Guard	No Charge

ACCESSORIES

GRS-LEGS	102 mm Adjustable Legs (standard on units GRS-36 and larger)	₹3337
GRS-SLANT	Slant Leg Kit for models 305 mm deep or deeper	1704
Chrome Pan Rail for 495 mm deep GRS models –		
2 RAIL	2-pan	₹11005
3 RAIL	3-pan	11786
4 RAIL	4-pan	22081
5 RAIL	5-pan	22791

FOOD PANS AND TRIVETS – PAGE 143 COLORS AND FINISHES – INSIDE BACK COVER

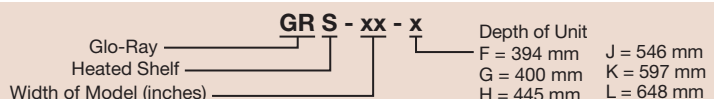
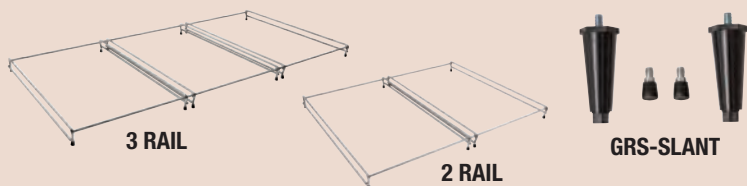

Glo-Ray® Mini-Merchandisers

Hatco's convenient Mini-Merchandisers create impulse sales by placing fresh product in front of customers. Using a limited amount of valuable counterspace, these flexible warmers come in a variety of shapes, sizes and colors to hold food samples, hors d'oeuvres and packaged product.

- Ideal for delis, supermarkets, convenience stores, kiosks or concession stands where counterspace is limited
- Sturdy acrylic sneeze guard safeguards food serving areas
- Lighted rocker switch for easy On/Off
- Shatter-resistant incandescent lights enhance product displays while safeguarding food from bulb breakage
- Thermostatically-controlled heated base to extend holding times of most foods
- Pre-focused infrared top heat directs heat to the outer edges where heat loss is greatest
- Food stop and 102 mm food bins standard (GRHW-1SG only)



GRHW-1SG



GRHW-2P with
102 mm legs and
accessory food pans

MINI-MERCHANDISERS

Model	Description	Dimensions	Base	Voltage	Watts	Ship Weight	List Price
		W x D x H Includes sneeze guard	Dimensions W x D				
GRHW-1P	Hors d'oeuvres warmer, 2 bulbs	565 x 414 x 451 mm	533 x 349 mm	220	782	16 kg	₹112322
GRHW-2P	Hors d'oeuvres warmer, 4 bulbs	1099 x 414 x 527 mm	1067 x 349 mm	220	1560	31 kg	148177
GRHW-1SG	Single horizontal shelf, 2 bulbs	565 x 414 x 451 mm	533 x 349 mm	220	782	17 kg	133906

All Mini-Merchandiser Models Feature:

Included with Merchandiser: Thermostatically-controlled base, 191 mm sneeze guard, display lights, 25 mm rubber legs (except GRHW-2P has 102 mm legs), five 102 mm bins (GRHW-1SG only) and 1829 mm cord and plug.

Cord Location: Base end plate, same side as switch.

OPTIONS (available at time of purchase only)

Designer colors – Non-standard colors are non-returnable – Clear Anodized Aluminum Standard –

RED	Warm Red	₹25560
BLACK	Black	25560
GRAY	Gray Granite	25560
WHITE	White Granite	25560
NAVY	Navy Blue	25560
GREEN	Hunter Green	25560
COPPER	Antique Copper	25560
PANEL	Plexi-Glass side panels	12141

ACCESSORIES

Chef LED 230V adjustable bulb – See page 49 for more information –

₹7171

CLED-2700-230 Warm incandescent **CLED-3000-230** Warm halogen **CLED-4000-230** Cool fluorescent

4"LEGS 102 mm Adjustable Legs (standard on GRHW-2P) ₹3337

FOOD PANS AND TRIVETS – PAGE 143

COLORS AND FINISHES – INSIDE BACK COVER



Chef LED Bulb

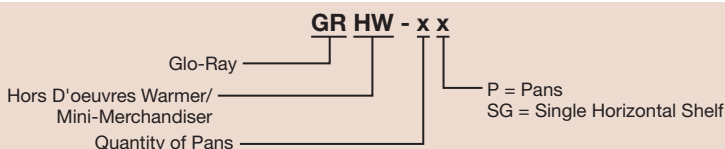

Glo-Ray® Buffet Warmers

Hold hot food at optimum serving temperatures in buffet lines or in temporary serving areas with Hatco Glo-Ray® Buffet Warmers. Choose from either standard or Designer style models in many widths to fit your operation.

- Available with Designer color insets (GR2BW only) and the choice of an entire unit in color as well
- Thermostatically-controlled heated base of 27°-93°C extends holding times of most foods
- Pre-focused infrared top heat directs heat to the outer edges where heat loss is greatest
- Sturdy plexi-glass sneeze guard
- Shatter-resistant incandescent lights enhance product displays while safeguarding food from bulb breakage
- Available in a variety of widths from 635-1988 mm



GRBW-30 with optional Designer color and accessory food pans



GR2BW-30 with optional Designer Red inset panels and accessory food pans



GR2BW-30 in optional Designer color with plexi-glass side enclosures and accessory food pans

BUFFET WARMERS

Model	No. Of Light Bulbs	Dimensions W x D x H Includes sneeze guard	Maximum Pan Capacity 305 x 508 mm pan	Voltage Single Phase	Watts	Ship Weight	List Price
GRBW-24	2	638 x 572 x 451 mm	1	220	920	21 kg	₹121765
GRBW-30	2	791 x 572 x 451 mm	2	220	1172	24 kg	134403
GRBW-36	3	943 x 572 x 527 mm	2	220	1454	26 kg	147041
GRBW-42	3	1095 x 572 x 527 mm	3	220	1648	31 kg	159679
GRBW-48	4	1248 x 572 x 527 mm	3	220	1940	35 kg	172317
GRBW-54	4	1400 x 572 x 527 mm	4	220	2182	37 kg	184955
GRBW-60	5	1553 x 572 x 527 mm	4	220	2474	41 kg	197593
GRBW-66	5	1705 x 572 x 527 mm	5	220	2726	44 kg	210231
GRBW-72	5	1857 x 572 x 527 mm	5	220	2983	49 kg	222869

All Buffet Warmer Models Feature:

GRBW Base Dimensions: 638-1857 W x 495 D mm.
Cord Location: Base end plate, same side as switch.

DESIGNER BUFFET WARMERS

Model*	No. Of Light Bulbs	Dimensions W x D x H Includes sneeze guard	Maximum Pan Capacity 305 x 508 mm pan	Voltage Single Phase	Watts	Ship Weight	List Price
GR2BW-24	2	768 x 686 x 483 mm	1	220	950	34 kg	₹215272
GR2BW-30	2	921 x 686 x 483 mm	2	220	1210	39 kg	235365
GR2BW-36	2	1073 x 686 x 483 mm	2	220	1450	44 kg	255458
GR2BW-42	4	1226 x 686 x 559 mm	3	220	1750	50 kg	281941
GR2BW-48	4	1378 x 686 x 559 mm	3	220	2000	57 kg	308424
GR2BW-54	4	1530 x 686 x 559 mm	4	220	2250	59 kg	340232
GR2BW-60	6	1683 x 686 x 559 mm	4	220	2600	70 kg	372040
GR2BW-66	6	1835 x 686 x 559 mm	5	220	2860	77 kg	398168
GR2BW-72	6	1988 x 686 x 559 mm	5	220	3125	84 kg	424296

* When no color is specified, color inset panels and corner caps will be black.

All Designer Buffet Warmer Models Feature:

Usable Heated Shelf Space: Width of unit minus 165 x 552 D mm.
Cord Location: Center of bottom on control side.

OPTIONS AND ACCESSORIES – PAGE 85

FOOD PANS AND TRIVETS – PAGE 143

BUFFET WARMER MAXIMUM PAN CAPACITIES

Model	Pan Capacity
GRBW-24, GR2BW-24:	1 full size pan
GRBW-30, -36, GR2BW-30, -36:	2 full size pans
GRBW-42, -48, GR2BW-42, -48:	3 full size pans
GRBW-54, -60, GR2BW-54, -60:	4 full size pans
GRBW-66, -72, GR2BW-66, -72:	5 full size pans

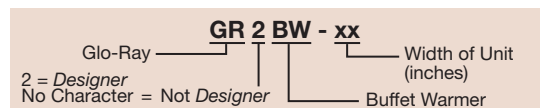



GRBW-30 with accessory food pans

OPTIONS (available at time of purchase only)

Designer Colors – Clear Anodized Aluminum Standard –

Non-standard colors are non-returnable –

₹25560

RED	Warm Red	BLACK	Black	GRAY	Gray Granite	COPPER	Antique Copper
WHITE	White Granite	NAVY	Navy Blue	GREEN	Hunter Green		

Designer Inset Panel colors, GR2BW models – Black Standard –

Non-standard colors are non-returnable –

No Charge

RED	Warm Red	GRAY	Gray Granite	GREEN	Hunter Green	COPPER	Antique Copper
WHITE	White Granite	NAVY	Navy Blue				

Designer Corner Caps, GR2BW models – Black Standard –

Non-standard colors are non-returnable –

No Charge

DKGRAY	Dark Gray
---------------	-----------

Acrylic Front and two Side Enclosures in lieu of Sneeze Guards (available for GRBW-24, -30, -36, -42, & -48 models only)

FRTENCL-24, -30	-24, -30 models	₹23288
FRTENCL-36, -42, -48	-36, -42, -48 models	26625
SIDE-ENCL	Two Acrylic Side Enclosures (GRBW models only)	15833
SIDE-ENCL2	Two Acrylic Side Enclosure (GR2BW models only)	15833

Hardcoated Surface, GRBW models –

HC 24-42	GRBW-24 through GRBW-42	₹ 8307
HC 48-72	GRBW-48 through GRBW-72	16614
INF	Infinite Control for Top Heat Only (GRBW-24 through -60 and GR2BW-24 through -60 models only)	1917
9.375BP	238 mm Sneeze Guard in lieu of standard 191 mm (GRBW models only)	add per 305 mm per side 568
14BP	356 mm Sneeze Guard in lieu of standard 191 mm	add per 305 mm per side 1349

ACCESSORIES

GRBW-LEGS	102 mm Adjustable Legs for GRBW-24 model (standard on GRBW-36 or larger)	₹3337
2SD-LEGS	102 mm Designer Legs for GR2BW-24 model (standard on GR2BW-30 or larger)	6319
Pan Rail for GRBW models (not for use with Acrylic Front Enclosure)		
2 RAIL	2-pan	₹11005
3 RAIL	3-pan	11786
4 RAIL	4-pan	22081
5 RAIL	5-pan	22791
Chef LED 230V adjustable bulb – See page 49 for more information –		
CLED-2700-230	Warm incandescent	CLED-3000-230 Warm halogen
		CLED-4000-230 Cool fluorescent

FOOD PANS AND TRIVETS – PAGE 143
COLORS AND FINISHES – INSIDE BACK COVER



Chef LED Bulb

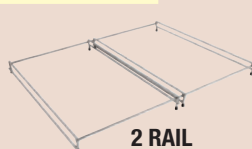

2 RAIL



3 RAIL



2SD-LEGS

Built-Ins

Cafeterias • Buffets
Supermarkets & Delis • Restaurants & Cafés



CSSBFX-48-S in optional Bermuda Sand built into a Bermuda Sand simulated stone countertop *pg. 87*



HCSBFX-48-S in hot mode *pg. 89*



HCSBFX-48-S in cold mode *pg. 89*



GRSSB-3618 in standard Night Sky simulated stone *pg. 92*



GRSSB-3618 in optional Bermuda Sand simulated stone built into a simulated stone countertop below a GR2AH-42 Strip Heater *pg. 92*



HBGB-3618 built into a simulated stone countertop *pg. 93*



HBGB-3618 in optional White Ceramic Glass *pg. 93*

Cold Simulated Stone Shelves Built-In without Condenser

These sturdy, foodsafe shelves are a must for buffet lines in cafeterias, restaurants and much more!

They have the benefit of allowing fabricators the freedom to design.

- Condensing unit not included
- Patented thermal break reduces condensation and temperature transfer
- Both CSSBX and CSSBFX models are bottom mount units
- Models with simulated stone are Swanstone®
- CSSBX models match the Glo-Ray® Built-In Rectangular Heated Simulated Stone Shelves (GRSSB) for a fully integrated look
- Self-adhesive silicone gasket included



CSSBX-4818
in optional
Bermuda Sand
simulated stone



CSSBFX-48-S
in optional
Gray Granite
simulated stone

COLD SIMULATED STONE SHELVES BUILT-IN WITHOUT CONDENSER (flush to the counter top)

Model	Overall Shelf Dim. (includes brackets) W x D	Usable Space W x D	Watts 220V, 230V, 240V	Approximate Ship Weight	List Price
CSSBX-2418	686 x 533 mm	607 x 457 mm	17	35 kg	₹290674
CSSBX-3018	383 x 533 mm	762 x 457 mm	17	40 kg	294579
CSSBX-3618	991 x 533 mm	914 x 457 mm	17	46 kg	307572
CSSBX-4818	1295 x 533 mm	1219 x 457 mm	17	53 kg	365366

All Cold Simulated Stone Shelf Built-In Remote Without Condenser Models Feature:
Voltage: 220, 230 or 240.

Models Shipped with: Shelf assembly with temperature probe, solenoid valve (attached to shelf), control panel (shipped loose) and TXV valve (unattached).

COLD SIMULATED STONE SHELVES BUILT-IN FLUSH TOP WITHOUT CONDENSER

Model	Overall Shelf Dim. (includes brackets) W x D	Usable Space W x D	Watts 220V, 230V, 240V	Approximate Ship Weight	List Price
CSSBFX-24-F	686 x 470 mm	610 x 394 mm	17	32 kg	₹289893
CSSBFX-24-I	686 x 572 mm	610 x 495 mm	17	36 kg	291455
CSSBFX-24-S	686 x 686 mm	610 x 610 mm	17	41 kg	304661
CSSBFX-36-F	991 x 470 mm	914 x 394 mm	17	45 kg	305868
CSSBFX-36-I	991 x 572 mm	914 x 495 mm	17	50 kg	307572
CSSBFX-36-S	991 x 686 mm	914 x 610 mm	17	56 kg	383258
CSSBFX-48-F	1295 x 470 mm	1219 x 394 mm	17	45 kg	363378
CSSBFX-48-I	1295 x 572 mm	1219 x 495 mm	17	56 kg	365295
CSSBFX-48-S	1295 x 686 mm	1219 x 610 mm	17	64 kg	448649

All Cold Simulated Stone Shelf Built-In Flush Top Without Condenser Models Feature:
Voltage: 220, 230 or 240.

Models Shipped with: Shelf assembly with temperature probe, solenoid valve (attached to shelf), control panel (shipped loose) TXV valve (unattached).

OPTIONS AND ACCESSORIES – PAGE 89

COLORS AND FINISHES – INSIDE BACK COVER

COUNTERTOP CUTOUT DIMENSIONS

Model	Width with 10 mm radii	Depth with 10 mm radii
CSSBX-2418	619 mm	467 mm
CSSBX-3018	772 mm	467 mm
CSSBX-3618	924 mm	467 mm
CSSBX-4818	1229 mm	467 mm
CSSBFX-24-F	619 mm	403 mm
CSSBFX-24-I	619 mm	505 mm
CSSBFX-24-S	619 mm	619 mm
CSSBFX-36-F	924 mm	403 mm
CSSBFX-36-I	924 mm	505 mm
CSSBFX-36-S	924 mm	619 mm
CSSBFX-48-F	1229 mm	403 mm
CSSBFX-48-I	1229 mm	505 mm
CSSBFX-48-S	1229 mm	619 mm
Model	Width	Height
Control Box	242 mm	197 mm

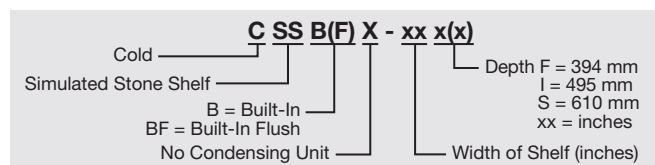



Hot/Cold Shelves Built-In without Condenser

Give your operation ultimate flexibility with these patented shelves. Available in our signature Aluminum Hardcoat or in simulated stone, they easily transition between a heated to cold and cold to heated shelf!

They have the benefit of allowing fabricators the freedom to design.

- Condensing unit not included
- Patented thermal break reduces condensation and temperature transfer.
- Shelves change modes from hot to cold or vice versa in as little as 30 minutes, allowing quick change for different dayparts
- Self-adhesive silicone gasket included with HCSSB(F)X models
- Simulated stone models HCSSB(F)X are bottom mount, flush with counter top
- Models with simulated stone are Swanstone®
- HCSSBX models match the Glo-Ray® Built-In Rectangular Heated Simulated Stone Shelves (GRSSB) for a fully integrated look
- Hardcoat aluminum models (HCSBFX) are top mount
- The flush mount control comes standard with a 1219 mm lead wire
- HCSBFX models match the Glo-Ray® Built-In Rectangular Heated Shelves with Flush Top (GRSFB) for a fully integrated look

continued on next page...



HCSSBX-4818
in optional
Bermuda Sand
simulated stone



HCSSBFX-48-S
in standard
Night Sky
simulated stone

HOT/COLD SIMULATED STONE SHELVES BUILT-IN WITHOUT CONDENSER (flush to the counter top)

Model	Overall Shelf Dim. (includes brackets)	Shelf Space W x D	Hot Side Watts 220V, 230V, 240V	Approx. Ship Weight	List Price
	W x D				
HCSSBX-2418	686 x 533 mm	607 x 457 mm	371, 405, 441	35 kg	₹356349
HCSSBX-3018	838 x 533 mm	762 x 457 mm	467, 510, 555	48 kg	361177
HCSSBX-3618	991 x 533 mm	914 x 457 mm	558, 610, 664	57 kg	369910
HCSSBX-4818	1295 x 533 mm	1219 x 457 mm	746, 815, 887	64 kg	420036

All Hot/Cold Simulated Stone Shelf Built-In Without Condenser Models Feature:

Voltage: 220, 230 or 240.

Models Shipped with: Shelf assembly with temperature probes, solenoid valve (attached to shelf), control panel (shipped loose) and TXV valve (unattached).

HOT/COLD SIMULATED STONE SHELVES BUILT-IN FLUSH TOP WITHOUT CONDENSER

Model	Overall Shelf Dim. (includes brackets)	Shelf Space W x D	Hot Side Watts 220V, 230V, 240V	Approx. Ship Weight	List Price
	W x D				
HCSSBFX-24-F	686 x 470 mm	610 x 394 mm	325, 355, 387	32 kg	₹354432
HCSSBFX-24-I	686 x 572 mm	610 x 495 mm	407, 445, 485	40 kg	356349
HCSSBFX-24-S	686 x 686 mm	610 x 610 mm	503, 550, 599	48 kg	360751
HCSSBFX-36-F	991 x 470 mm	914 x 394 mm	485, 530, 577	46 kg	368064
HCSSBFX-36-I	991 x 572 mm	914 x 495 mm	613, 670, 730	56 kg	369910
HCSSBFX-36-S	991 x 686 mm	914 x 610 mm	755, 825, 898	62 kg	427278
HCSSBFX-48-F	1295 x 470 mm	1219 x 394 mm	650, 710, 773	59 kg	385033
HCSSBFX-48-I	1295 x 572 mm	1219 x 495 mm	814, 890, 969	77 kg	422947
HCSSBFX-48-S	1295 x 686 mm	1219 x 610 mm	1006, 1100, 1198	75 kg	533565

All Hot/Cold Simulated Stone Shelf Built-In Flush Top Without Condenser Models Feature:

Voltage: 220, 230 or 240.

Models Shipped with: Shelf assembly with temperature probe, solenoid valve (attached to shelf), control panel (shipped loose) TXV valve (unattached).

OPTIONS AND ACCESSORIES – PAGE 89

COLORS AND FINISHES – INSIDE BACK COVER

COUNTERTOP CUTOUT DIMENSIONS

Model	Width with 10 mm radii	Depth with 10 mm radii
	HCSSBX-2418	619 mm
HCSSBX-3018	772 mm	467 mm
HCSSBX-3618	924 mm	467 mm
HCSSBX-4818	1229 mm	467 mm
HCSSBFX-24-F	619 mm	403 mm
HCSSBFX-24-I	619 mm	505 mm
HCSSBFX-24-S	619 mm	619 mm
HCSSBFX-36-F	921 mm	403 mm
HCSSBFX-36-I	921 mm	505 mm
HCSSBFX-36-S	921 mm	619 mm
HCSSBFX-48-F	1226 mm	403 mm
HCSSBFX-48-I	1226 mm	505 mm
HCSSBFX-48-S	1226 mm	619 mm
Model	Width	Height
Control Box	372 mm	197 mm

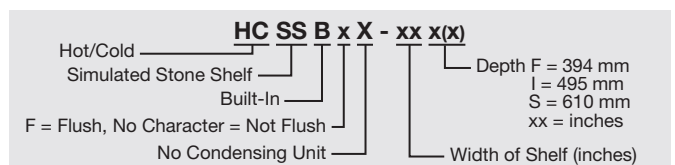

Hot/Cold Shelves Built-In without Condenser

continued...



HCSBFX-48-S

HOT/COLD SHELVES BUILT-IN FLUSH TOP (Aluminum Hardcoat) WITHOUT CONDENSER

Model	Overall Dimensions W x D	Usable Shelf Space W x D	Hot Side Watts 220V, 230V, 240V	Approximate Ship Weight	List Price
HCSBFX-24-F	648 x 432 mm	610 x 394 mm	325, 355, 387	34 kg	₹340303
HCSBFX-24-I	648 x 533 mm	610 x 495 mm	407, 445, 485	39 kg	342149
HCSBFX-24-S	648 x 648 mm	610 x 610 mm	503, 550, 599	44 kg	348397
HCSBFX-36-F	953 x 432 mm	914 x 394 mm	485, 530, 577	50 kg	354645
HCSBFX-36-I	953 x 533 mm	914 x 495 mm	613, 670, 730	52 kg	355639
HCSBFX-36-S	953 x 648 mm	914 x 610 mm	755, 825, 898	54 kg	414569
HCSBFX-48-F	1257 x 432 mm	1219 x 394 mm	650, 710, 773	55 kg	410593
HCSBFX-48-I	1257 x 533 mm	1219 x 495 mm	814, 890, 969	58 kg	411587
HCSBFX-48-S	1257 x 648 mm	1219 x 610 mm	1006, 1100, 1198	67 kg	460222

All Hot/Cold Shelf Built-In Flush Top Without Condenser Models Feature:

Voltage: 220, 230 or 240.

Models Shipped with: Shelf assembly with temperature probes, solenoid valve (attached to shelf), control panel (shipped loose) and TXV valve (unattached).

OPTIONS (available at time of purchase only)

Simulated Stone color – not available for HCSBFX models – Non-standard colors are non-returnable Night Sky standard –

SS-GGRAN	Gray Granite	No Charge
SS-BSAND	Bermuda Sand	No Charge

COLORS AND FINISHES – INSIDE BACK COVER

COUNTERTOP CUTOUT DIMENSIONS

Model	Width		Depth	
	Min.	Max.	Min.	Max.
HCSBFX-24-F	625 mm	635 mm	409 mm	419 mm
HCSBFX-24-I	625 mm	635 mm	511 mm	521 mm
HCSBFX-24-S	625 mm	635 mm	625 mm	635 mm
HCSBFX-36-F	930 mm	940 mm	409 mm	419 mm
HCSBFX-36-I	930 mm	940 mm	511 mm	521 mm
HCSBFX-36-S	930 mm	940 mm	625 mm	635 mm
HCSBFX-48-F	1234 mm	1245 mm	409 mm	419 mm
HCSBFX-48-I	1234 mm	1245 mm	511 mm	521 mm
HCSBFX-48-S	1234 mm	1245 mm	625 mm	635 mm
Model	Width		Height	
Control Box	372 mm		197 mm	

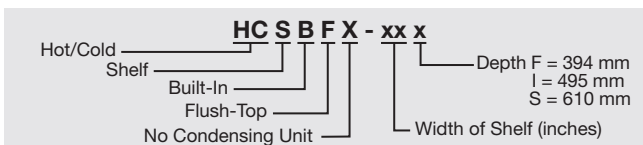



April 1, 2020

Cold Shelves Built-In Flush Top without Condenser

These shelves are designed to keep your pre-chilled beverages, hors d'oeuvres, side dishes, buffet items and more in the perfect chill zone.

They have the benefit of allowing fabricators the freedom to design.

- Condensing unit not included
- Patented thermal break reduces condensation and temperature transfer
- Top mounted hardcoat aluminum surface
- Matches the Glo-Ray® Built-In Rectangular Heated Shelves with Flush Top (GRSBF) for a fully integrated look



CSBFX-48-S
(Flush Top)

COLD SHELVES BUILT-IN FLUSH TOP (Aluminum Hardcoat) WITHOUT CONDENSER

Model	Overall Shelf Dimensions	Usable Shelf Space	Watts	Approximate Ship Weight	List Price
	W x D	W x D			
CSBFX-24-F	648 x 432 mm	610 x 394 mm	17	29 kg	₹274557
CSBFX-24-I	648 x 533 mm	610 x 495 mm	17	33 kg	276048
CSBFX-24-S	648 x 648 mm	610 x 610 mm	17	36 kg	281444
CSBFX-36-F	953 x 432 mm	914 x 394 mm	17	35 kg	282722
CSBFX-36-I	953 x 533 mm	914 x 495 mm	17	42 kg	284284
CSBFX-36-S	953 x 648 mm	914 x 610 mm	17	50 kg	342220
CSBFX-48-F	1257 x 432 mm	1219 x 394 mm	17	43 kg	332564
CSBFX-48-I	1257 x 533 mm	1219 x 495 mm	17	51 kg	334339
CSBFX-48-S	1257 x 648 mm	1219 x 610 mm	17	56 kg	382974

All Cold Shelf Built-In Flush Top Without Condenser Models Feature:

Voltage: 220, 230 or 240.

Models Shipped with: Shelf assembly with temperature probe, solenoid valve (attached to shelf), control panel (shipped loose) and TXV valve (unattached).

COUNTERTOP CUTOUT DIMENSIONS

Model	Width		Depth	
	Minimum	Maximum	Minimum	Maximum
CSBFX-24-F	625 mm	635 mm	409 mm	419 mm
CSBFX-24-I	625 mm	635 mm	511 mm	521 mm
CSBFX-24-S	625 mm	635 mm	625 mm	635 mm
CSBFX-36-F	930 mm	940 mm	409 mm	419 mm
CSBFX-36-I	930 mm	940 mm	511 mm	521 mm
CSBFX-36-S	930 mm	940 mm	625 mm	635 mm
CSBFX-48-F	1234 mm	1245 mm	409 mm	419 mm
CSBFX-48-I	1234 mm	1245 mm	511 mm	521 mm
CSBFX-48-S	1234 mm	1245 mm	625 mm	635 mm
Control Box	242 mm		197 mm	

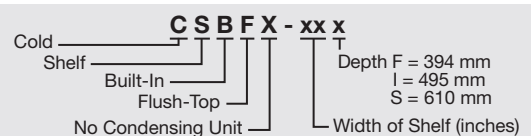

Cold Shelves Undermount without Condenser

These shelves mount directly against the underside of a granite, quartz, stainless steel or appropriate simulated stone countertop (no cutout required). Cooling transfers through the countertop to the top surface, without puncturing, for a true, seamless look.

They have the benefit of allowing fabricators the freedom to design.

- Condensing unit not included
- Mount under appropriate countertop material for a seamless look
- Aluminum surface
- Approved materials include granite and quartz up to 30 mm, Swanstone® as provided by Hatco and certain stainless steel or aluminum surfaces approved by Hatco. Please contact the factory for applications with other material.*



CSUX-48-S
(Undermount)

COLD SHELVES UNDERMOUNT (Aluminum) WITHOUT CONDENSER

Model	Overall Shelf Dim. (includes brackets) W x D	Shelf Space W x D	Watts	Approximate Ship Weight	List Price
CSUX-24-F	694 x 478 mm	610 x 394 mm	17	34 kg	₹251340
CSUX-24-I	694 x 579 mm	610 x 495 mm	17	32 kg	252831
CSUX-24-S	694 x 694 mm	610 x 610 mm	17	39 kg	256523
CSUX-36-F	998 x 478 mm	914 x 394 mm	17	45 kg	250417
CSUX-36-I	998 x 579 mm	914 x 495 mm	17	44 kg	251127
CSUX-36-S	998 x 694 mm	914 x 610 mm	17	45 kg	302176
CSUX-48-F	1303 x 478 mm	1219 x 394 mm	17	44 kg	291668
CSUX-48-I	1303 x 579 mm	1219 x 495 mm	17	59 kg	293372
CSUX-48-S	1303 x 694 mm	1219 x 610 mm	17	45 kg	329724

All Cold Shelf Undermount Without Condenser Models Feature:

Voltage: 220, 230 or 240.

Models Shipped with: Shelf assembly with temperature probe, solenoid valve (attached to shelf), control panel (shipped loose) and TXV valve (unattached).

*Make structural modifications or add bracing underneath the countertop to ensure countertop will support the weight of the unit and its contents.

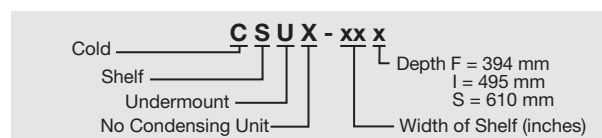



April 1, 2020

Glo-Ray® Built-In Rectangular Heated Simulated Stone Shelves

Match the heat zone to your countertops with Hatco's Glo-Ray® Heated Simulated Stone Shelves. The built-in foodsafe shelves are ideal for buffet lines or hors d'oeuvre displays. These unique warmers will safely hold food hot while blending in with your décor.

- Hatco Heated Stone Simulated Shelves are made of approved foodsafe materials
- Three simulated stone colors for shelf: Gray Granite, Bermuda Sand and Night Sky (standard) – non-standard colors are non-returnable
- Features a lighted rocker switch and thermostatically-controlled heated base
- Includes remote control box with 915 mm conduit and 1829 mm cord and plug
- Models with simulated stone are Swanstone®



GRSSB-3618 in optional Bermuda Sand simulated stone built into a Bermuda Sand simulated stone countertop

Be sure to check out our Hot/Cold and Cold only Built-In Shelves for a seamless look

BUILT-IN RECTANGULAR HEATED SIMULATED STONE SHELVES

Model [^]	Dimensions W x D x H	Voltage Single Phase	Watts	Ship Weight	List Price
GRSSB-2418	651 x 498 x 57 mm	220	534	14 kg	₹116937
GRSSB-3018	803 x 498 x 57 mm	220	655	20 kg	121694
GRSSB-3618	956 x 498 x 57 mm	220	782	22 kg	126735
GRSSB-4818	1260 x 498 x 57 mm	220	1068	23 kg	138947
GRSSB-6018	1565 x 498 x 57 mm	220	1310	25 kg	181902
GRSSB-7218	1870 x 498 x 57 mm	220	1564	32 kg	189357

[^]Recommended for use in a metallic countertop. For other surfaces, verify that the material is suitable for temperatures up to 93°C.

All Built-in Rectangular Heated Simulated Stone Shelf Models Feature:
Cord Location: Cord is attached to Control Box.



Standard Control Box

OPTIONS (available at time of purchase only)

Designer Color Bezel (Flush Mount Control Box Bezel for GRSSB models only) – Stainless Steel Standard
Non-standard colors are non-returnable –

RED	Warm Red	₹2556
BLACK	Black	2556
GRAY	Gray Granite	2556
WHITE	White Granite	2556
NAVY	Navy Blue	2556
GREEN	Hunter Green	2556
COPPER	Antique Copper	2556

Simulated stone colors – Non-standard colors are non-returnable – Night Sky Standard –

SS-GGRAN	Gray Granite	No Charge
SS-BSAND	Bermuda Sand	No Charge
GRSSB-FLUSH-TSTAT	Flush Mount Thermostatic Control Box in Stainless Steel with Lighted Power Switch	No Charge
GRSSB-REC	Built-in Heated Simulated Stone Shelf with Recessed Top	No Charge



GRSSB-FLUSH-TSTAT
Optional Flush Mount recessed *Thermostatic* Control Box with lighted On/Off rocker switch and angled recessed controls

COLORS AND FINISHES – INSIDE BACK COVER

BUILT-IN RECTANGULAR HEATED SIMULATED STONE SHELVES CUTOUT DIMENSIONS

Model	Minimum Width	Maximum Width	Minimum Depth	Maximum Depth
GRSSB-2418	625 mm	632 mm	473 mm	480 mm
GRSSB-3018	778 mm	784 mm	473 mm	480 mm
GRSSB-3618	930 mm	937 mm	473 mm	480 mm
GRSSB-4818	1235 mm	1241 mm	473 mm	480 mm
GRSSB-6018	1540 mm	1546 mm	473 mm	480 mm
GRSSB-7218	1845 mm	1851 mm	473 mm	480 mm

OPTIONAL CONTROL BOX CUTOUT DIMENSIONS

Model	Width	Height	Depth
GRSSB-FLUSH-TSTAT	149 mm	174 mm	102 mm

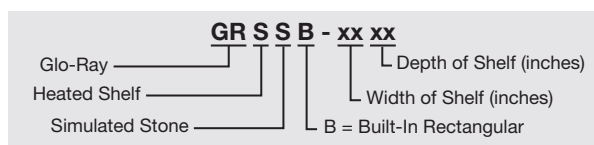

Built-In Rectangular Heated Base Glass Shelves

Hatco Heated Base Glass Shelves have a heated ceramic glass top to create uniform heat across the entire surface and are made of approved foodsafe materials. Adjustable thermostatic controls allow surface temperature to be easily controlled.

- Shelves are made of approved foodsafe materials
- Equipped with an attached stainless steel trim mounting ring (optional Designer Black or Smooth White available)
- Lighted On/Off rocker switch
- Includes remote control box with 915 mm conduit and 1829 mm cord and plug

HBGB-3618 with optional White Glass



HBGBH-2418

HBGB-2418 with optional Designer Black Trim Ring



BUILT-IN RECTANGULAR HEATED BASE GLASS SHELVES

Model [^]	Dimensions (W x D x H)	Voltage (Single Phase)	Watts	Ship Weight	List Price
HBGB-2418	654 x 502 x 57 mm	220-230	420-459	15 kg	₹163939
HBGB-3018	806 x 502 x 57 mm	220-230	525-574	17 kg	170968
HBGB-3618	959 x 502 x 57 mm	220-230	630-689	18 kg	178139
HBGB-4818 ⁺	1264 x 502 x 57 mm	220-230	840-918	23 kg	195463
HBGB-6018 ⁺	1568 x 502 x 57 mm	220-230	1050-1148	29 kg	209308
HBGB-7218 ⁺	1873 x 502 x 57 mm	220-230	1260-1378	34 kg	223366

[^]Recommended for use in a metallic countertop. For other surfaces, verify that the material is suitable for temperatures up to 93°C.
⁺ Units 1219 mm and greater are constructed of two equal size pieces of glass which create a seam.

All Built-in Rectangular Heated Base Glass Shelf Models Feature:

Temperature Range: 38°-93°C. Cord location: Cord with plug is attached to Control Box.

BUILT-IN RECTANGULAR HIGH-WATT HEATED BASE GLASS SHELVES

Model [^]	Dimensions (W x D x H)	Voltage (Single Phase)	Watts	Ship Weight	List Price
HBGBH-2418	654 x 502 x 57 mm	230	634	13 kg	₹173737
HBGBH-3018	806 x 502 x 57 mm	230	809	15 kg	180269
HBGBH-3618	959 x 502 x 57 mm	230	984	17 kg	187014
HBGBH-4818 ⁺	1264 x 502 x 57 mm	230	1268	21 kg	203557
HBGBH-6018 ⁺	1568 x 502 x 57 mm	230	1618	25 kg	216621
HBGBH-7218 ⁺	1873 x 502 x 57 mm	230	1968	29 kg	230182

[^]Recommended for use in a metallic countertop. For other surfaces, verify that the material is suitable for temperatures up to 125°C.

⁺ Units 1219 mm and greater are constructed of two equal size pieces of glass which create a seam.

All Built-in Rectangular Heated Base Glass High-Watt Shelf Models Feature:

Cord location: Cord is attached to Control Box.

Conduit:1829 mm



Standard HBGBH Flush Mount recessed Electronic Control Box with lighted On/Off rocker switch and angled recessed controls (HBGBH models only)

OPTIONS AND ACCESSORIES – PAGE 94

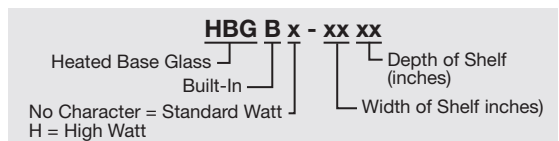



April 1, 2020



HBGB-2418 mounted into a Swanstone® counter top

OPTIONS (available at time of purchase only)

Ceramic Glass Color – Black Standard – Non-standard colors are non-returnable –		No Charge
HBGB-GLASS-WHT	White	
Designer Color Bezel (Flush Mount Control Box, Bezel only) – Stainless Steel Standard – Non-standard colors are non-returnable –		
HBGB-BEZEL-BLACK	Black	₹2556
HBGB-BEZEL-WHITE	White	2556
Trim Ring Color – Stainless Steel Standard – Non-standard colors are non-returnable –		
HBGB-TRIM-BLK	Designer Black	2556
HBGB-TRIM-WHITE	White	2556
HBGB-FLUSH-TSTAT	Flush Mount Thermostatic stainless steel Control Box with Lighted Power Switch – HBGB models only	No Charge
HBGB-REC	Built-In Heated Base Glass Shelf with Recessed Top – HBGB models only	No Charge
HBGBH-NO-TRIM	Unit without Trim Ring – HBGBH models only	No Charge
COND-3	915 mm Conduit in lieu of standard 1830 mm (used with Flush Mount ITC Control Box) – HBGBH models only	2556
COND-10	3050 mm Conduit in lieu of standard 1830 mm (used with Flush Mount ITC Control Box) – HBGBH models only	4686



HBGB-FLUSH-TSTAT Optional Flush Mount recessed Thermostatic Control Box with lighted On/Off rocker switch and angled recessed controls (HBGB models only)

HEATED AND HIGH-WATT HEATED BASE GLASS SHELF COUNTERTOP CUTOUT DIMENSIONS

Model	Minimum Width	Maximum Width	Minimum Depth	Maximum Depth
HBGB, HBGBH-2418	625 mm	632 mm	473 mm	480 mm
HBGB, HBGBH-3018	778 mm	784 mm	473 mm	480 mm
HBGB, HBGBH-3618	930 mm	937 mm	473 mm	480 mm
HBGB, HBGBH-4818	1235 mm	1241 mm	473 mm	480 mm
HBGB, HBGBH-6018	1540 mm	1546 mm	473 mm	480 mm
HBGB, HBGBH-7218	1845 mm	1851 mm	473 mm	480 mm

CONTROL BOX CUTOUT DIMENSIONS

Model	Width	Height	Depth
HBGB-FLUSH-TSTAT	149 mm	174 mm	102 mm
HBGBH Standard Box	149 mm	174 mm	102 mm
GRSB-FLUSH-TSTAT	149 mm	174 mm	102 mm

Glo-Ray® Built-In Rectangular Heated Shelves with Recessed Top

Let Hatco add heat to your serving surface with the Glo-Ray® Built-In Rectangular Heated Shelf with Recessed Top. This 13 mm recessed top food warmer has a hardcoated aluminum top and blanket-type element for uniform heat to extend your food holding time.

- Uniform heat distribution with hardcoated aluminum top and blanket-type element
- 914 mm flexible conduit channels power lines from the shelf to a control box
- Standard controller includes, infinite switch, lighted rocker switch and mounting brackets
- Thermostatically-controlled heated base



Standard Control Box



GRSB-24-I

NOTE: For any size GRSB, the next larger size GRAH Strip Heater will fit over the top. For example, a GRSB-30 will require a GRAH-36. The GRAH will have a tight fit to the frame of the base.

BUILT-IN RECTANGULAR HEATED SHELVES WITH RECESSED TOP

Model*	Dimensions	Cut-Out Dimensions		Voltage	Watts	Ship Weight	List Price
	W x D x H	Min.-Max. Width	Min.-Max. Depth	Single Phase			
GRSB-24-F	648 x 432 x 73 mm	622-629 mm	406-413 mm	220	384	11 kg	₹102453
GRSB-24-I	648 x 533 x 73 mm	622-629 mm	508-514 mm	220	550	13 kg	102879
GRSB-30-F	800 x 432 x 73 mm	775-781 mm	406-413 mm	220	462	11 kg	109127
GRSB-30-I	800 x 533 x 73 mm	775-781 mm	508-514 mm	220	665	13 kg	109553
GRSB-36-F	953 x 432 x 73 mm	927-933 mm	406-413 mm	220	540	13 kg	115943
GRSB-36-I	953 x 533 x 73 mm	927-933 mm	508-514 mm	220	780	14 kg	116369
GRSB-36-O	953 x 800 x 73 mm	927-933 mm	775-781 mm	220	1110	17 kg	135042
GRSB-42-F	1105 x 432 x 73 mm	1080-1086 mm	406-413 mm	220	627	14 kg	121623
GRSB-42-I	1105 x 533 x 73 mm	1080-1086 mm	508-514 mm	220	885	17 kg	122191
GRSB-48-F	1257 x 432 x 73 mm	1232-1238 mm	406-413 mm	220	705	15 kg	128013
GRSB-48-I	1257 x 533 x 73 mm	1232-1238 mm	508-514 mm	220	1000	18 kg	128439
GRSB-48-O	1257 x 800 x 73 mm	1232-1238 mm	775-781 mm	220	1430	31 kg	159466
GRSB-54-I	1410 x 533 x 73 mm	1384-1391 mm	508-514 mm	220	1110	18 kg	134900
GRSB-60-F	1562 x 432 x 73 mm	1537-1543 mm	406-413 mm	220	870	18 kg	141077
GRSB-60-I	1562 x 533 x 73 mm	1537-1543 mm	508-514 mm	220	1220	20 kg	141645
GRSB-60-O	1562 x 800 x 73 mm	1537-1543 mm	775-781 mm	220	1750	29 kg	185168
GRSB-66-I	1715 x 533 x 73 mm	1689-1695 mm	508-514 mm	220	1330	24 kg	147041
GRSB-72-F	1867 x 432 x 73 mm	1842-1848 mm	406-413 mm	220	1034	20 kg	152366
GRSB-72-I	1867 x 533 x 73 mm	1842-1848 mm	508-514 mm	220	1440	23 kg	153005
GRSB-72-O	1867 x 800 x 73 mm	1842-1848 mm	775-781 mm	220	2070	31 kg	211083

* Recommended for use in a metallic countertop. For other surfaces, verify that the material is suitable for temperatures up to 93°C.

All Built-In Rectangular Heated Shelf with Recessed Top Models Feature:

Usable Heated Shelf Space: Width of unit minus 38 mm x depth of unit minus 38 mm.

Cord location: Cord is attached to Control Box.

OPTIONS (available at time of purchase only)

Designer Color Bezel (Flush Mount Control Box, Bezel only) – Stainless Steel Standard –

Non-standard colors are non-returnable –

RED	Warm Red	₹2556
BLACK	Black	2556
GRAY	Gray Granite	2556
WHITE	White Granite	2556
NAVY	Navy Blue	2556
GREEN	Hunter Green	2556
COPPER	Antique Copper	2556
GRSB-FLUSH-TSTAT	Flush Mount Thermostatic Stainless Steel Control Box with Lighted Power Switch*	No Charge

* See page 94 for Control Box cutout dimensions.



GRSB-FLUSH-TSTAT Optional Flush mount Recessed Thermostatic Control Box with lighted On/Off rocker switch and angled recessed controls

FOOD PANS AND TRIVETS – PAGE 143
COLORS AND FINISHES – INSIDE BACK COVER

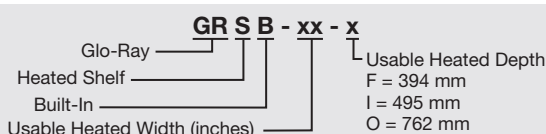



April 1, 2020

Glo-Ray® Built-In Rectangular Heated Shelves with Flush Top

Let Hatco add heat to your serving surface with the Glo-Ray® Built-in Heated Shelf. This flush surface foodwarmer has a hardcoated aluminum top and blanket-type element for uniform heat to extend your food holding time.

- Uniform heat distribution with hardcoated aluminum top and blanket-type element
- 914 mm flexible conduit channels power lines from the shelf to a control box
- Standard controller includes, infinite switch, lighted rocker switch and mounting brackets
- Thermostatically-controlled heated base
- Model widths from: 648 to 1867 mm
- Optional stainless steel surface



GR5BF-60-0 built into a simulated stone countertop with accessory food pans shown below a **GR2AL-96D** Strip Heater in *Designer* color with optional sneeze guards

NOTE: For any size GRSBF, the next larger size GRAH Strip Heater will fit over the top. For example, a GRSBF-30 will require a GRAH-36. The GRAH will have a tight fit to the frame of the base.



Standard Control Box

BUILT-IN RECTANGULAR HEATED SHELVES WITH FLUSH TOP

Model*	Dimensions W x D x H	Cut-Out Dimensions		Voltage Single Phase	Watts	Shipping Weight	List Price
		Min.-Max. Width	Min.-Max. Depth				
GR5BF-24-F	648 x 432 x 57 mm	622-629 mm	406-413 mm	220	384	13 kg	₹102453
GR5BF-24-I	648 x 533 x 57 mm	622-629 mm	508-514 mm	220	550	12 kg	102879
GR5BF-24-S	648 x 648 x 57 mm	622-629 mm	622-629 mm	220	640	15 kg	108914
GR5BF-30-F	800 x 432 x 57 mm	775-781 mm	406-413 mm	220	462	11 kg	109127
GR5BF-30-I	800 x 533 x 57 mm	775-781 mm	508-514 mm	220	665	14 kg	109553
GR5BF-30-S	800 x 648 x 57 mm	775-781 mm	622-629 mm	220	755	15 kg	117931
GR5BF-36-F	953 x 432 x 57 mm	927-933 mm	406-413 mm	220	540	15 kg	115943
GR5BF-36-I	953 x 533 x 57 mm	927-933 mm	508-514 mm	220	780	14 kg	116369
GR5BF-36-S	953 x 648 x 57 mm	927-933 mm	622-629 mm	220	870	16 kg	131066
GR5BF-36-O	953 x 800 x 57 mm	927-933 mm	775-781 mm	220	1110	17 kg	135042
GR5BF-42-F	1105 x 432 x 57 mm	1080-1086 mm	406-413 mm	220	627	17 kg	121623
GR5BF-42-I	1105 x 533 x 57 mm	1080-1086 mm	508-514 mm	220	885	15 kg	122191
GR5BF-42-S	1105 x 648 x 57 mm	1080-1086 mm	622-629 mm	220	1006	18 kg	143491
GR5BF-48-F	1257 x 432 x 57 mm	1232-1238 mm	406-413 mm	220	705	16 kg	128013
GR5BF-48-I	1257 x 533 x 57 mm	1232-1238 mm	508-514 mm	220	1000	18 kg	128439
GR5BF-48-S	1257 x 648 x 57 mm	1232-1238 mm	622-629 mm	220	1121	19 kg	154212
GR5BF-48-O	1257 x 800 x 57 mm	1232-1238 mm	775-781 mm	220	1430	22 kg	159466
GR5BF-60-F	1562 x 432 x 57 mm	1537-1543 mm	406-413 mm	220	870	19 kg	141077
GR5BF-60-I	1562 x 533 x 57 mm	1537-1543 mm	508-514 mm	220	1220	22 kg	141645
GR5BF-60-S	1562 x 648 x 57 mm	1537-1543 mm	622-629 mm	220	1372	25 kg	180198
GR5BF-60-O	1562 x 800 x 57 mm	1537-1543 mm	775-781 mm	220	1750	29 kg	185168
GR5BF-72-F	1867 x 432 x 57 mm	1842-1848 mm	406-413 mm	220	1034	20 kg	152366
GR5BF-72-I	1867 x 533 x 57 mm	1842-1848 mm	508-514 mm	220	1440	24 kg	153005
GR5BF-72-S	1867 x 648 x 57 mm	1842-1848 mm	622-629 mm	220	1602	27 kg	202776
GR5BF-72-O	1867 x 800 x 57 mm	1842-1848 mm	775-781 mm	220	1894	31 kg	211083

* Recommended for use in a metallic countertop. For other surfaces, verify that the material is suitable for temperatures up to 93°C.

All Built-In Rectangular Heated Shelf with Flush Top Models Feature:

Usable Heated Shelf Space: Width of unit minus 38 mm x depth of unit minus 38 mm.

Cord location: Cord is attached to Control Box.

OPTIONS (available at time of purchase only)

Designer Color Bezel (Flush Mount Control Box, Bezel only) – Stainless Steel Standard – Non-standard colors are non-returnable –

RED	Warm Red	₹2556
BLACK	Black	2556
GRAY	Gray Granite	2556
WHITE	White Granite	2556
NAVY	Navy Blue	2556
GREEN	Hunter Green	2556
COPPER	Antique Copper	2556
GR5BF-SS	Stainless Steel Surface in lieu of Hardcoat (GR5BF models only)	No Charge
GR5BF-FLUSH-TSTAT	Flush Mount Thermostatic Stainless Steel Control Box with Lighted Power Switch*	No Charge

* See page 94 for Control Box cutout dimensions.



GR5BF-FLUSH-TSTAT
Optional flush mount recessed *thermostatic* control box with lighted On/Off rocker switch and angled recessed controls

FOOD PANS AND TRIVETS – PAGE 143
COLORS AND FINISHES – INSIDE BACK COVER

Be sure to check out our Hot/Cold and Cold only Built-In Shelves for a seamless look

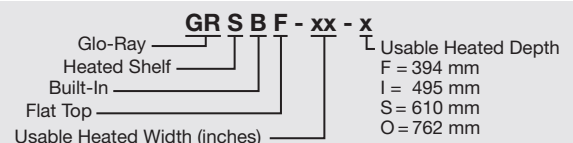

Drawer Warmers

*Cafeterias • Convenience Stores
Restaurants & Cafés • Clubs & Bars • Concessions*



CDW-3N pg. 98



HDW-2 pg. 99



HDW-3 pg. 99



HDW-1.5R2 with optional Touch Screen Control (TTC) pg. 99



HDW-1N with HDW-ITC control Option pg. 99



HDW-2B in optional Designer Warm Red pg. 100



HDW-2B pg. 100

Drawer Warmers

Hold everything from meat to vegetables to rolls in Hatco Drawer Warmers. Built for tough kitchen duty with rugged construction and heavy-duty hardware, these warmers keep a variety of foods hot and fresh until served.

- HDW -1,-2,-3 models come in standard and narrow widths, HWD-4 comes in standard width only
- 1-, 2-, 3- or 4-drawer freestanding or 1-, 2- or 3 split drawer models
- Completely insulated individual cavities provide maximum energy efficiency (excludes HDW-1R2,-2R2)
- Each drawer has a recessed individual thermostatic control, temperature monitor, vent slides and power switch
- 12-gauge stainless steel heavy-duty drawer slides with nylon rollers
- Standard width Drawer Warmer pans lift straight out of drawer (HDW-1N, -2N, -3N and HDW-1R2, -1.5R2, -2R2 models require tipping the pan to install)

Optional Touch Screen Control

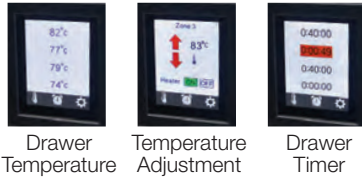

Drawer Temperature Temperature Adjustment Drawer Timer



HDW-2 with optional Touchscreen Control and Accessory 152 mm stainless steel legs



HDW-1.5R2 with optional touchscreen control



HDW-1R2



HDW-2R2



HDW-2N

FREESTANDING DRAWER WARMERS

Model	Dimensions W x D* x H Height excludes legs/casters	Voltage Single Phase	Watts	Ship Weight Includes weight of pans	List Price	
					With pans	Without pans
Standard						
HDW-1	749 x 575 x 279 mm	220	450	44 kg	₹165146	₹161596
HDW-2	749 x 575 x 537 mm	220	900	76 kg	278391	271291
HDW-3	749 x 575 x 794 mm	220	1350	105 kg	391920	381270
HDW-4	749 x 575 x 1051 mm	220	1800	135 kg	516454	502254
Narrow						
HDW-1N	530 x 686 x 279 mm	220	450	44 kg	₹165146	₹161596
HDW-2N	530 x 686 x 537 mm	220	900	76 kg	278391	271291
HDW-3N	530 x 686 x 794 mm	220	1350	105 kg	391920	381270

* Add 32 mm to depth for drawer handle.

All Free Standing Models Feature:

HDW-1, -2, and -3 and all Narrow models shipped with: 102 mm plastic legs, 1829 mm cord and plug.

HDW-4 Shipped with: 152 mm stainless steel legs, 1829 mm cord and plug.

Models w/Pans Shipped with: One 152 mm deep food pan per drawer.

Cord Location: Back of unit, lower left corner.

SPLIT DRAWER WARMERS

Model	Dimensions W x D* x H Height excludes legs/casters	Voltage Single Phase	Watts	Ship Weight Includes weight of pans	List Price	
					With pans	Without pans
HDW-1R2	733 x 419 x 378 mm	230	634	41 kg	₹238418	₹233448
HDW-1.5R2	733 x 419 x 494 mm	230	909	53 kg	335262	327807
HDW-2R2	733 x 419 x 610 mm	230	1185	61 kg	372253	362313

* Add 32 mm to depth for drawer handle.

All Split Drawer Warmers Models Feature:

Cord Location: Back of unit, lower left corner.

Pan Capacity: 527W x 324D x 64H mm.

HDW-1R2 Shipped with: Two 527 x 324 x 64 mm food pans, four 102 mm legs, 1829 mm cord and plug.

HDW-1.5R2 Shipped with: Three 527 x 324 x 64 mm food pans, four 102 mm legs, 1829 mm cord and plug.

HDW-2R2 Shipped with: Four 527 x 324 x 64 mm food pans, four 102 mm legs, 1829 mm cord and plug.

OPTIONS AND ACCESSORIES – PAGE 101

FOOD PANS AND TRIVETS – PAGE 143

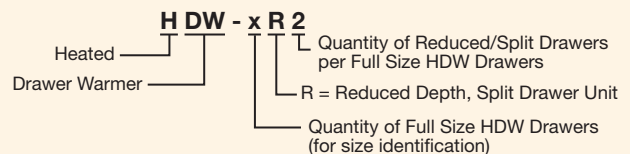
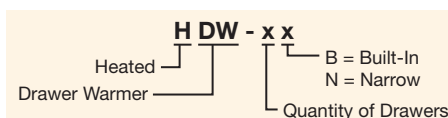

Drawer Warmers

Hold everything from meat to vegetables to rolls in Hatco Drawer Warmers. Built for tough kitchen duty with rugged construction and heavy-duty hardware, these warmers keep a variety of foods hot and fresh until served.

- Standard and narrow widths
- 1-, 2- or 3-drawer built-in models
- Completely insulated individual cavities provide maximum energy efficiency
- Each drawer has a recessed individual thermostatic control, temperature monitor, vent slides and power switch
- 12-gauge stainless steel heavy-duty drawer slides with nylon rollers
- Standard width Drawer Warmer pans lift straight out of drawer (HDW-1BN, -2BN and -3BN models require tipping the pan to install)

Optional Touch Screen Control



Drawer Temperature Temperature Adjustment Drawer Timer

HDW-3B



HDW-2B



BUILT-IN DRAWER WARMER

Model	Dimensions W x D* x H Height excludes front mounting flange	Voltage Single Phase	Watts	Ship Weight Includes weight of pans	List Price	
					With pans (standard)	Without pans
Standard						
HDW-1B	715 x 568 x 248 mm	220	450	40 kg	₹158969	₹155419
HDW-2B	715 x 568 x 506 mm	220	900	72 kg	266818	259718
HDW-3B	715 x 568 x 763 mm	220	1350	106 kg	374454	363804
Narrow						
HDW-1BN	494 x 679 x 248 mm	220	450	40 kg	₹158969	₹155419
HDW-2BN	494 x 679 x 506 mm	220	900	72 kg	266818	259718
HDW-3BN	494 x 679 x 763 mm	220	1350	106 kg	374454	363804

* Add 32 mm to depth for drawer handle.

All Built-In Models Feature:

Models Shipped with: Conduit.

Models w/Pans Shipped with: One 152 mm deep food pan per drawer.

OPTIONS AND ACCESSORIES – PAGE 101

FOOD PANS AND TRIVETS – PAGE 143

BUILT-IN DRAWER WARMER CUT-OUT REQUIREMENTS

Model	“W” Dimension	“D” Dimension [▲]	“H” Dimension
HDW-1B	720 mm	610 mm	257 mm
HDW-2B	720 mm	610 mm	514 mm
HDW-3B	720 mm	610 mm	771 mm
HDW-1BN	500 mm	720 mm	257 mm
HDW-2BN	500 mm	720 mm	514 mm
HDW-3BN	500 mm	720 mm	771 mm

▲ Depth dimension includes 38 mm for conduit connector.

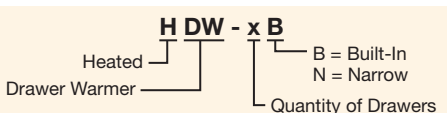

OPTIONS (available at time of purchase only)

Designer Drawer Front Colors per Drawer – Non-standard colors are non-returnable –

RED	Warm Red	₹4189
BLACK	Black	4189
GRAY	Gray Granite	4189
WHITE	White Granite	4189
NAVY	Navy Blue	4189
GREEN	Hunter Green	4189
COPPER	Antique Copper	4189
HDW-TTC	Temperature Control Timer – 6-channel control touchscreen display	₹37914
RD-NOVENT	No Drawer Vents (HWD-1R2, -1.5R2, -2R2 only)	No Charge
OS-PAN	Oversized Drawer Frame and Pan (508 x 381 x 127 mm) in lieu of Standard Drawer with Pan (standard width models only)	per drawer 8662
BIS DRAWER	Biscuit Pan Drawer (accommodates two 457 x 330 mm Half-Size Sheet Pans – not included) in lieu of standard Drawer with Pan (standard width models only)	per drawer No Charge
HDW-CHIP	Chip Guard	2911

ACCESSORIES

HDW 6" LEG	152 mm Adjustable Stainless Steel Legs (standard on HDW-4)	₹11786
HDW-CASTER-2	51 mm diameter Casters – all swivel, 2 lock – adds 57 mm to height of unit (HDW-1, -2, -3 models only)	14555
HDW-CASTER-3	76 mm diameter Locking Casters – all swivel, all lock – adds 108 mm to height of unit (HDW-1, -2, -3 models only)	14555
HDW-CASTER-5	127 mm diameter Locking Casters – all swivel, all lock – adds 159 mm to height of unit	17253
HDW-TRIVET	Custom Trivet (445 x 242 x 13 mm) raises food product 13 mm off bottom of full size pan	3550
HDW-SPILL	Water/Spillage Pan – one per drawer (excludes BIS Drawer and OS-Pan Options)	16401
HDW-SPLASH	Splash Baffle – one per drawer (excludes BIS Drawer and OS-Pan Options)	3266
ST PAN 2	Stainless Steel Food Pan – 527 x 324 x 64 mm	4828
HDW 6" PAN	Stainless Steel Food Pan – 527 x 324 x 152 mm	6674

FOOD PANS AND TRIVETS – PAGE 143



HDW-TTC Option
Shown: Temperature adjustment and timer touchscreen control



Biscuit Pan Drawer (pans not included)
BIS DRAWER Option



HDW 6" LEG accessory

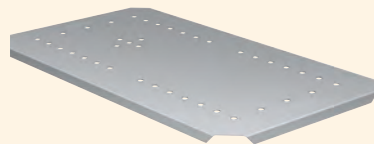

HDW-SPLASH accessory

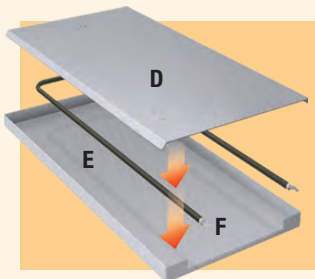

Prevents chips from reaching the element
D. Heat Shield (included)
E. Heating Element (included)
F. Chip Guard **HDW-CHIP** Option (standard width shown)

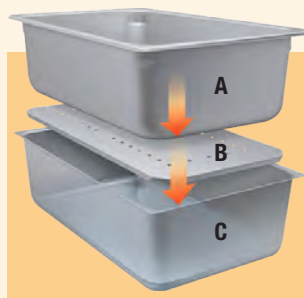

Additional Humidity
A. Stainless Steel Food Pan (included)
B. Splash Baffle
HDW-SPLASH Accessory
C. Water/Spillage Pan (add 6 mm of water)
HDW-SPILL Accessory



CASTERS accessory
HDW-CASTER-2 All swivel, 2 lock
HDW-CASTER-3 All swivel, all lock
HDW-CASTER-5 All swivel, all lock

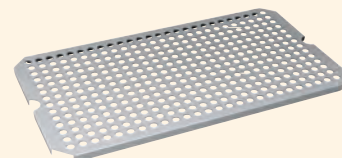

HDW-TRIVET accessory

Heated Merchandisers

*Cafeterias • Convenience Stores
Supermarkets & Delis • Restaurants & Cafés
Clubs & Bars • Catering • Concessions*



Two **GRSDH-36D** with dual horizontal shelves *pg. 104*



GR2SDH-36 with standard *Designer Black* inset panels and corner caps *pg. 106*



HXMS-36D in standard *Designer Black* with optional LED accent lighting in support posts *pg. 108*



GMHD-2PT shown without standard sign holder *pg. 111*



GRCMW-1 and **GRCMW-1DH** with optional Bermuda Sand Simulated Stone color *pg. 112*



GRCD-2PD in optional *Designer Hunter Green* *pg. 113*

Glo-Ray® Merchandising Warmers

Designed with both a slanted and horizontal shelf, Glo-Ray® Merchandising Warmers offer the convenience of customer self-serve with the efficiency of preparing product in advance, and holding for peak serving periods.

- Warmer includes a slant and horizontal shelf for merchandising a variety of products like popcorn on the top shelf and nachos, boxed pizza or wrapped food on the bottom
- Standard Indicating Temperature Control (ITC) enhances accuracy and provides digital readout of temperatures
- Thermostatically-controlled hardcoated heated base to extend holding times
- Pre-focused infrared top heat directs heat to the outer edges where heat loss is greatest
- Product divider rods and 102 mm legs included
- Shatter-resistant incandescent lights illuminate the holding areas and emphasize the product



GRSDS/H-36D with slant and horizontal shelf and optional 381 mm clearance top shelf



GRSDS/H-41D with slant and horizontal shelf

Heated Merchandisers

SLANT/HORIZONTAL DISPLAY WARMERS – DUAL SHELVES – TOP AND BASE HEAT

Model	No. of Bulbs, Divider Rods Per Shelf	Dimensions W x D x H	Voltage Single Phase	Watts	Amps	Ship Weight	List Price
GRSDS/H-36D	4, 7	914 x 616 x 851 mm	220	1669	7.6	72 kg	₹409244
GRSDS/H-41D	6, 8	1041 x 616 x 851 mm	220	1951	8.9	81 kg	₹437573

All Slant/Horizontal Shelf Models Feature:
 Cord Location: 1829 mm. Control side at right base corner.
 Front opening dimension, Top: 305 H mm.
 Bottom: 264 H mm.

OPTIONS (available at time of purchase only)

Designer Colors – Non-standard colors are non-returnable –
 Stainless Steel Standard – Glossy Gray standard –

RED	Warm Red	₹25560
BLACK	Black	25560
GRAY	Gray Granite	25560
WHITE	White Granite	25560
NAVY	Navy Blue	25560
GREEN	Hunter Green	25560
COPPER	Antique Copper	25560
15SPACE	381 mm clearance for top shelf in lieu of standard 305 mm	₹7455

COLORS AND FINISHES – INSIDE BACK COVER

ACCESSORIES

GRSDS-DIV	Additional Stainless Steel Divider Rods (bottom shelf only)	each ₹1491
GRSDH-DIV	Additional Stainless Steel Divider Rods (top shelf only)	each 1491

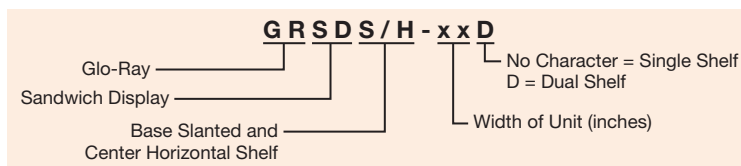

Glo-Ray® Merchandising Warmers

Designed specifically for showcasing wrapped or boxed product, Hatco Glo-Ray® Merchandising Warmers hold hot food safely at proper serving temperatures. These warmers offer the convenience of self-serve and the efficiency of kitchen-to-server, holding product in advance for peak serving periods.

- Available in single- or two-tier models
- Horizontal or slant shelves
- Product divider rods sort food displays
- Thermostatically-controlled hardcoated heated base, with a temperature range of 85°- 93°C, to extend holding times

- Pre-focused infrared top heat directs heat to the outer edges where heat loss is greatest
- Shatter-resistant incandescent lights illuminate the holding areas and emphasize the product



GRSDH-30
Horizontal single shelf



GRSDS-24D
Dual slant shelf
with optional
sign holders
(signs not
included)

Heated Merchandisers

HORIZONTAL DISPLAY WARMERS

Model	No. of Bulbs, Divider Rods	Dimensions (W x D x H) <i>Height includes legs</i>	Voltage Single Phase	Usable Heated Shelf Space (W x D)	Watts	Ship Weight	List Price
Single Shelf							
GRSDH-24	2, 5	610 x 495 x 303 mm	220	577 x 419 mm	724	22 kg	₹173311
GRSDH-30	2, 6	762 x 495 x 303 mm	220	730 x 419 mm	890	25 kg	188718
GRSDH-36	2, 7	914 x 495 x 303 mm	220	882 x 419 mm	1074	30 kg	204196
GRSDH-41	3, 8	1041 x 495 x 379 mm	220	1009 x 419 mm	1228	34 kg	222088
GRSDH-52	4, 10	1321 x 495 x 379 mm	220	1289 x 419 mm	1604	39 kg	258795
GRSDH-60	5, 12	1524 x 495 x 379 mm	220	1492 x 419 mm	1830	60 kg	291242
Dual Shelf							
GRSDH-24D	4, 10	610 x 495 x 303 mm	220	577 x 419 mm	1448	40 kg	₹301821
GRSDH-30D	4, 12	762 x 495 x 643 mm	220	730 x 419 mm	1780	45 kg	312968
GRSDH-36D	4, 14	914 x 495 x 643 mm	220	882 x 419 mm	2148	54 kg	331144
GRSDH-41D	6, 16	1041 x 495 x 643 mm	220	1009 x 419 mm	2456	62 kg	351663
GRSDH-52D*	8, 20	1321 x 495 x 643 mm	220	1289 x 419 mm	3208	78 kg	404771
GRSDH-60D*	10, 24	1524 x 495 x 643 mm	220	1492 x 419 mm	3660	89 kg	445809

* Cord without plug.

All Horizontal Single and Dual Shelf Models Feature:

Cord Location: 1829 mm. Left rear corner toward server side.

SLANT DISPLAY WARMERS

Model	No. of Bulbs, Divider Rods	Dimensions (W x D x H) <i>Height includes legs</i>	Voltage Single Phase	Usable Heated Shelf Space (W x D)	Watts	Ship Weight	List Price
Single Shelf							
GRSDS-24	2, 5	610 x 616 x 469 mm	220	572 x 533 mm	629	36 kg	₹207888
GRSDS-30	2, 6	762 x 616 x 469 mm	220	724 x 533 mm	730	36 kg	222727
GRSDS-36	2, 7	914 x 616 x 545 mm	220	876 x 533 mm	864	42 kg	239554
GRSDS-41	3, 8	1041 x 616 x 545 mm	220	1003 x 533 mm	1003	44 kg	257020
GRSDS-52	4, 10	1321 x 616 x 545 mm	220	1283 x 533 mm	1275	50 kg	294437
GRSDS-60	5, 12	1524 x 616 x 545 mm	220	1486 x 533 mm	1665	76 kg	317867
Dual Shelf							
GRSDS-24D	4, 10	610 x 616 x 820 mm	220	572 x 533 mm	1260	52 kg	₹323263
GRSDS-30D	4, 12	762 x 616 x 820 mm	220	724 x 533 mm	1419	64 kg	342859
GRSDS-36D	4, 14	914 x 616 x 820 mm	220	876 x 533 mm	1669	73 kg	365082
GRSDS-41D	6, 16	1041 x 616 x 820 mm	220	1003 x 533 mm	1951	82 kg	392346
GRSDS-52D	8, 20	1321 x 616 x 820 mm	220	1283 x 533 mm	2483	98 kg	455323
GRSDS-60D*	10, 24	1524 x 616 x 820 mm	220	1486 x 533 mm	3240	108 kg	483439

* Cord without plug.

All Slant Single and Dual Shelf Models Feature:

Cord Location: 1829 mm. Control side at right base corner.

OPTIONS AND ACCESSORIES – PAGE 105

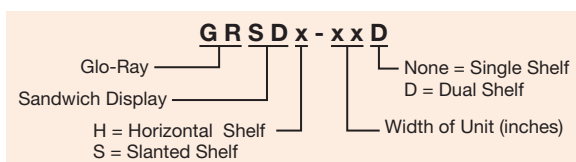



Two GRSDH-36D with dual horizontal shelves

Heated Merchandisers

OPTIONS (available at time of purchase only)

ITC-S	Indicating Temperature Control (LED) for single shelf	₹18673
ITC-D	Indicating Temperature Control (LED) for dual shelf	32163
SSEND	Stainless Steel End Panels in lieu of Glass End Panels	per shelf 2556

127 mm Sneeze Guard on Customer side (GRSDS one side GRSDH two sides) –

GRSD24BP	610 mm wide models	per shelf ₹ 8520
GRSD30BP	762 mm wide models	per shelf 10082
GRSD36BP	914 mm wide models	per shelf 11786
GRSD41BP	1041 mm wide models	per shelf 13490
GRSD52BP	1321 mm wide models	per shelf 15407
GRSD60BP	1524 mm wide models	per shelf 21797
GRSDFLILOCK1	Flip-Up Door Locking Plate for GRSDS-xx, -xxD models -24 to -41	per shelf ₹994
GRSDFLILOCK2	Flip-Up Door Locking Plate for GRSDS-xx, -xxD models -52 to -60	per shelf 2414

Display Sign Holder (Signs not included) Color matches unit color – Top or Intermediate shelf –

GRSDS-24SIGN	610 mm width. Requires 575 W x 100 H x 2 D mm Sign	each ₹4970
GRSDS-30SIGN	762 mm width. Requires 727 W x 100 H x 2 D mm Sign	each 4970
GRSDS-36SIGN	914 mm width. Requires 879 W x 100 H x 2 D mm Sign	each 5964
GRSDS-41SIGN	1041 mm width. Requires 1006 W x 100 H x 2 D mm Sign	each 5964
GRSDS-52SIGN	1321 mm width. Requires 1286 W x 100 H x 2 D mm Sign	each 6887
GRSDS-60SIGN	1524 mm width. Requires 1489 W x 100 H x 2 D mm Sign	each 6887

ACCESSORIES

4"LEGS	102 mm Adjustable Legs (standard on units GRSDH-41 and larger, GRSDS-36 and larger and all duals)	Set of 4 ₹3337
--------	---	----------------

Chef LED Bulbs – 230V adjustable bulb – See page 49 for more information –

CLED-2700-230	Chef LED Bulb (similar to warm Incandescent light)	each ₹7171
CLED-3000-230	Chef LED Bulb (similar to warm Halogen light)	each 7171
CLED-4000-230	Chef LED Bulb (similar to cool Fluorescent light)	each 7171



CLED-2700, -3000 or -4000 Accessory

Plexi-Glass Flip-up Doors on one side for GRSDS models

– Not compatible with optional Sneeze Guards or Display Sign Holders in same opening –

SDS24FLIP	610 mm wide models	per shelf ₹15478
SDS30FLIP	762 mm wide models	per shelf 15478
SDS36FLIP	914 mm wide models	per shelf 15478
SDS41FLIP	1041 mm wide models	per shelf 15478
SDS52FLIP	1321 mm wide models - split doors	per shelf 26412
SDS60FLIP	1524 mm wide models - split doors	per shelf 26412

Plexi-Glass Flip-Up Doors on one side for GRSDH models

– Not compatible with optional Sneeze Guards or Display Sign Holders in same opening –

GRSDH24FLIP	610 mm wide models	per shelf ₹15478
GRSDH30FLIP	762 mm wide models	per shelf 15478
GRSDH36FLIP	914 mm wide models	per shelf 15478
GRSDH41FLIP	1041 mm wide models	per shelf 15478
GRSDH52FLIP	1321 mm wide models - split doors	per shelf 26412
GRSDH60FLIP	1524 mm Wide models - split doors	per shelf 26412
GRSDH-DIV	Additional Stainless Steel Divider Rods – Horizontal model	each ₹1491
GRSDS-DIV	Additional Stainless Steel Divider Rods – Slant model	each 1491



SDS24FLIP Accessory. Shown with brackets for retrofit

COLORS AND FINISHES – INSIDE BACK COVER

OPTIONS

(available at time of purchase only)

Designer Colors – Non-standard colors are non-returnable – Glossy Gray Standard –

RED	Warm Red	₹25560
BLACK	Black	25560
GRAY	Gray Granite	25560
WHITE	White Granite	25560
NAVY	Navy Blue	25560
GREEN	Hunter Green	25560
COPPER	Antique Copper	25560

Glo-Ray® Designer Merchandising Warmers

Boost impulse sales by showcasing your hot foods in the Hatco Glo-Ray® Designer Merchandising Warmers. Designed specifically for displaying wrapped or boxed product, these warmers hold hot food safely at proper serving temperatures.

- Constructed of aluminum and stainless steel with tempered glass side panels
- Pre-focused infrared top heat directs heat to the outer edges where heat loss is greatest
- Available in single- or two-tier models
- Horizontal or slant shelves
- Product divider rods sort food displays
- Thermostatically-controlled hardcoated heated base extends holding times
- Shatter-resistant incandescent lights illuminate the holding areas and emphasize the product

GR2SDH-30 with optional Designer color inset panels



GR2SDS-30D in optional Designer Black



DESIGNER HORIZONTAL DISPLAY WARMERS

Model*	Bulbs	Divider Rods per Shelf	Dimensions W x D x H (Height includes legs)	Voltage Single Phase	Usable Heated Shelf Space (W x D)	Watts	Ship Weight	List Price
Single Shelf								
GR2SDH-24	2	5	768 x 686 x 459 mm	220	603 x 559 mm	800	40 kg	₹229046
GR2SDH-30	2	6	921 x 686 x 459 mm	220	759 x 559 mm	1000	55 kg	246370
GR2SDH-36	2	7	1073 x 686 x 459 mm	220	911 x 559 mm	1200	59 kg	264404
GR2SDH-42	4	8	1226 x 686 x 459 mm	220	1064 x 559 mm	1450	63 kg	292946
GR2SDH-48	4	9	1378 x 686 x 459 mm	220	1216 x 559 mm	1650	73 kg	321701
GR2SDH-54	4	10	1530 x 686 x 459 mm	220	1368 x 559 mm	1850	78 kg	350882
GR2SDH-60	6	12	1683 x 686 x 459 mm	220	1521 x 559 mm	2150	85 kg	377791
Dual Shelf								
GR2SDH-24D	4	5	768 x 686 x 737 mm	220	603 x 559 mm	1600	57 kg	₹377223
GR2SDH-30D	4	6	921 x 686 x 737 mm	220	759 x 559 mm	2000	72 kg	398878
GR2SDH-36D	4	7	1073 x 686 x 737 mm	220	911 x 559 mm	2400	93 kg	418758
GR2SDH-42D*	8	8	1226 x 686 x 737 mm	220	1064 x 559 mm	2900	102 kg	459086
GR2SDH-48D*	8	9	1378 x 686 x 737 mm	220	1216 x 559 mm	3300	115 kg	498420
GR2SDH-54D*	8	10	1530 x 686 x 737 mm	220	1368 x 559 mm	3700	124 kg	538677
GR2SDH-60D*	12	12	1683 x 686 x 737 mm	220	1521 x 559 mm	4300	149 kg	576946

All Designer Horizontal Single and Dual Shelf Models Feature:

Cord Location: Back center of base on control side.

DESIGNER SLANT DISPLAY WARMERS

Model*	Bulbs	Divider Rods per Shelf	Dimensions W x D x H (Height includes legs)	Voltage Single Phase	Usable Heated Shelf Space (W x D)	Watts	Ship Weight	List Price
Single Shelf								
GR2SDS-24	2	5	768 x 680 x 579 mm	220	603 x 559 mm	800	47 kg	₹247364
GR2SDS-30	2	6	921 x 680 x 579 mm	220	759 x 559 mm	1000	50 kg	260925
GR2SDS-36	2	7	1073 x 680 x 579 mm	220	911 x 559 mm	1200	62 kg	283645
GR2SDS-42	4	8	1226 x 680 x 579 mm	220	1064 x 559 mm	1450	70 kg	312116
GR2SDS-48	4	9	1378 x 680 x 579 mm	220	1216 x 559 mm	1650	74 kg	340090
GR2SDS-54	4	10	1530 x 680 x 579 mm	220	1368 x 559 mm	1850	83 kg	368632
GR2SDS-60	6	12	1683 x 680 x 579 mm	220	1521 x 559 mm	2150	92 kg	394760
Dual Shelf								
GR2SDS-24D	4	5	768 x 680 x 860 mm	220	603 x 559 mm	1600	74 kg	₹383968
GR2SDS-30D	4	6	921 x 680 x 860 mm	220	759 x 559 mm	2000	84 kg	410948
GR2SDS-36D	4	7	1073 x 680 x 860 mm	220	911 x 559 mm	2400	91 kg	436792
GR2SDS-42D*	8	8	1226 x 680 x 860 mm	220	1064 x 559 mm	2900	99 kg	476978
GR2SDS-48D*	8	9	1378 x 680 x 860 mm	220	1216 x 559 mm	3300	116 kg	516312
GR2SDS-54D*	8	10	1530 x 680 x 860 mm	220	1368 x 559 mm	3700	120 kg	556285
GR2SDS-60D*	12	12	1683 x 680 x 860 mm	220	1521 x 559 mm	4300	135 kg	594554

* When no color is specified, color inset panels and corner caps will be Black.

* Cord without plug.

All Designer Slant Single and Dual Shelf Models Feature:

Cord Location: Back center of base on control side.

OPTIONS AND ACCESSORIES AND MODEL DESIGNATION – PAGE 107



GR2SDS-24D with optional Designer color inset panels

Heated Merchandisers

OPTIONS (available at time of purchase only)

127 mm Sneeze Guard (Customer side only on Slant models) –

GR2SD24BP	765 mm wide models	per shelf ₹ 6958
GR2SD30BP	918 mm wide models	per shelf 8733
GR2SD36BP	1070 mm wide models	per shelf 10508
GR2SD42BP	1222 mm wide models	per shelf 12283
GR2SD48BP	1375 mm wide models	per shelf 14058
GR2SD54BP	1527 mm wide models	per shelf 15833
GR2SD60BP	1680 mm wide models	per shelf 17608

Plexi-Glass Flip-Up Doors (on Control or Customer side) –

2SDS24FLIP	765 mm wide models	per shelf ₹11502
2SDS30FLIP	918 mm wide models	per shelf 13206
2SDS36FLIP	1070 mm wide models	per shelf 14981
2SDS42FLIP	1222 mm wide models	per shelf 16827

Plexi-Glass Split Flip-Up Doors (on Control or Customer side) –

2SDS48FLIP	1375 mm wide models	per shelf ₹19880
2SDS54FLIP	1527 mm wide models	per shelf 23288
2SDS60FLIP	1680 mm wide models	per shelf 26625

2SDHFRTGLS Front Glass in lieu of Channel Dividers and Divider Rods. Cannot have Sneeze Guards or Flip-Up Doors (GR2SDH series only) **per shelf ₹ 6319**

SS-ITC Indicating Temperature Control (LED) single shelf (adds 48 mm to Horizontal model depth and 45 mm to Slant model depth) **18673**

DS-ITC Indicating Temperature Control (LED) Dual shelf (adds 48 mm to Horizontal model depth and 45 mm to Slant model depth) **32163**

ACCESSORIES

2SD-DIV Additional Stainless Steel Divider Rods **each ₹1491**

Chef LED Bulbs – 230V adjustable bulb – See page 49 for more information –

CLED-2700-230	Chef LED Bulb (similar to an incandescent warm light)	each ₹7171
CLED-3000-230	Chef LED Bulb (similar to a halogen warm)	each 7171
CLED-4000-230	Chef LED Bulb (similar to a fluorescent cool light)	each 7171

COLORS AND FINISHES – INSIDE BACK COVER

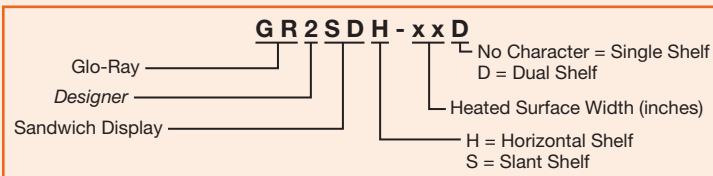

OPTIONS (available at time of purchase only)

Designer Colors – Non-standard colors are non-returnable – Clear Anodized Aluminum standard –

RED	Warm Red	₹25560
BLACK	Black	25560
GRAY	Gray Granite	25560
WHITE	White Granite	25560
NAVY	Navy Blue	25560
GREEN	Hunter Green	25560
COPPER	Antique Copper	25560

Designer Inset Panel Colors – Non-standard colors are non-returnable – Black standard –

RED	Warm Red	No Charge
GRAY	Gray Granite	No Charge
WHITE	White Granite	No Charge
NAVY	Navy Blue	No Charge
GREEN	Hunter Green	No Charge
COPPER	Antique Copper	No Charge

Designer Corner Caps – Non-standard colors are non-returnable – Black standard –

DKGRAY	Dark Gray Corner Caps	No Charge
--------	-----------------------	-----------



SS-ITC Optional



DS-ITC Optional

Heated LED Merchandisers

The new Heated Merchandiser with LED lighting is sleekly designed to safely hold hot packaged food to attract your grab-and-go customers. Available with slant or horizontal shelves, the Heated LED Merchandising Warmers are offered in both single and dual shelf models.

- Choose from slant or horizontal, single or dual shelf models
- Infrared heat safely holds hot packaged product for hours
- High efficiency LED lighting creates better illumination of food product in the holding area
- Features a thermostatically-controlled hardcoated heated base shelf
- Hinged glass side panels are held in place magnetically and swing out for easy cleaning
- An optional Indicating Temperature Control (ITC) enhances accurate control of temperature



HXMS-36D
in standard
Designer Black



Heated Merchandisers

HEATED LED MERCHANDISING WARMERS

Model	Divider Rods	Dimensions (W x D x H) <i>Height includes legs</i>	Usable Heated Shelf Space W x D	Voltage	Amps	Watts	Ship Weight*	List Price
Horizontal Single Shelf								
HXMH-24	5	709 x 725 x 555 mm	567 x 552 mm	230	2.9	671	55 kg	₹247080
HXMH-30	6	861 x 725 x 555 mm	720 x 552 mm	230	3.8	863	60 kg	264404
HXMH-36	7	1013 x 725 x 555 mm	872 x 552 mm	230	4.6	1055	66 kg	281941
HXMH-42	8	1166 x 725 x 555 mm	1025 x 552 mm	230	5.2	1201	73 kg	310554
HXMH-48	9	1318 x 725 x 555 mm	1177 x 552 mm	230	6.1	1392	86 kg	338954
HXMH-54	10	1471 x 725 x 555 mm	1329 x 552 mm	230	6.9	1585	91 kg	367425
HXMH-60	12	1623 x 725 x 555 mm	1482 x 552 mm	230	7.7	1777	94 kg	393553
Horizontal Dual Shelf								
HXMH-24D	10	709 x 725 x 835 mm	567 x 552 mm	230	5.8	1342	73 kg	₹397955
HXMH-30D	12	861 x 725 x 835 mm	720 x 552 mm	230	7.5	1726	84 kg	425077
HXMH-36D	14	1013 x 725 x 835 mm	872 x 552 mm	230	9.2	2110	93 kg	444318
HXMH-42D	16	1166 x 725 x 835 mm	1025 x 552 mm	230	10.4	2402	100 kg	484149
HXMH-48D	18	1318 x 725 x 835 mm	1177 x 552 mm	230	12.1	2784	111 kg	522915
HXMH-54D*	20	1471 x 725 x 835 mm	1329 x 552 mm	230	13.8	3170	123 kg	562107
HXMH-60D*	24	1623 x 725 x 835 mm	1482 x 552 mm	230	15.5	3554	136 kg	598743

HEATED LED MERCHANDISING WARMERS

Model	Divider Rods	Dimensions (W x D x H) <i>Height includes legs</i>	Usable Heated Shelf Space W x D	Voltage	Amps	Watts	Ship Weight*	List Price
Slant Single Shelf								
HXMS-24	5	709 x 715 x 551 mm	567 x 552 mm	230	2.9	671	51 kg	₹256807
HXMS-30	6	861 x 715 x 551 mm	720 x 552 mm	230	3.8	863	60 kg	270652
HXMS-36	7	1013 x 715 x 551 mm	872 x 552 mm	230	4.6	1055	68 kg	293798
HXMS-42	8	1166 x 715 x 551 mm	1025 x 552 mm	230	5.2	1201	73 kg	322766
HXMS-48	9	1318 x 715 x 551 mm	1177 x 552 mm	230	6.1	1392	85 kg	351237
HXMS-54	10	1471 x 715 x 551 mm	1329 x 552 mm	230	6.9	1585	93 kg	380489
HXMS-60	12	1623 x 715 x 551 mm	1482 x 552 mm	230	7.7	1777	93 kg	407185
Slant Dual Shelf								
HXMS-24D	10	709 x 715 x 831 mm	567 x 552 mm	230	5.8	1342	73 kg	₹397955
HXMS-30D	12	861 x 715 x 831 mm	720 x 552 mm	230	7.5	1726	85 kg	425077
HXMS-36D	14	1013 x 715 x 831 mm	872 x 552 mm	230	9.2	2110	94 kg	450211
HXMS-42D	16	1166 x 715 x 831 mm	1025 x 552 mm	230	10.4	2402	105 kg	491178
HXMS-48D	18	1318 x 715 x 831 mm	1177 x 552 mm	230	12.1	2784	111 kg	531364
HXMS-54D*	20	1471 x 715 x 831 mm	1329 x 552 mm	230	13.8	3170	123 kg	572118
HXMS-60D*	24	1623 x 715 x 831 mm	1482 x 552 mm	230	15.5	3554	132 kg	611026

* Shipping weights are approximate.

* Cord without plug.

All Heated LED Merchandising Warmer Models Feature:
Cord Location: Back center of base, on left side of control box.

OPTIONS AND ACCESSORIES – PAGE 109

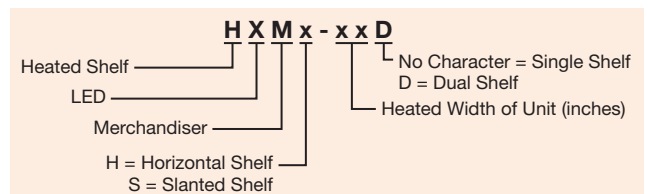



Heated Merchandisers

HXMS-48D in standard *Designer Black* with optional LED accent lighting in support posts

OPTIONS (available at time of purchase only)

Designer Colors – Non-standard colors are non-returnable – Black standard –

RED	Warm Red	₹25560
GRAY	Gray Granite	25560
WHITE	White Granite	25560
NAVY	Navy Blue	25560
GREEN	Hunter Green	25560
COPPER	Antique Copper	25560

HZM-LP	Red LED Accent Lighting in support post	₹36849
SS-ITC	Indicating Temperature Control (LED) for single shelf	18673
DS-ITC	Indicating Temperature Control (LED) for dual shelf	32163

127 mm Sneeze Guards – Not compatible with Flip-Up Doors in same opening –

HZM24BP	On Customer side on -24 models	per shelf ₹13490
HZM30BP	On Customer side on -30 models	per shelf 14697
HZM36BP	On Customer side on -36 models	per shelf 15904
HZM42BP	On Customer side on -42 models	per shelf 17466
HZM48BP	On Customer side on -48 models	per shelf 19028
HZM54BP	On Customer side on -54 models	per shelf 20803
HZM60BP	On Customer side on -60 models	per shelf 22578

Plexi-Glass Flip-Up Doors – Not compatible with Sneeze Guards in same opening, one side only –

HZM24FLIP	On Control or Customer side on -24 models	per shelf ₹13632
HZM30FLIP	On Control or Customer side on -30 models	per shelf 14768
HZM36FLIP	On Control or Customer side on -36 models	per shelf 15975
HZM42FLIP	On Control or Customer side on -42 models	per shelf 17466
HZM48FLIP	On Control or Customer side on -48 models	per shelf 19099
HZM54FLIP	On Control or Customer side on -54 models	per shelf 20874
HZM60FLIP	On Control or Customer side on -60 models	per shelf 22720

ACCESSORIES

HZM-DIV	Additional Stainless Steel Divider Rods	each ₹1491
----------------	---	------------

COLORS AND FINISHES – INSIDE BACK COVER

Glo-Ray® Heated Glass Merchandisers

Hatco's Glo-Ray® Heated Glass Merchandisers are perfect for holding hot wrapped or boxed foods on a buffet line or customer serving areas, and features a curved top design that compliments any décor.

- Blanket-style heating elements in the hardcoated base that are thermostatically-controlled
- Unique, patented heated glass shelves with infinite controls conduct heat to food product above and below
- LED lighting allows for optimal food product display with energy savings
- Attractive curved top design includes a built-in front sign holder (sign not included)
- Also comes with: tempered glass side panels, 2.5" (64 mm) legs, thermostatically-controlled heated base and upper canopy, divider rods and comes standard in *Designer Black*



GR3SDS-39DCT in standard *Designer Black* and top sign holder (sign not included)



GR3SDS-39TCT in standard *Designer Black* and top sign holder (sign not included)

Heated Merchandisers

HEATED GLASS MERCHANDISERS

Model	Dimensions W x D x H	Usable Heated Shelf Space (W x D)	Voltage Single Phase	Watts	Amps	Ship Weight	List Price
Dual Shelf GR3SDS-39DCT	995 x 698 x 673 mm	895 x 540 mm	230	1910	8.3	84 kg	₹513188
Triple Shelf GR3SDS-39TCT *	995 x 698 x 882 mm	895 x 540 mm	230	2970	12.9	104 kg	₹675636

* Cord without plug.

All Heated Glass Merchandiser Models Feature:

Divider Rods Included : GR3SDS-39DCT : 14 rods (7 per shelf).

GR3SDS-39TCT : 21 rods (7 per shelf).

Cord Location : Right rear on server side.

OPTIONS (available at time of purchase only)

Designer Colors – Non-standard colors are non-returnable – Black standard –

RED	Warm Red	No Charge
GRAY	Gray Granite	No Charge
WHITE	White Granite	No Charge
NAVY	Navy Blue	No Charge
GREEN	Hunter Green	No Charge
COPPER	Antique Copper	No Charge

Gloss Finish – Non-standard colors are non-returnable – Black standard –

GGRAY	Glossy Gray	No Charge
--------------	-------------	------------------

Panted Shelf Sign Holders – (Signs not included) – Color matches unit color

– in lieu of Box Stops and Divider Rods –

3SDCT39SIGN	39 width model. Requires 991W x 48H x 1D mm sign	each ₹6177
--------------------	--	------------

ACCESSORIES (available for purchase at any time)

4"LEGS	102 mm Adjustable Legs	Set of 4 ₹3337
3SD-DIV	Additional Stainless Steel Divider Rods (not compatible with optional Shelf Sign Holders)	each 1491

COLORS AND FINISHES – INSIDE BACK COVER

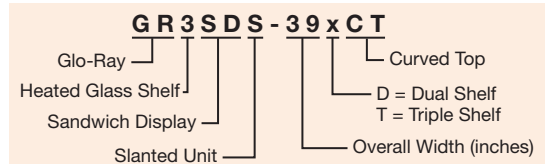

Glo-Ray® Curved Merchandising Warmers

Looking to add a touch of class to a new point-of-sale area or to change or upgrade an existing area? Hatco's Glo-Ray® Curved Merchandising Warmer offers a unique and attractive solution for impulse sales areas.

- Single shelf and dual shelf units come standard with mirrored glass back panel
- Individual thermostatically-controlled heated base with master rocker switch maintains safe-serving temperatures
- Incandescent lighting allows for optimal food product display
- Humidified dual shelf unit contains a 1.2 liter capacity water reservoir
- Models with Simulated Stone are Swanstone®



GRCMW-1 in Designer Black with food pans (not available)



GRCMW-1DH in Designer Black with food pans (not available)

Heated Merchandisers

CURVED MERCHANDISING WARMERS

Model	Dimensions W x D x H	Voltage Single Phase	Usable Heated Shelf Space (W x D)		Watts	Ship Weight	List Price
			Top Shelf	Bottom Shelf			
Single Shelf							
GRCMW-1	562 x 546 x 505 mm	220	—	501 x 330 mm	619	25 kg	₹186375
Dual Shelf							
GRCMW-1D	660 x 511 x 683 mm	220	577 x 314 mm	577 x 396 mm	1294	42 kg	₹353793
Dual Shelf with Humidity							
GRCMW-1DH*	660 x 511 x 683 mm	220	577 x 314 mm	577 x 396 mm	1395	45 kg	₹378288

* Humidity on bottom shelf only.

All Models Feature:

Water Reservoir Capacity (GRCMW-1DH model only): 1.2 liters.

Cord Location: Control side at right base corner.

WATER QUALITY REQUIREMENTS – PAGE 145

OPTIONS (available at time of purchase only)

Designer Colors (unit's painted surface) – Non-standard colors are non-returnable – Black standard –

RED	Warm Red	No Charge
GRAY	Gray Granite	No Charge
WHITE	White Granite	No Charge
NAVY	Navy Blue	No Charge
GREEN	Hunter Green	No Charge
COPPER	Antique Copper	No Charge

Simulated Stone Color (Unit's painted surface and decorative trim inserts)

– Non-standard colors are non-returnable –

GGRAN	Gray Granite	₹ 32021
NSKY	Night Sky	32021
BSAND	Bermuda Sand	32021

CMWDBACKFLIP	Top and bottom shelf Flip-Up Doors on Server's side in lieu of Mirrored Back Panel (GRCMW-1D, -1DH models only)	₹21442
---------------------	---	--------

CMWDTOPFLIP	Top shelf Flip-Up Door on Customer side in lieu of Sneeze Guard (GRCMW-1D, -1DH models only)	10792
--------------------	--	-------

FOOD PANS AND TRIVETS – PAGE 143

COLORS AND FINISHES – INSIDE BACK COVER

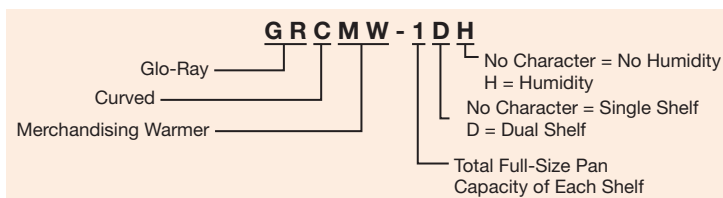

Glo-Ray® Designer Heated Display Cases

Our Designer series Glo-Ray® Heated Display Case with curved glass and incandescent lighting will display your offering with flare and elegance. We combine our thermostatically-controlled heated base and infrared overhead heating to blanket your offering at the perfect temperature.

- High visibility merchandiser with curved tempered glass
- Exclusive cool base construction
- Single or Dual models
- Rollerless sliding doors
- Available with or without controlled humidity (bottom shelf only)
- Constructed of aluminum and stainless steel with tempered glass
- Curved glass front tilts forward for easy cleaning
- Pre-focused infrared top heat directs heat to the outer edges where heat loss is greatest
- Shatter-resistant incandescent lights illuminate the food product



GRCO-2PD with optional pan skirt and Designer color, flip-up doors, and accessory food pans



GRCDH-1PD with pan skirt and new optional flip-up doors and accessory food pan (top baking dish not available)



Humidified reservoir is located in between pans



GRCDH-3PD shown in standard Stainless Steel, with accessory food pans

Heated Merchandisers

DESIGNER DISPLAY CASES

Model	Bulbs	Dimensions W x D x H (Height includes legs)	Usable heated Shelf Space (W x D)	Voltage Single Phase	Watts	Ship Weight	List Price
Single Shelf							
GRCO-1P	2	524 x 660 x 610 mm	460 x 533 mm	220	405	43 kg	₹294224
GRCO-2P	3	826 x 660 x 610 mm	762 x 533 mm	220	710	55 kg	335901
GRCO-3P	3	1156 x 660 x 610 mm	1092 x 533 mm	220	915	69 kg	377649
Dual Shelf							
GRCO-1PD	4	524 x 660 x 806 mm	460 x 533 mm	220	907	45 kg	₹343498
GRCO-2PD	6	826 x 660 x 806 mm	762 x 533 mm	220	1080	77 kg	391068
GRCO-3PD	6	1156 x 660 x 806 mm	1092 x 533 mm	220	1437	95 kg	450424
Single Shelf with Humidity*							
GRCDH-1P	2	524 x 660 x 610 mm	460 x 533 mm	220	634	41 kg	₹335972
GRCDH-2P	3	826 x 660 x 610 mm	762 x 533 mm	220	939	56 kg	377720
GRCDH-3P	3	1156 x 660 x 610 mm	1092 x 533 mm	220	1145	71 kg	419468
Dual Shelf with Humidity*							
GRCDH-1PD	4	524 x 660 x 806 mm	460 x 533 mm	220	1136	55 kg	₹385175
GRCDH-2PD	6	826 x 660 x 806 mm	762 x 533 mm	220	1309	79 kg	432887
GRCDH-3PD	6	1156 x 660 x 806 mm	1092 x 533 mm	220	1666	100 kg	492243

* Humidity on bottom shelf only. Includes pan skirt on bottom shelf. Pan skirts accommodate 64 H mm pans.

All Models Feature:

Cord Location: Control side at right base corner.

All Models With Humidity Feature:

Water Chamber Capacity: 3 liters.

WATER QUALITY REQUIREMENTS – PAGE 145
OPTIONS AND ACCESSORIES – PAGE 114

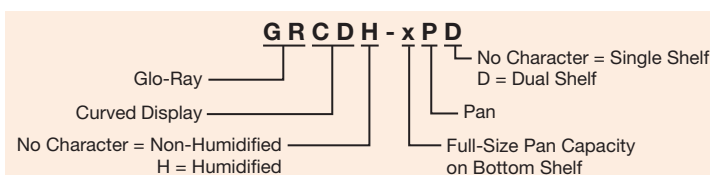



GRCD-2PD with optional flip-up doors and *Designer* color

OPTIONS (available at time of purchase only)

Self-Closing Flip-Up Doors on both shelves on Customer side in lieu of Glass Front (adds 13 mm depth to unit) –

CD1PDFLIP	1-Pan models	₹46150
CD2PDFLIP	2-Pan models	49487
CD3PDFLIP	3-Pan models	87259

Pan Skirt on Bottom Shelf (Accommodates 64 D mm pans – standard on Humidified models) –

SKIRT-1P	1-Pan model in lieu of Pan Rail	₹3124
SKIRT-2P	2-Pan model in lieu of Pan Rail	5680
SKIRT-3P	3-Pan model in lieu of Pan Rail	8236

UPPERSKIRT-2P	Pan Skirt for upper shelf of 2-Pan models in lieu of Pan Stop	₹ 5822
UPPERSKIRT-3P	Pan Skirt for upper shelf of 3-Pan models in lieu of Pan Stop	11644

Mirrored Glass Sliding Doors in lieu of Glass Doors (Server side only) –

Single Shelf Models –

MIRROR	-1P	₹5041
MIRROR	-2P	6958
MIRROR	-3P	8875

Dual Shelf Models –

MIRROR	-1PD	₹10082
MIRROR	-2PD	13916
MIRROR	-3PD	17750

OPTIONS

(available at time of purchase only)

Designer Colors – Non-standard colors are non-returnable – Stainless Steel standard –

RED	Warm Red	₹25560
BLACK	Black	25560
GRAY	Gray Granite	25560
WHITE	White Granite	25560
NAVY	Navy Blue	25560
GREEN	Hunter Green	25560
COPPER	Antique Copper	25560

HEATED DISPLAY CASE MAXIMUM PAN CAPACITIES*

Model	Pan Capacity	Optional Pan Skirt Frames
GRCD-1P	1 Full-Size Pan	One SKIRT-1P
GRCD-2P	2 Full-Size Pans	One SKIRT-2P
GRCD-3P	3 Full-Size Pans	One SKIRT-3P
GRCD-1PD – Top Shelf	1 Half-Size Pan or one 356 mm Pizza Pan	None
GRCD-1PD – Bottom Shelf	1 Full-Size Pan	One SKIRT-1P
GRCD-2PD – Top Shelf	1 Full-Size Pan and 1 Third-Size Pan or two 356 mm Pizza Pans	One UPPERSKIRT-2P
GRCD-2PD – Bottom Shelf	2 Full-Size Pans	One SKIRT-2P
GRCD-3PD – Top Shelf	2 Full-Size Pans or three 356 mm Pizza Pans	One UPPERSKIRT-3P
GRCD-3PD – Bottom Shelf	3 Full-Size Pans	One SKIRT-3P

* All pan capacities shown are for non-humidified models. 64 mm deep pans recommended for bottom shelf of humidified models.

FOOD PANS AND TRIVETS – PAGE 143

COLORS AND FINISHES – INSIDE BACK COVER

Glo-Ray® Heated Display Cases

Designed for “show and sell” area in any foodservice operation, the Hatco Glo-Ray® Heated Display is perfect for hot food merchandising. Top and bottom heat combine to keep all food at that “just-made” taste and temperature longer.

- Thermostatically-controlled heated base 38° - 93°C to extend holding times
- Pre-focused infrared top heat directs heat to the outer edges where heat loss is greatest
- Constructed of aluminum and stainless steel with tempered glass
- Shatter-resistant incandescent lights illuminate the food product
- Exclusive cool base construction minimizes heat transfer, keeping exterior base cool
- Rollerless sliding doors



GRHD-4PD with optional *Designer* color, mirrored glass doors and accessory food pans



GRHDH-2P with standard pan skirt and optional double side opening, and accessory food pans

Heated Merchandisers

DISPLAY CASES

Model*	Bulbs	Dimensions (W x D x H) Height includes legs	Usable Heated Shelf Space (W x D)	Voltage Single Phase	Watt	Ship Weight	List Price
Single Shelf							
GRHD-2P	4	826 x 660 x 635 mm	712 x 553 mm	220	1035	54 kg	₹250985
GRHD-3P	5	1156 x 660 x 635 mm	1042 x 553 mm	220	1465	65 kg	286698
GRHD-4P	6	1486 x 660 x 635 mm	1372 x 553 mm	220	1930	98 kg	338102
Dual Shelf							
GRHD-2PD	6	826 x 660 x 762 mm	712 x 553 mm	220	1223	68 kg	₹344563
GRHD-3PD	8	1156 x 660 x 762 mm	1042 x 553 mm	220	1603	86 kg	386808
GRHD-4PD	8	1486 x 660 x 762 mm	1372 x 553 mm	220	2288	104 kg	444105
Single Shelf with Humidity*							
GRHDH-2P	4	826 x 660 x 635 mm	712 x 553 mm	220	1179	57 kg	₹293159
GRHDH-3P	5	1156 x 660 x 635 mm	1042 x 553 mm	220	1584	74 kg	328801
GRHDH-4P	6	1486 x 660 x 635 mm	1372 x 553 mm	220	2253	98 kg	410238
Dual Shelf with Humidity*							
GRHDH-2PD	6	826 x 660 x 762 mm	712 x 553 mm	220	1532	80 kg	₹386737
GRHDH-3PD	8	1156 x 660 x 762 mm	1042 x 553 mm	220	1962	85 kg	428911
GRHDH-4PD	8	1486 x 660 x 762 mm	1372 x 553 mm	220	2941	109 kg	516241

* Model number indicates the number of full-size food pans the unit will hold, with same number of half-size pans for units with a top shelf (i.e., 2P = two pans).

* Humidity on bottom shelf only. Includes pan skirt on bottom shelf. Pan skirts accommodate 64 mm pans.

All Models Feature:

Water Reservoir Capacity : 2-Pan and 3-Pan : 3 liters.
4-Pan: 6 liters.

Cord Location: 1829 mm, control side at right base corner.

WATER QUALITY REQUIREMENTS – PAGE 145

OPTIONS AND ACCESSORIES – PAGE 116

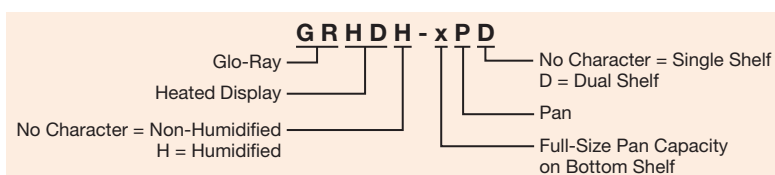



GRHD-4PD with optional pan skirts
 Top shelf: one UPPERSKIRT-4P
 Bottom shelf: one SKIRT-4P

OPTIONS (available at time of purchase only)

SKIRT-2P	2-Pan model Pan Skirt for 64 D mm Pans on bottom shelf (standard on Humidified models) in lieu of Pan Rail	₹ 5822
SKIRT-3P	3-Pan model Pan Skirt for 64 D mm Pans on Bottom Shelf (standard on Humidified models) in lieu of Pan Rail (consists of one SKIRT-1P and one SKIRT-2P)	8236
SKIRT-4P	4-Pan model Pan Skirt for 64 D mm Pans on bottom shelf (standard on Humidified models) in lieu of Pan Rail (consists of two SKIRT-2P)	11644
UPPERSKIRT-2P	Pan Skirt for upper shelf of 2-Pan models in lieu of Pan Stop	5822
UPPERSKIRT-3P	Pan Skirt for upper shelf of 3-Pan models in lieu of Pan Stop	11644
UPPERSKIRT-4P	Pan Skirt for upper shelf of 4-Pan models in lieu of Pan Stop	11644
FLIP	Flip-up Doors on Control side in lieu of Glass Sliding Doors	No Charge
Sliding Door in lieu of Fixed Glass Customer Panel –		
SLIDE-2P	Per opening	₹12141
SLIDE-3P	Per opening	13348
SLIDE-4P	Per opening	16685
Flip-Up Door in lieu of Fixed Glass Customer Panel –		
FLIP-2P	Per opening	₹12141
FLIP-3P	Per opening	13348
FLIP-4P	Per opening	16685
Mirror Glass Sliding Door in lieu of Glass Sliding Door (server side only) –		
MIRROR-2P	Per opening	₹ 6958
MIRROR-3P	Per opening	8875
MIRROR-4P	Per opening	10934

OPTIONS

(available at time of purchase only)

Designer Colors – Non-standard colors are non-returnable

– **Stainless Steel standard –**

RED	Warm Red	₹25560
BLACK	Black	25560
GRAY	Gray Granite	25560
WHITE	White Granite	25560
NAVY	Navy Blue	25560
GREEN	Hunter Green	25560
COPPER	Antique Copper	25560

FOOD PANS AND TRIVETS – PAGE 143

COLORS AND FINISHES – INSIDE BACK COVER

HEATED DISPLAY CASE MAXIMUM PAN CAPACITIES*

Model	Pan Capacity	Optional Pan Skirt Frames
GRHD-2P	2 Full-Size Pans	One SKIRT-2P
GRHD-3P	3 Full-Size Pans	One SKIRT-3P
GRHD-4P	4 Full-Size Pans	One SKIRT-4P
GRHD-2PD – Top Shelf	2 Half-Size Pans or two 356 mm Pizza Pans	One UPPERSKIRT-2P
GRHD-2PD – Bottom Shelf	2 Full-Size Pans	One SKIRT-2P
GRHD-3PD – Top Shelf	3 Half-Size Pans or three 356 mm Pizza Pans	One UPPERSKIRT-3P
GRHD-3PD – Bottom Shelf	3 Full-Size Pans	One SKIRT-3P
GRHD-4PD – Top Shelf	2 Full-Size Pans or 4 Half-Size Pans or four 356 mm Pizza Pans	One UPPERSKIRT-4P
GRHD-4PD – Bottom Shelf	4 Full-Size Pans	One SKIRT-4P

* All pan capacities shown are for non-humidified models. 64 mm deep pans recommended for bottom shelf of humidified models.

Holding & Display Cabinets

Cafeterias • Convenience Stores
Catering • Concessions



PWC-12 pg. 118



FDWDE-1X pg. 119



FSDT-2X with accessory 5-shelf angle rack and sign holder (signs not included) pg. 120



IHDCH-45 with accessory risers and sign holders pg. 124



MDW-1X with standard *Designer* color and optional hood with backlit sign cutout on one side (sign included) pg. 126



FSHC-7W1-EE shown in *Designer Black*, with optional right-hand hinged door pg. 127



FSHC-6W1 with accessory food pans pg. 128



FS2HAC-2PT pass-through with accessory food pans pg. 130

Plate Warmers

Hatco's Plate Warmers are designed to hold preheated serving plates where your customers can access them easily. Countertop or Built-In models available. Easy to load and easy to clean. Serving hot food on preheated plates will help extend the holding times of most foods, and adds to a better customer experience.

- Can hold 25 plates up to 305 mm in diameter
- A covered, digital temperature control with an adjustable range of 40° - 50°C
- Energy efficient LED lighting illuminates the interior from the top
- Optional *Designer Black* Powdercoating
- Cabinet cutout dimensions are: 423 x 512 mm



PWC-12

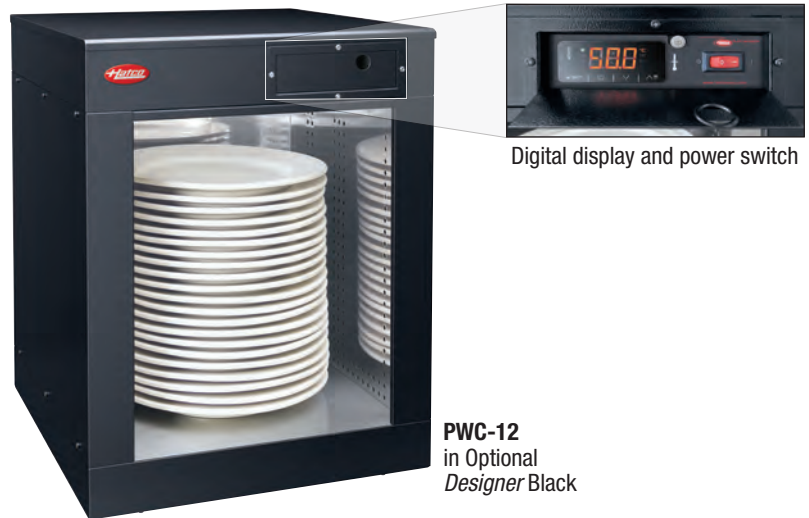

Digital display and power switch

PWC-12 in Optional *Designer Black*

Holding & Display Cabinets

PLATE WARMERS

Model	Dimensions (W x D x H)	Opening Dimensions (W x H)	Voltage	Watts	Amps	Ship Weight	List Price
Counter Top							
PWC-12	427 x 441 x 566 mm	320 x 400 mm	220-240	389-463	1.7-1.8-1.9	29 kg	₹81366
Built-In							
PWB-12	444 x 442 x 534 mm	322 x 400 mm	220-240	389-463	1.7-1.8-1.9	22 kg	₹75331

All Plate Warmer Models Feature:

Models Shipped with:

PWC-12: Power On/Off switch, a detachable 1829 mm power cord, a 1000 mm jumper cord and a wall-mounting kit.

PWB-12: Power On/Off switch, a detachable 1829 mm power cord and a 1000 mm jumper cord.

Cabinet cut-out dimensions for PWB-12: 423W x 512H mm.

Cord Location: back of unit, top left corner.

OPTIONS (available at time of purchase only)

Color – Non-standard colors are non-returnable – Stainless Steel Standard – BLACK

Designer Black

₹8236

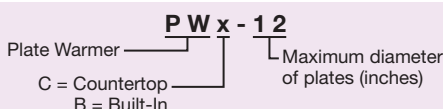



Flav-R-Fresh® Impulse Display Cabinets

A profitable way to create impulse food sales is with the small Flav-R-Fresh® Holding and Display Cabinet. Using separate heat and humidity controls to keep crisp foods crisp and moist foods moist allows you to showcase your products longer using minimum counter space.

- Full-view display with tempered glass sides and door
- LED light enhances food appeal while safeguarding food products from bulb breakage
- Internal thermometer indicates cabinet temperature
- Single- or double-door opening models provide fast access to food racks
- Food decals and merchandising signs are available to help promote product visibility and appeal



FDWDE-1 with rotating 4-tier rack and accessory pans

IMPULSE DISPLAY CABINETS

Model*	Description°	Dimensions W x D x H <i>Height includes standard 25 mm legs</i>	Voltage Single Phase	Ship Weight	List Price [°]
FDWDE-1	1 Door w/Circle Rack w/Motor	492 x 530 x 726 mm	220	38 kg	₹193688
FDWDE-1X	1 Door w/Multi-Purpose Rack	492 x 530 x 726 mm	220	38 kg	187724
FDWDE-2	2 Doors w/Circle Rack w/Motor	492 x 559 x 726 mm	220	40 kg	203486
FDWDE-2X	2 Doors w/Multi-Purpose Rack	492 x 559 x 726 mm	220	40 kg	196102

* Models FDWDE-1 and FDWDE-2 include rack motor. Models with "X" designator do not have revolving display and are NOT available for retrofit.

° For non-humidified cabinet, deduct **₹14910**. Unit will only operate in dry mode.

° Rack listed is included with unit. Other racks available – deduct price of included rack and add price of substituted rack to list price.

All Impulse Cabinet Models Feature:

Cabinet Opening Dimensions: 400 W x 502 H mm.

Door Hinges: Control Side: Left-hand side.

Customer Side (Two-door models only): Right-hand side.

Max. Pizza Pan Size: 381 mm diameter.

Water Tank Capacity for Humidity System: 2 liters.

Cord Location: Facing controls, left-hand side panel, lower right corner.

WATER QUALITY REQUIREMENTS – PAGE 145

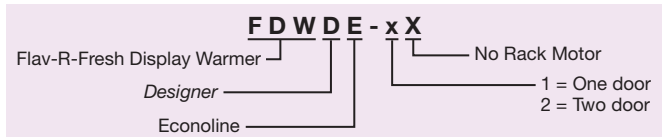

Holding & Display Cabinets

OPTIONS (available at time of purchase only)

Designer Colors – Non-standard colors are non-returnable – Clear Anodized Aluminum Standard –

RED	Warm Red	₹23998
BLACK	Black	23998
GRAY	Gray Granite	23998
WHITE	White Granite	23998
NAVY	Navy Blue	23998
GREEN	Hunter Green	23998
COPPER	Antique Copper	23998
FDWD-6FRIT	152 mm Merchandising Display Sign Holder for Control side only (includes Metal Holder only). Available in all Designer Colors to match your unit (Black is standard). Adds 29 mm to height of unit. Requires (1) Sign 491 W x 157 H x 2 D mm – not included	₹5964
FDWD-6SIGN	162 mm, One Sided Merchandising Display Sign Holder (Includes metal holder and window) – one per side , three maximum. Available in all Designer colors to match your unit (Black is Standard). Adds 32 mm to height of unit. Requires (1) sign 491 W x 159 H x 1.59 D mm – not included	4544
FDWD-DIS	76 mm One-Sided Merchandising Display Sign Holder (includes Metal Holder and Window) – one per side , three maximum. Available in all Designer colors to match your unit (Black is standard) Adds 32 mm to height of unit. Requires (1) one Sign 484 W x 83 H x 2 D mm – not included	4118

ACCESSORIES

FDWD-LEGS	102 mm Adjustable Legs (102-127 mm)	₹ 4899
COUPLING	Motorless Rack Coupling for FDWDE-1X and -2X models (select Circle Rack or Pretzel Tree)	2556
FDWD4TCRR	4-Tier Circle Rack with Pizza Pan Retainers (Requires Coupling for -1X or -2X models)	14342
FDWSMP	4-Shelf Multi-Purpose Rack (each shelf 346 W x 321 D mm)	16188
FDW3TPT	3-Tier Pretzel Tree (requires Coupling for -1X or -2X models)	16188

RACKS – PAGE 123

FOOD PANS AND TRIVETS – PAGE 143

COLORS AND FINISHES – INSIDE BACK COVER



COUPLING
Accessory

Flav-R-Savor® Holding & Display Cabinets

Balancing a precise combination of heat and humidity, the Hatco Flav-R-Savor® Cabinets provide an attractive showcase for hot food displays and generate impulse sales. A complete range of cabinet sizes, door options and rack types allows for perfect merchandising of food products such as pizza, fried foods, bakery items, sandwiches and more.

- Full-view display with tempered glass sides and door provide maximum heat retention
- Controlled heat and humidity for longer holding times
- 3-liter stainless steel water reservoir provides all day moisture
- Low-water protection prevents heating element burnout and alerts operator to low-water condition
- Revolving or stationary display racks
- Available in two heights with single- or double-sided opening models
- LED lights with clear plastic cover help showcase food product



FSD-2X with 3-tier pan rack and accessory food pans



FSDT-2 with 4-tier circle rack and 102 mm legs, optional Designer Black color and accessory food pans

DISPLAY CABINETS

Model*	Description°	Dimensions W x D x H	Cabinet Opening W x H	Voltage Single Phase	Watts	Ship Weight	List Price ^o 220, 240V
Standard							
FSD-1	1 Door w/3-Tier Circle Rack	569 x 612 x 699 mm	483 x 473 mm	220	1414	50 kg	₹297419
FSD-1X	1 Door w/3-Tier Pan Rack	569 x 612 x 699 mm	483 x 473 mm	220	1414	50 kg	288686
FSD-2	2 Doors w/3-Tier Circle Rack	569 x 642 x 699 mm	483 x 473 mm	220	1414	52 kg	317157
FSD-2X	2 Doors w/3-Tier Pan Rack	569 x 642 x 699 mm	483 x 473 mm	220	1414	51 kg	308495
Tall							
FSDT-1	1 Door w/4-Tier Circle Rack	569 x 612 x 826 mm	483 x 603 mm	220	1414	54 kg	₹302318
FSDT-1X	1 Door w/4-Tier Pan Rack	569 x 612 x 826 mm	483 x 603 mm	220	1414	54 kg	290674
FSDT-2	2 Doors w/4-Tier Circle Rack	569 x 642 x 826 mm	483 x 603 mm	220	1414	55 kg	325677
FSDT-2X	2 Doors w/4-Tier Pan Rack	569 x 642 x 826 mm	483 x 603 mm	220	1414	52 kg	314175

* Models FSD-1, FSD-2, FSDT-1 and FSDT-2 include rack motor. Models with "X" designator do not have revolving display and are NOT available for retrofit.

° Rack listed is included with unit. Other racks available – deduct price of included rack and add price of substituted rack to list price.

° For non-humidified cabinet, deduct ₹14910. Unit will only operate in dry mode.

All Display Cabinet Models Feature:

Door Hinges: Control Side: Left-hand side.

Customer Side (Two-Door models only): Right-hand side.

Max. Pan Size: 483 mm diameter.

Water Tank Capacity for Humidity System: 3 liters.

Cord Location: 1829 mm. Facing controls, left-hand side panel, lower right corner.

WATER QUALITY REQUIREMENTS – PAGE 145

OPTIONS AND ACCESSORIES – PAGE 121

FSDT - x X

Flav-R-Savor Display Cabinet
 No Character = Standard
 T = Tall
 No Rack Motor
 1 = One Door
 2 = Two Door

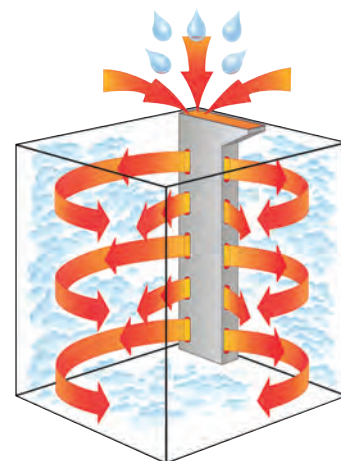

CONTROLLED MOISTURIZED HEAT KEEPS HOT FOODS FRESH LONGER

Hatco's Flav-R-Savor® air flow pattern is designed to maintain consistent cabinet temperature without drying out foods. The precise combination of heat and humidity creates a "blanket" effect around the food. The air flow rate enables the cabinet to recover temperature rapidly after opening and closing the door.



Two FSDT-1 with 4-tier circle racks, optional sign holders (signs not included) and accessory pans

OPTIONS (available at time of purchase only)

THERM	Mechanical Controls	No Charge
FSD7SIGN	191 mm Merchandising Display Sign Holder (includes Metal Holder and Window) – one per side, three maximum. Available in all <i>Designer Colors</i> to match your unit (Black is standard). Adds 32 mm to height of unit. Requires (1) Sign 572 W x 191 H x 2 D – Sign not included	₹5112

ACCESSORIES

F-LEGS-4	102 mm Adjustable Legs	₹4686
COUPLING	Motorless Rack Coupling for FSD-1X, FSD-2X, FSDT-1X and FSDT-2X models (select appropriate Circle Rack)	2556
RACK – FSD ONLY –		
FSD5SMP	5-Shelf Multi-Purpose Rack (each shelf W 457 x 406 D mm)	₹21371
FSD3TCR	3-Tier Circle Rack with Pizza Pan Retainers (requires Coupling for -1X or -2X models)	13064
FSD3TPR	3-Tier Pan Rack accommodates Half-Size Sheet Pans - not included)	18957
RACKS – FSDT ONLY –		
FSDT7SMP	7-Shelf Multi-Purpose Rack (each shelf 457 W x 406 D mm)	₹26199
FSDT4TCR	4-Tier Circle Rack with Pizza Pan Retainers (requires Coupling for -1X or -2X models)	13916
FSDT5TCR	5-Tier Circle Rack with Pizza Pan Retainers (requires Coupling for -1X or -2X models)	21158
FSDT4TPR	4-Tier Pan Rack (Accommodates Half-Size Sheet Pans - not included)	16685
FSDT3SAR	3-Shelf Angle Rack (15° angle shelves), Each shelf 457 W x 413 D mm	48209
FSDT3TPT	3-Tier Pretzel Tree (requires Coupling for -1X or -2X models)	22791

DECORATIVE KIT – PAGE 122

RACKS – PAGE 123

FOOD PANS AND TRIVETS – PAGE 143

COLORS AND FINISHES – INSIDE BACK COVER

OPTIONS

(available at time of purchase only)

Designer Colors – Non-standard colors are non-returnable – Clear Anodized Aluminum Standard –

RED	Warm Red	₹25560
BLACK	Black	25560
GRAY	Gray Granite	25560
WHITE	White Granite	25560
NAVY	Navy Blue	25560
GREEN	Hunter Green	25560
COPPER	Antique Copper	25560

Decorative Kit for FSD and FSDT Models only

Your Hatco Flav-R-Savor® Holding & Display Cabinet can transform from a "heated box" into a Designer Merchandiser with a variety of simple accessory additions. Create a new look and feel to your décor.

- The curved hinged header allows easy access to controls and water fill cup, and gives a great area to brand your food product with a magnetic sign (sign not included)
- All decorative pieces come standard in Designer Black powdercoat, with additional Designer colors available
- Curved inset panels enhance the overall look
- The base skirt completes the transformation and gives an additional branding area. Available in flat or curved panels for front and/or back of unit
- Signs not included

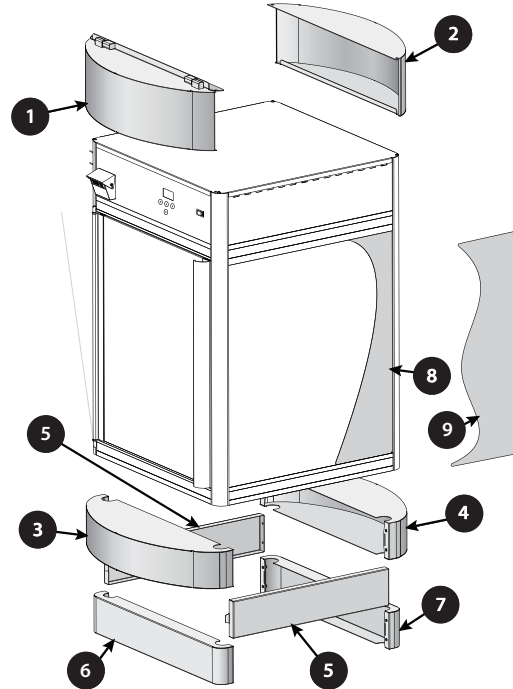

OPTIONS (available at time of purchase only)

Designer Colors – Non-standard colors are non-returnable – Black standard –

RED	WR	Warm Red	No Charge
GRAY	GG	Gray Granite	No Charge
WHITE	WG	White Granite	No Charge
NAVY	NB	Navy Blue	No Charge
GREEN	HG	Hunter Green	No Charge
COPPER	AC	Antique Copper	No Charge

ACCESSORIES

Side Inserts – Must choose Designer color – Black Standard –

FSD-INSET1	Ⓜ	Two Crescent Inset Panels for FSD models	₹5112
FSD-INSET2	Ⓜ	Two Wave Inset Panels for FSD models	5112
FSDT-INSET1	Ⓜ	Two Crescent Inset Panels for FSDT models	5112
FSDT-INSET2	Ⓜ	Two Wave Inset Panels for FSDT models, Black	5112

Top Covers – Must choose Designer color – Black Standard –

FSD-CTLH	Ⓜ	Curved Hinged Header on control side (Fits 609 W x 149 H mm sign) for FSD and FSDT models	₹18034
FSD-CUSH	Ⓜ	Curved Header on non-control side (Fits 609 W x 149 H mm sign) for FSD and FSDT models	13135

Base Skirts – Requires 102 mm adjustable legs (not included) – Must choose Designer Color – Black Standard –

FSD-SQB		One Flat Front Panel ⑥ and one Flat Back Panel ⑦ (Fits 508 W x 93 H mm sign) and two Flat Side Panels ⑤ (Fits 473 W x 93 mm H sign) for FSD and FSDT models	₹15478
FSD-1CB		One Curved Front Panel ③ (Fits 647 W x 93 H mm sign) and one Flat Back Panel ⑦ (Fits 508 W x 93 H mm sign) and two Flat Side Panels ⑤ (Fits 473 W x 93 mm H sign) for FSD and FSDT models	27832
FSD-2CB		One Curved Front Panel ③ and one Curved Back Panel ④ (Fits 647 W x 93 H sign) and two Flat Side Panels ⑤ (Fits 473 W x 93 mm H sign) for FSD and FSDT models	40115
F-LEGS-4		102 mm Adjustable Legs for FSD and FSDT models	₹4686
FDWD-LEGS		102 mm Adjustable Legs for FDWDE models	4899

COLORS AND FINISHES – INSIDE BACK COVER

Display Rack Selections

Racks for FDWDE Models (Page 119)

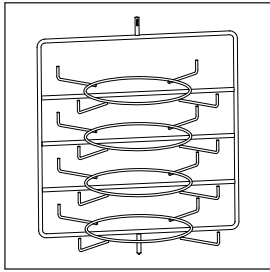

**4-Tier Circle Rack
FDWD4TCRR**
(Max. 381 mm dia. pans)
(83 mm between tiers)

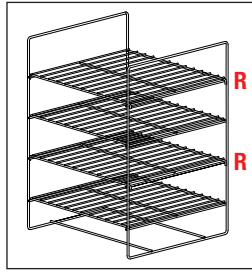

**4-Shelf Multi-Purpose
Rack FDW4SMP**
(Max. 457 x 330 mm)
(Half-Size Sheet Pans fit
FDWD-2 and -2X models only)
(95 mm between shelves)

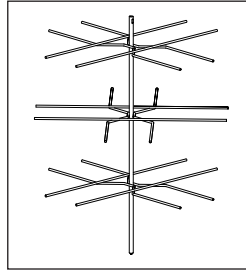

**3-Tier Pretzel Tree
Rack FDW3TPT**
(149 mm between tiers)

Racks for FSD/FSDT Models (Page 120)

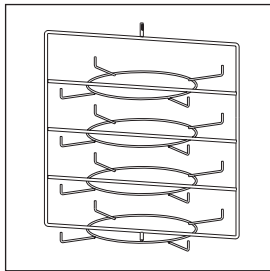

**FSDT 4-Tier Circle Rack
FSDT4TCR**
(Max. 483 mm dia. pans)
(117 mm between tiers)

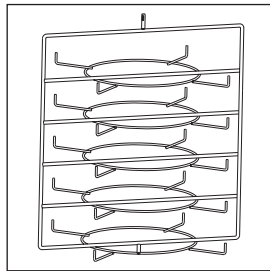

**5-Tier Circle Rack
FSDT5TCR**
(Max. 483 mm dia. pans)
(98 mm between tiers)

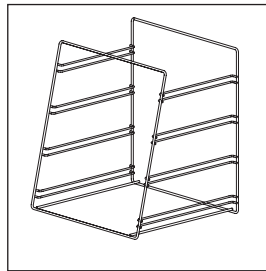

**FSDT 4-Tier Pan Rack
FSDT4TPR**
(Max. 457 x 330 mm)
Half-Size Sheet Pans
(89 mm between tiers)

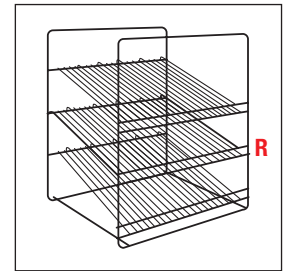

**FSDT 3-Shelf Angle Rack
FSDT3SAR**
(89 mm between shelves)

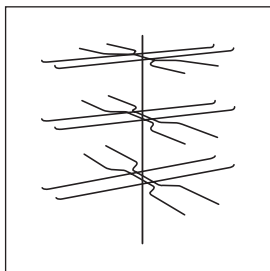

**FSDT 3-Tier Pretzel Tree
Rack FSDT3TPT**
(149 mm between tiers)

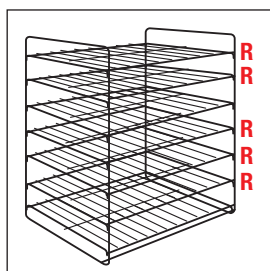

**FSDT 7-Shelf Multi-Purpose
Rack FSDT7SMP**
(Max. 457 x 330 mm)
Half-Size Sheet Pans
(64 mm between shelves)

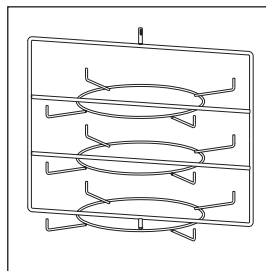

**FSD 3-Tier Circle Rack
FSD3TCR**
(117 mm between tiers)

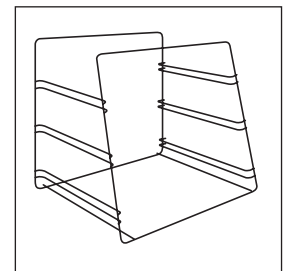

**FSD 3-Tier Pan Rack
FSD3TPR**
(89 mm between tiers)

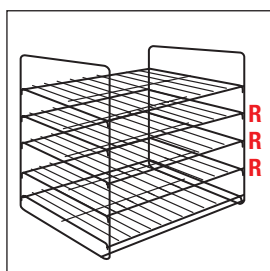

**FSD 5-Shelf
Multi-Purpose Rack
FSD5SMP**
(64 mm between shelves)

R Removable Shelves

Holding & Display
 Cabinets

Intelligent Heated Display Cabinet, Humidified

Hatco's Intelligent Heated Display Cabinet Humidified is the perfect way to showcase your pizzas and more. Regulating air temperature while at the same time balancing the humidity levels provides the best environment for food products. With 360° viewing, your food is guaranteed to get all the attention.

- Air flow pattern is designed to maintain consistent cabinet temperature without drying out food
- Air flow system enables the cabinet to recover temperature rapidly after opening and closing the door
- LCD touchscreen display on back of unit controls temperature, humidity and up to eight timers for each food location
- Energy efficient LED lighting to illuminate your food display
- USB port on back of unit makes it easy to establish standard, pre-programmed settings for consistency and reliability
- Adjustable arms can move up and down the back supports (unit can hold up to six pizza arms)
- The Arm is designed to hold maximum 559 mm pizza pan



IHDC-45
shown with
accessory risers



IHDC-28
shown with
accessory two
arms and one shelf

NOTE: Water filter, strainer and tubing are included with each cabinet to be installed on water supply connection.

Holding & Display Cabinets

INTELLIGENT HEATED DISPLAY CABINETS WITH HUMIDITY

Model	Dimensions W x D x H	Cabinet Opening Dimensions (W x H)	Voltage	Watts	Amps	List Price
IHDC-28	718 x 728 x 766 mm	558 x 525 mm	220-240	2596-3090	12.9	₹647520
IHDC-45	1149 x 728 x 766 mm	457 x 530 mm	220-240	2596-3090	12.9	746565

All Intelligent Heated Display Cabinet Models Feature:

Models Shipped With: IHDC-28: Stainless Steel unit with single french door, touchscreen controller, a lighted Power On/Off (I/O) switch, an air heating/circulation system, a humidity system, a USB port and LED display lights.

IHDC-45: Stainless Steel unit with sliding glass doors, touchscreen controller, a lighted Power On/Off (I/O) switch, an air heating/circulation system, a humidity system, a USB port, LED display lights and four adjustable arms.

Cord Location: Servers side, bottom left corner.

OPTIONS AND ACCESSORIES – PAGE 125
WATER QUALITY REQUIREMENTS – PAGE 145

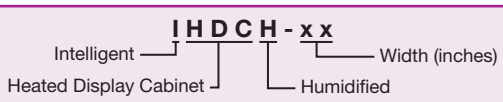



IHDCH-45 shown with standard arms, accessory risers and sign holders

Holding & Display Cabinets

OPTIONS (available at time of purchase only)

Designer Colors – Non-standard colors are non-returnable – Stainless Steel Standard –

IHDCH-BK	Unit in <i>Designer Black</i> in lieu of Stainless Steel unit	₹25560
IHDCHARM-BK-45	Four adjustable Arms in <i>Designer Black</i> in lieu of four Stainless Steel Arms for IHDCH-45	14555
IHDCHBASE-BK-28	Inside base in <i>Designer Black</i> in lieu of Stainless Steel base for IHDCH-28	1420
IHDCHBASE-BK-45	Inside base in <i>Designer Black</i> in lieu of Stainless Steel base for IHDCH-45	1846
FRTDOOR-28	Front, swing out, self closing door for IHDCH-28 (adds 51 mm to depth)	48564

ACCESSORIES

ADJARM-SS-28	Adjustable Arm in Stainless Steel for IHDCH-28	each ₹ 9940
ADJARM-SS-45	Adjustable Arm in Stainless Steel for IHDCH-45	each 10295
ADJARM-BK-28	Adjustable Arm in <i>Designer Black</i> for IHDCH-28	each 12070
ADJARM-BK-45	Adjustable Arm in <i>Designer Black</i> for IHDCH-45	each 13916
SHELF-SS-28	Shelf in Stainless Steel for IHDCH-28	each 13490
SHELF-BK-28	Shelf in <i>Designer Black</i> for IHDCH-28	each 11360
RISER12-SS	305 mm diameter x 38 mm H Riser in Stainless Steel	1491
RISER12-BK	305 mm diameter x 38 mm H Riser in <i>Designer Black</i>	2201
DOORLOCKIHDCH	Front Door lock for IHDCH-28 only	1349
RO KIT	Reverse Osmosis System with storage tank	91377
REGKIT	Water Pressure Regulator Kit (regulator, gauge and shut-off valve)	21016

SIGN HOLDERS (signs not included) – recommended sign size: 50 x 88 mm –

SGNHOLD-BASE-SS	Sits on base of unit in Stainless Steel	each ₹ 923
SGNHOLD-BASE-BK	Sits on base of unit in <i>Designer Black</i>	each 1775
SGNHOLD-LARM-SS	Customer left-hand side in Stainless Steel (clips onto Arm)	each 1065
SGNHOLD-LARM-BK	Customer left-hand side in <i>Designer Black</i> (clips onto Arm)	each 2059
SGNHOLD-RARM-SS	Customer right-hand side in Stainless Steel (clips onto Arm)	each 1065
SGNHOLD-RARM-BK	Customer right-hand side in <i>Designer Black</i> (clips onto Arm)	each 2059

FOOD PANS AND TRIVETS – PAGE 143
COLORS AND FINISHES – INSIDE BACK COVER

Mini Display Warmers

The Hatco Mini Display Warmer is perfect for cookies, pastries, wrapped or boxed sandwiches or any other product that does not require humidity. Hot air circulates throughout the entire cabinet, keeping food at safe-serving temperatures. The small footprint takes up little of your valuable counterspace while merchandising your breakfast, lunch or dinner offerings.

- Magnetically adjustable shelves allow horizontal or slanted displays
- Tempered glass sides and incandescent light showcase your food
- Thermostatic control with rocker switch
- Field reversible door hinge location
- Available as a 1-door or a 2-door pass-through model
- Doors may be field converted to any side
- Optional black hood with backlit graphic sign cut out on one side (sign included)



Magnetically adjustable shelves provide flexibility for a variety of product choices

MDW-1X with standard Designer color and optional hood with backlit sign cut out on one side (sign included)



MINI DRY DISPLAY WARMERS – NON-HUMIDIFIED

Model	Description	Dimensions W x D x H	Opening Dimensions W x H	Voltage Single Phase	Ship Weight	List Price
MDW-1X	1 door w/3 shelves	400 x 432 x 646 mm	315 x 396	230	21 kg	₹141787
MDW-2X	2 doors w/3 shelves	400 x 465 x 646 mm	315 x 396	230	24 kg	147254

All Mini Models Feature:

Door Hinges: Control Side: Left-hand side.

Customer Side (Two-door models only): Right-hand side.

Cord Location: Facing controls, lower right corner.

OPTIONS (available at time of purchase only)

Designer Color Posts for Base and Top Trim –

Non-standard colors are non-returnable –

RED	Warm Red	No Charge
BLACK	Black	No Charge
GRAY	Gray Granite	No Charge
WHITE	White Granite	No Charge
NAVY	Navy Blue	No Charge
GREEN	Hunter Green	No Charge
COPPER	Antique Copper	No Charge
BCKLIT-MDW	Black Hood with Backlit Sign cut out on one side - Sign included	₹7242

COLORS AND FINISHES – INSIDE BACK COVER

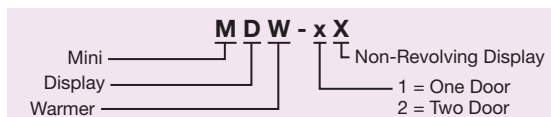

Flav-R-Savor® Portable Holding Cabinets

Hatco's energy efficient Flav-R-Savor® Portable Holding Cabinets will keep prepared foods at optimum serving temperatures for hours. The thermostatically-controlled heat and humidity allows food to be prepared in advance of peak serving periods.

- Allows you to hold product longer while saving you money through increased energy efficiencies
- Electronic control with digital read out, temperature range of 27°- 93°C and humidity controller
- The lower temperature range of 27°- 38°C can be used for proofing all types of breads
- All stainless steel interior
- No heating element in direct contact with water makes the unit easier to clean

- Accommodates Gastronorm pans
- Stacking kit available
- Doors are field convertible from left to right



FSHC-7W1-EE shown in Designer Black, with optional bumper kit, and right-hand hinged door



PORTABLE HOLDING CABINETS

Model	Description	Dimensions W x D x H	Interior Cabinet Capacity (W x D)	Voltage 50/60 Hz	Watts	Amps	Shipping Weight	List Price
FSHC-5W1-EE	Single Door	661 x 794 x 913 mm	532 x 676 mm	230	1182	4.9-5.1-5.4	113 kg	₹488977
FSHC-7W1-EE	Single Door	661 x 794 x 989 mm	532 x 676 mm	230	1182	4.9-5.1-5.4	101 kg	513827
FSHC-7W2-EE	2-Door Pass-Through	661 x 877 x 989 mm	532 x 676 mm	230	1182	4.9-5.1-5.4	105 kg	542440

All Models Feature:

Top Surface Dimensions: 654 W x 724 D mm.

Models Shipped with: 1829 mm cord and plug, 102 mm diameter casters (with 130 mm clearance), stainless steel heavy-duty door with left-hand door hinge and adjustable rack slides (seven for the -7WX-EE units, and five for the -5W1-EE unit).

Pan Capacity: -5W1-EE: 10 full sized sheet pans or 2/1 Gastronorm pans on 41 mm spacing, 5 full sized sheet pans or 2/1 Gastronorm pans on 83 mm spacing, 20 full sized hotel pans or 1/1 Gastronorm pans on 41 mm spacing, 10 full sized hotel pans or 1/1 Gastronorm pans on 83 mm spacing.

-7WX-EE: 14 full sized sheet pans [▣] or 2/1 Gastronorm pans on 35 mm spacing, 7 full sized sheet pans or 2/1 Gastronorm pans on 70 mm spacing, 14 hotel sized pans or 1/1 Gastronorm pans on 35 mm spacing.

Water Tank Capacity for Humidity System: 4 liters.

Cord Location: Recessed, back of unit, upper right side.

[▣]With purchase of extra pan slides.

WATER QUALITY REQUIREMENTS – PAGE 145

Holding & Display
Cabinets

OPTIONS (available at time of purchase only)

Colors (Side Panels) – Non-standard colors are non-returnable – Black Standard – SS	Stainless Steel	₹12780
Colors (Top) – Non-standard colors are non-returnable – Black Standard – SS	Stainless Steel	₹12780
EE-GLASS	Glass Door in lieu of Stainless Steel door (is not Energy Star qualified)	16117
EE-LPCAST	Low Profile Casters (FSHC-5W1-EE model only) (deduct 57 mm from height)	No Charge
EE-PLATFORM	Platform for mounting directly on a counter in lieu of casters (deduct 105 mm from height)	No Charge
EE-STACK-BLK	Designer Black Powdercoated Stacking Hardware mounted to bottom of cabinet for two FSHC-7W1 or two FSHC-5W1 units in lieu of casters (cannot have legs on lower unit)	No Charge
EE-STACK-SS	Stainless Steel Stacking Hardware mounted to bottom of cabinet for two FSHC-7W1 or two FSHC-5W1 units in lieu of casters (cannot have legs on lower unit)	No Charge
EE-BUMPER	Bumper Hardware - only for use with standard casters (add 3 mm to height)	₹30956
EE-4LEGS	102 mm Legs - in lieu of casters (deduct 13 mm from height)	No Charge
EE-6LEGS	152 mm Legs - in lieu of casters (add 45 mm to height)	No Charge

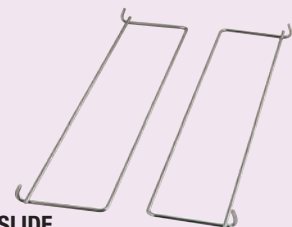

EE-1-SLIDE
Accessory

ACCESSORIES (available for purchase at any time)

EE-1-SLIDE	Extra Pan Slides	pair ₹5964
------------	------------------	------------

FOOD PANS AND TRIVETS – PAGE 143

COLORS AND FINISHES – INSIDE BACK COVER

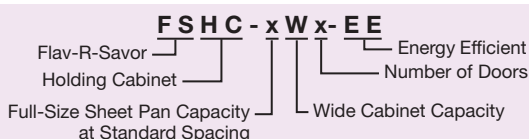

Flav-R-Savor® Low Profile, Humidified, Portable Holding Cabinets

Prepare food in advance of peak serving periods and safely hold it at optimum serving temperatures with the Flav-R-Savor® Portable Holding Cabinet. Thermostatically-controlled heat and humidity allows you to hold product for hours.

- Thermostatically-controlled heat and humidity holds hot food at optimum serving temperatures longer
- Allows preparation of food in advance of peak serving periods
- Accommodates Gastronorm pans
- Electrical components, controls, water reservoir and digital temperature readout are located at the top for easy access
- Reduced height – less than 762 mm high and wider footprint for increased capacity
- Insulated side walls, field reversible glass doors, large swivel casters with wheel locks and 1829 mm recessed cord and plug are standard
- Stacking kit available



FSHC-6W1 with accessory food pans

LOW PROFILE HOLDING CABINETS

Model	Description	Dimensions (W x D x H) <i>Height includes standard casters</i>	Opening Dimensions W x H	Voltage		Ship Weight	List Price
				Single Phase	Watts		
FSHC-6W1	1 Door	645 x 751 x 816 mm	546 x 483	220	1697	76 kg	₹415350
FSHC-6W2*	2 Doors	645 x 811 x 816 mm	546 x 483	220	1697	82 kg	443750

* FSHC-6W2 is a two-door pass-through single cabinet, not two units stacked.

All Low Profile Holding Cabinet Models Feature:

Top Surface Dimensions: 645 W x 657 D mm.

Models Shipped with: 1829 mm cord and plug, 102 mm diameter casters (with 130 mm clearance), six sets of adjustable angle slides.

Pan Capacity: Six 457 W x 660 D mm sheet pans or six 2/1 Gastronorm pans on 76 mm centers, eleven 457 W x 660 D mm sheet pans[□], eleven 2/1 Gastronorm pans on 38 mm centers[□], or twelve 508 W x 305 D x 64 H mm hotel pans.

Water Tank Capacity for Humidity System: 3 liters.

Cord Location: Recessed, back of unit, upper right side.

[□] With purchase of extra pan slides.

WATER QUALITY REQUIREMENTS – PAGE 145

OPTIONS (available at time of purchase only)

Colors (Side Panels) – Non-standard colors are non-returnable – Silver Gray Standard –

BLACK	Designer Black	₹12780
SS	Stainless Steel	12780

Colors (Top) – Non-standard colors are non-returnable – Silver Gray Standard –

BLACK	Designer Black	₹12780
SS	Stainless Steel	12780

6W-SS-DR Stainless Steel Door in lieu of Glass Door ₹ 5538

HD-SS-DR Heavy-Duty Stainless Steel Door with Positive Latch Handle 23146

6W1-LPCAST 51 mm Low Profile Locking Casters in lieu of Standard Casters (51 mm diameter with 76 mm clearance) (Overall Height 756 mm) No Charge

6W1-STACK Silver Gray Stack Hardware mounting on top of cabinet for two FSHC-6W1 units in lieu of Casters 5183

CORDWIND Bracket for holding Cord during transport 2130

ACCESSORIES

6W1-SLIDE Extra Pan Slides pair ₹5964

FOOD PANS AND TRIVETS – PAGE 143

COLORS AND FINISHES – INSIDE BACK COVER

6W1-SLIDE Accessory

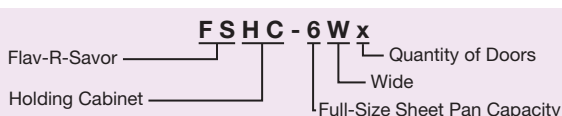
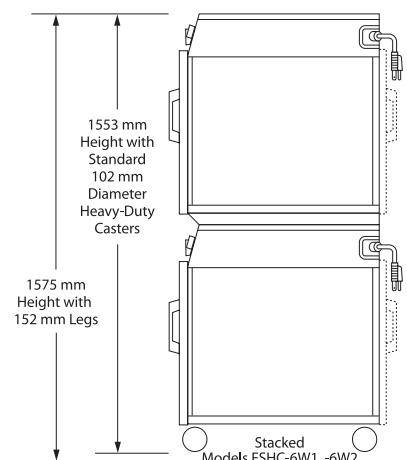
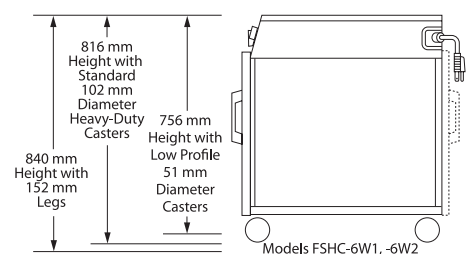

Flav-R-Savor® Humidified Portable Holding Cabinets

Prepare food in advance of peak serving periods and safely hold it at optimum serving temperatures with the Flav-R-Savor® Portable Holding Cabinet. Thermostatically-controlled heat and humidity allows you to hold product for hours.

- Thermostatically-controlled heat and humidity holds hot food at optimum serving temperatures longer
- Allows preparation of food in advance of peak serving periods
- Accommodates Gastronorm pans
- Electrical components, controls, water reservoir and digital temperature readout are located at the top for easy access
- Insulated side walls, field reversible glass doors, large swivel casters with wheel locks and 1829 mm recessed cord and plug are standard
- Stacking kit available



FSHC-7-1 with standard 102 mm casters and accessory food pans

PORTABLE HOLDING CABINETS

Model*	Description	Dimensions (W x D x H) Height includes standard casters	Cabinet Opening Dimensions (W x H)	Voltage Single Phase	Watts	Ship Weight	List Price
FSHC-7-1	1 Door	578 x 753 x 892 mm	470 x 559 mm	220	1697	79 kg	₹419113
FSHC-7-2*	2 Doors	578 x 812 x 892 mm	470 x 559 mm	220	1697	82 kg	447726

* 7 slides on each side. Sheet pans not included. 6-shelf multi-purpose rack can be substituted for angle slides at no charge.
* FSHC-7-2 is a two-door pass-through single cabinet, not two units stacked.

All Portable Cabinet Models Feature:

Top Surface Dimensions: W 575 x H 657 mm.

Models Shipped with: 1829 mm cord and plug, 102 mm diameter casters (with 130 mm clearance), seven sets of adjustable angle slides for W 457 x D 660 mm pans or W 305 x D 508 mm pans.

Pan Capacity: Seven 457 W x 660 D mm sheet pans on 76 mm centers, or seven 508 W x 305 D x 64 H mm hotel pans, or seven 1/1 Gastronorm pans.

Water Tank Capacity for Humidity System: 3 liters.

Cord Location: Recessed, back of unit, upper right side.

WATER QUALITY REQUIREMENTS – PAGE 145

Holding & Display
Cabinets

OPTIONS (available at time of purchase only)

Colors (Side Panels) – Non-standard colors are non-returnable – Silver Gray Standard –

BLACK	Designer Black	₹12780
SS	Stainless Steel	12780

Colors (Top) – Non-standard colors are non-returnable – Silver Gray Standard –

BLACK	Designer Black	₹12780
SS	Stainless Steel	12780

SS-DR	Stainless Steel Door in lieu of Glass Door	₹ 5538
--------------	--	---------------

HD-SS-DR	Heavy-Duty Stainless Steel Door with Positive Latch Handle	23146
-----------------	--	--------------

LPCAST	51 mm Low Profile Casters in lieu of standard Casters (51 mm diameter with 76 mm clearance)	2130
---------------	---	-------------

4LEGS	102 mm Adjustable Legs in lieu of standard Casters	No Charge
--------------	--	------------------

6SS	152 mm Stainless Steel Legs in lieu of standard Casters	No Charge
------------	---	------------------

7-1-STACK	Silver Gray Stacking Hardware mounted to top of cabinet for two FSHC-7-1 units in lieu of Casters	7313
------------------	---	-------------

CORDWIND	Bracket for holding Cord during transport	2130
-----------------	---	-------------

ACCESSORIES

SLIDEWIRE	Wire Shelf	per shelf ₹7739
------------------	------------	------------------------

FOOD PANS AND TRIVETS – PAGE 143

COLORS AND FINISHES – INSIDE BACK COVER

SLIDEWIRE
Accessory

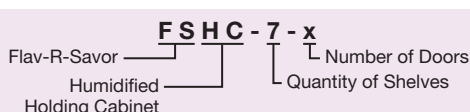
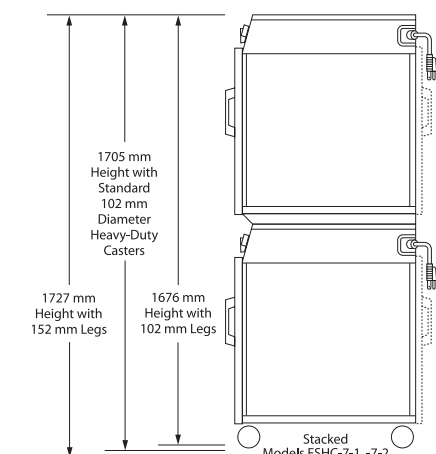
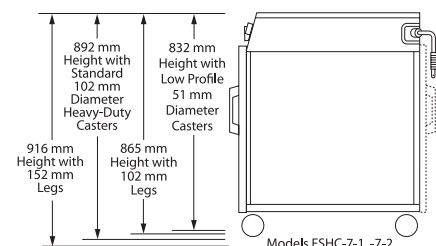
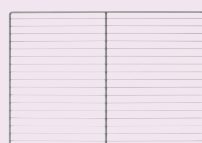

Flav-R-Savor® Heated Air Curtain Cabinets

The patented Flav-R-Savor® Heated Air Curtain Cabinet effectively and safely holds hot food hot without the use of doors, allowing immediate access to product. Warm air at the front of the cabinet is forced downward, through the ducts above the opening, forming a “curtain” of heated air. A portion of the heated air is drawn toward the rear of the cabinet, warming each pan.

- Perfect for holding wrapped or sealed product like tortillas, burritos and ribs, as well as product on sheet pans like biscuits, hamburger patties and baked potatoes
- Available in 2-pan and 3-pan models, single opening
- The 2-pan pass-through accommodates two full-size sheet pans or four half-size sheet pans, and the 4-pan unit accommodates four full-size sheet pans or eight half-size sheet pans
- Easy to use digital controls, a lighted On/Off switch and a 1829 mm cord and plug



FS2HAC-4PT 4-tier pass-through with accessory food pans

HEATED AIR CURTAIN CABINETS

Model	Description	Dimensions W x D x H	Cabinet Opening Dimension W x H	Voltage Single Phase	Hz	Watts	Ship Weight	List Price
FSHAC-2	2-Tier Warmer	257 x 581 x 460 mm	464 x 232 mm	220	50/60	1750	46 kg	₹327594
FSHAC-3*	3-Tier Warmer	257 x 581 x 775 mm	464 x 460 mm	220	50/60	1750	52 kg	341581
FS2HAC-2PT	2-Tier Pass Through	613 x 994 x 468 mm	459 x 206 mm	220	50	2538	75 kg	496219
FS2HAC-4PT	4-Tier Pass Through	613 x 994 x 671 mm	464 x 410 mm	220	50	3338	86 kg	541801

* Height includes 102 mm legs.

All Air Curtain Cabinet Models Feature:

Cord Location: FSHAC-2, -3: Top of unit towards the back, middle.
FS2HAC-2PT, -4PT: Top of unit towards the back, left side.

ACCESSORIES

FSHAC-BK2BK	Back-to-Back mounting on a Single Base - adds 25 mm to height (FSHAC-2 and FSHAC-3 models only)	₹7100
4"LEGS	102 mm Legs (Standard on 3-Tier and Pass-Through models)	3337

FOOD PANS AND TRIVETS – PAGE 143

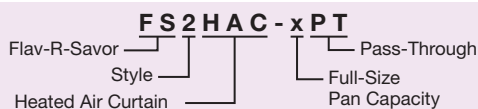

Induction Equipment

Cafeterias • Buffets
Supermarkets & Delis • Restaurants & Cafés
Clubs & Bars



IRNG-PC1-36 pg. 132



IRNG-PB1-36 pg. 133



IRNG-PC2F-36 pg. 134



IWRM-CD1-03 pg. 135



IWRM-B1-03 in white glass-ceramic top pg. 136

Rapide Cuisine® Drop-In High-Powered/Heavy-Duty Induction Hobs

Hatco's patent-pending Rapide Cuisine® Drop-In High-Powered/Heavy-Duty Induction Range offers industry-leading features and true back-of-house power in a commercial kitchen proof package.

The unit can be mounted flush or near flush with the optional trim ring. It features our Magnetic Power System (MPS) to deliver the highest power in its class! It has User Programmable Presets (UPP) for repeat menu items and a food temperature probe for more accurate cooking, plus a timer, high resolution color display and convenient power and temperature modes.

- Four surface temperatures sensors offer the most accurate control in its class
- Culinary equivalent of up to 31,000 BTUs gas
- High resolution TFT (thin film transistor) display instantly advises the operator of precise power (1 to 100), temperature (°C in one degree increments) and time control (30 seconds to 10 hours)
- Programmable mode so the operator can create preset programs for consistent cooking cycles
- Includes conformal-coated boards
- Easy to use color-coded selectable functions
- Large adaptive control for precise, fine control (slow turns) to spanning the full range in a single twist (fast turns)
- Pan Sense Technology (PST) activates the unit only when a suitable pan is placed on top
- Patterned, glass-ceramic top that is durable, easy to clean and helps scratches from heavy use appear less noticeable
- Easy to clean, fully-sealed top stops grease or moisture from penetrating the unit, even if the top gets broken
- Automatic shut-off to prevent overheating
- Withstands high ambient kitchen temperatures (up to 51°C)
- USB port for downloading updates or adding Modes from our website
- Includes a remote control panel and cord
- 1800 mm cord with plug



IRNG-PB1-36
shown in the standard finishes



Includes a food temperature probe which facilitates highly accurate cooking

Induction

HIGH-POWERED/HEAVY-DUTY DROP-IN INDUCTION HOBS

Model	Item No.	Dimensions W x D x H	Voltage Single Phase	Watts	Ship Weight†	List Price
IRNG-PB1-36	IRNGPB136SBCEE	343 x 368 x 91 mm	220-240	3300-3600	10 kg	₹137740

†Shipping weights are approximate.

All Drop-In High-Power/Heavy-Duty Models Feature:

Model Ships with: 1300 mm cable from the base unit to the control panel, 1800 mm cord and plug and temperature probe.

Cord Location: Rear right bottom base corner.

ACCESSORY (available at any time)

Holds unit nearly flush on the counter (for use where chair-step routing of a countertop material is not possible, but a flush mount look is desired) –

TRIM-PB1-36 Stainless Steel Trim Ring for IRNG-PB1-36 **₹3621**



Rapide Cuisine® Countertop High-Powered/Heavy-Duty Dual Induction Ranges

Hatco's patent-pending Rapide Cuisine High-Powered/Heavy-Duty Dual Induction Ranges offer industry-leading features and true back-of-house power in a commercial kitchen-proof package. These are dual units that are configured either front-to-back or side-to-side to optimize your countertop footprint.

The unit features our Magnetic Power System (MPS) to deliver the highest power in its class! It has User Programmable Presets (UPP) for repeat menu items and food temperature probes for more accurate cooking, plus a timers, high resolution color displays and convenient power and temperature modes.

- Heavy gauge stainless steel housing with side impact protection for the top
- Eight surface temperature sensors (four sensors per heating coil) offer the most accurate control in its class
- Culinary equivalent of up to 31,000 BTUs gas per burner
- High resolution TFT (thin film transistor) display instantly advises the operator of precise power (1 to 100), temperature (°C in one degree increments) and time control (30 seconds to 10 hours)
- 3-stage programming mode so the operator can create preset programs for consistent and labor-saving cooking cycles
- Includes a grease filter and intake plus exhaust fans
- A fully sealed 6 mm glass-ceramic top with conformal coated boards keeps pan heat, moisture and grease away from internal electronics
- Elegant, low-profile design, one of the lowest on the market
- Pan Sense Technology (PST) activates the unit only when a suitable pan is placed on top
- Food temperature probes for more accurate cooking
- Withstands high ambient kitchen temperatures (up to 51°C)
- USB ports for downloading updates or adding Modes from our website

IRNG-PC2F-36
Front-to-back configuration shown in the standard finishes



Includes food temperature probes which facilitates highly accurate cooking

Close up of patterned black glass-ceramic top – helps prevent noticeable scratches due to heavy use

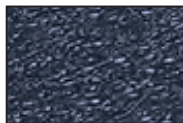

IRNG-PC2S-36
Side-to-side configuration shown in the standard finishes



Induction

COUNTERTOP DOUBLE HIGH-POWERED/HEAVY-DUTY DUAL INDUCTION RANGES

Model	Item No.	Configuration	Dimensions W x D x H	Voltage Single Phase	Watts (per coil)	Total Power (watts)	Ship Weight [†]	List Price
Front to Back Ranges								
IRNG-PC2F-16	IRNGPC2F16BS	Front to Back	356 x 753 x 125 mm	220-240	1430-1560	2860-3120	19 kg	₹255529
IRNG-PC2F-36	IRNGPC2F36IEC	Front to Back	356 x 753 x 125 mm	220-240	3300-3600	6600-7200	19 kg	283929
Side to Side Ranges								
IRNG-PC2S-16	IRNGPC2S16BS	Side to Side	356 x 753 x 125 mm	220-240	1430-1560	2860-3120	19 kg	₹255529
IRNG-PC2S-36	IRNGPC2F36IEC	Side to Side	356 x 753 x 125 mm	220-240	3300-3600	6600-7200	19 kg	283929

[†]Shipping weights are approximate.

All Countertop High-Powered/Heavy-Duty Models Feature:
Models Shipped with: 1800 mm cord and plug (includes food temperature probes).
Cord Location: Rear left bottom base corner.

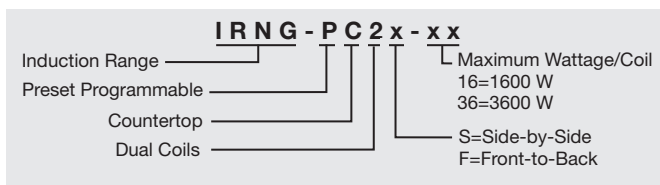

Palletti™ Drop-In Induction Warmers

Hatco's Palletti Drop-In Professional Induction Warmers offer a safe, efficient and attractive way to keep hot foods hot. Perfect for serving applications such as buffet lines and hospitality suites. The warmer has five simple and precise settings, which allow for a wide variety of foods to be held both safely and at optimum quality. The units are also memory retentive, so once turned off and back on, the last setting will resume.

This unit can be mounted flush or near flush with the optional Trim Ring.

- Adaptable for buffets and many other front-of-the-house applications to give the most attractive and visible food presentations
- Pan Sense Technology (PST) activates the unit only when a suitable pan is placed on top
- Once installed the glass-ceramic top never needs to be removed. For service or replacement, the lower housing can be removed separately.
- Energy efficient, quiet and safe operation with no open flames as with traditional warming presentations
- Black glass-ceramic top is durable and easy to clean
- Safety features and convenience features such as automatic shut-off to prevent overheating
- Includes remote control panel and cord

IWRM-B1-1313-05
with white
glass-ceramic top

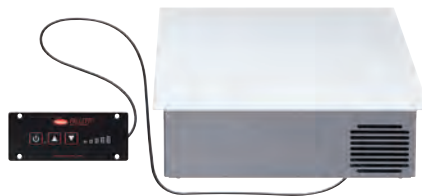

IWRM-B1-1313-05
with black
glass-ceramic top

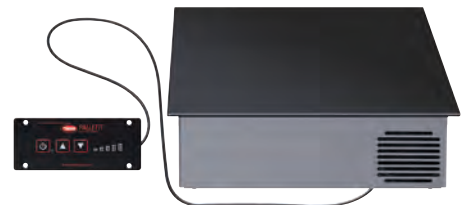

DROP-IN INDUCTION WARMERS

Model	Item No.	Dimensions W x D x H	Glass- Ceramic Top	Voltage Single Phase	Watts	Amps	Ship Weight*	List Price
IWRM-B1-1313-05	IWRMB113135BBS	330 x 330 x 108 mm	Black	220-240	500	2.3-2.1	6 kg	₹63829
IWRM-B1-1313-05	IWRMB113135WBS	330 x 330 x 108 mm	White	220-240	500	2.3-2.1	6 kg	63829

*Shipping weights are approximate.

All Drop-In Induction Warmers Feature:

Models Shipped with: 1000 mm cable from the base to the control and 1800 mm cord and plug.

Cord Location: Rear left bottom base corner.

ACCESSORIES (available for purchase at any time)

TRIM-IWRM-1B	Trim Ring in Stainless Steel (holds unit nearly flush on a stainless steel counter or any similar material)	₹3195
IWRM-FLUSHBKT	Flush Mount Bracket	4260

IWRM - x 1 - x x x x - x x

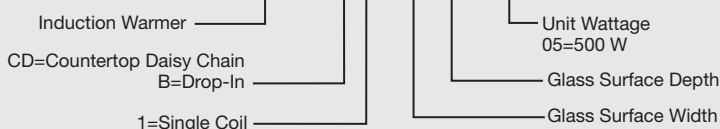

Light Cooking Equipment

*Supermarkets & Delis • Restaurants & Cafés
Clubs & Bars • Concessions*



SNACK-2 with accessory chelky plates *pg. 138*



RCTWM-2B with standard Belgian waffle plates *pg. 139*



TMS-1 *pg. 140*

Snack System

The Hatco/Suntec Snack System will help expand your menu and your sales. With a single or dual electric baker, you can easily switch the replaceable plates to serve breakfast items, lunch foods and a variety of snacks in between. Freshly bake as many or few items as you need, resulting in no waste at the end of the day. Add more variety to your menu in small quantities and increase sales according to the season, time of day and location.

- Adjustable time/temperature controls enable operators to cook continuous, consistent quality products
- Exclusive heating elements provide exceptional heat distribution throughout the entire cooking plate, ensuring even cooking of each product
- Four programmable preset buttons for each cooking cycle. A cooking cycle consists of three different settings:
 - Temperature
 - Time
 - Top Cooking Plate Power
- One-touch release with latch opener for easy plate replacement
- Removable plates are easily cleaned with warm, soapy water
- Compact design is suitable for any location
- Adjustable temperature allows for multiple menu options
- Comes with standard Round Belgian Waffle Plates and one additional set of plates of your choosing

NOTE: Comes with standard Round Belgian Waffle Plates and one additional set of plates of your choosing.

SNACK-1 with Chelky plate



SNACK-2 with Belgian plate



SNACK SYSTEM

Model	Item #	Description	Dimensions (W x D x H)	Voltage	Watts	Amps	Shipping Weight*	List Price
SNACK-1	SNACK1.BS	Single	264 x 446 x 203 mm	220-240	823-980	3.7-4.0	11 kg	₹107338
SNACK-2	SNACK2.BS	Double	537 x 446 x 203 mm	220-240	1647-1960	7.5-8.2	19 kg	173866

All Snack System Models Feature:

Models Shipped with: a cleaning brush, tool for switching out plates, standard Round Belgian Waffle Plates and an additional set of plates of your choosing.
Cord Location: Back of unit, bottom left-hand side.

ACCESSORIES

Interchangeable Cooking Plates –		
FREESTYLE	Freestyle Plates	₹15975
BELGIAN	Belgian Plates	15975
COFFEEBEAN	Coffee Bean Plates	15975
SANDWICH	Sandwich Plates	15975
PANINI	Panini Plates	15975
DONUT	Donut Plates	15975
CHELKY	Chelky Plates	15975
WM-BRUSH	Nylon Brush	₹1136



Light Cooking Equipment



Rectangular Waffle Makers

Hatco®/Suntec Rectangular Waffle Makers cook continuous, excellent-quality waffles for commercial kitchens, display cooking locations, and buffets. The adjustable time and temperature controls enable operators to cook consistent quality waffles from the variety of different batters.

- Exclusive heating elements provide exceptional heat distribution throughout the entire cooking plate, ensuring even cooking of each waffle
- Stainless steel frame, cast aluminum cooking plates
- Belgian-style cooking plates produce 25 mm thick waffles
- LED display shows timer, temperature and status information
- Simple push button control panel featuring a stand-by On/Off, timer/temp toggle, higher/lower selection, and start/stop
- Fast initial heat-up time, excellent heat retention and recovery delivers high productivity and consistent results



RCTWM-2B with Belgian plate



RCTWM-1B with Belgian plate

RECTANGULAR WAFFLE MAKERS

Model	Item Number	Description	Dimensions (W x D x H)	Voltage	Watts	Amps	Shipping Weight	List Price
RCTWM-1B	RCTWM1B.BS	Single, Rectangular, Belgian	244 x 3669 x 203 mm	220-240	823-980	3.7- 4.0	7 kg	₹ 61523
RCTWM-2B	RCTWM2B.BS	Dual, Rectangular, Belgian	498 x 3669 x 203 mm	220-240	1647-1960	7.5-8.2	15 kg	107030

All Hatco/Suntec Rectangular Waffle Maker Models Feature:

Models Shipped with: Stainless Steel frame and aluminum cooking plates, On/Off power switch, multi-function control panel, removable drip tray, nylon brush and a 1829 mm cord and plug.

Cord Location: Back of unit, lower left corner.

ACCESSORIES

WM-BRUSH Nylon Brush ₹1136

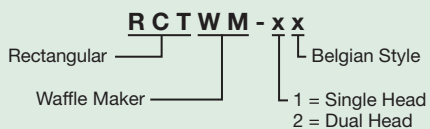

Therm-Max® Salamander

Hatco's Therm-Max® Salamander is specially designed for versatility in the kitchen with the capabilities to cook, grill and reheat food. The unparalleled start-up speed is a result of "Instant/On" heating elements located in the upper housing of the salamander. The Therm-Max Salamander is energy efficient and easy to operate.

- The high-powered heating elements are ready for use within 8 seconds
- Two sets of independently-controlled heating element sections give the benefits of flexibility and energy conservation
- Cook mode selection switch controls left, right or both locations
- Made of stainless steel for easy cleaning and durability
- Can be placed on a countertop or mounted to a brick or cement wall



THERM-MAX SALAMANDER

Model	Dimensions W x D x H	Voltage 50/60 Hz	Phase	Cooking Area W x D x H	Watts	Amps	Ship Weight	List Price
TMS-1	600 x 503 x 515 mm	230/400	3	540 x 373 x 90-260 mm	4000	8.7	72 kg	₹187795

All Therm-Max Salamander Models Feature:
 Models Shipped with: Grill, drip pan and wall mounting bracket.
 Power Location: Hardwired, back of unit, lower right corner.

Light Cooking Equipment

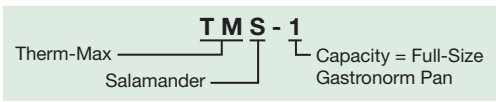

Specialty Water Equipment

*Cafeterias • Convenience Stores
Supermarkets & Delis • Restaurants & Cafés
Clubs & Bars • Concessions*



FM-5 *pg. 142*



FM-5 Faucet extension adds 130 mm to height
on top *pg. 142*



FM-5 under-counter main unit *pg. 142*

Flow-Max® Under-Counter Water Dispenser

The Hatco Flow-Max® Under-Counter Water Dispenser delivers hot or ambient water for food preparation, drinking or cleaning. With a temperature range from 65° - 95°C and programmable on-demand dispense volume, you have hot water at your fingertips.

- 5 liter stainless steel tank
- Stylish faucet design with a tear-drop shape base mount and easy-touch controls
- Energy-saving, programmable power-save mode
- Built-in filter with a 0.5 micron rating



UNDER-COUNTER WATER DISPENSER

Model	Dimensions		Voltage	Watts	Hz	Amps	Ship Weight	List Price
	Above counter W x D x H	Under-counter unit W x D x H						
FM-5	46 x 46 x 167 mm	342 x 362 x 391 mm	230	1800	50/60	7.8	19 kg	₹143775

All Under-Counter Water Dispenser Models Feature:

Models shipped with: 5 liter stainless steel tank, 125 mm faucet extension, drain font, a water filter and a 1.3 m cord and plug set.

Liquid Capacity: 25 liters hot water per hour.

Cord Location: Rear right from front view.



Faucet extension adds 130 mm to height on top



Faucet touch control - Hot and Ambient -



Under-counter main unit



Under-counter main unit control panel

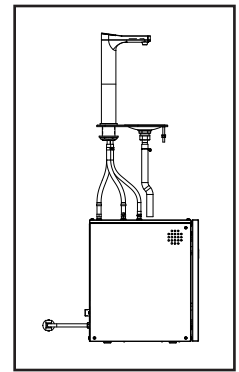

Drawing of unit, above and under counter

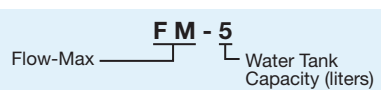

Food Pans And Trivets

ALUM PAN



FOOD PANS

Model	Description	Dimensions	List Price
ALUM PAN	Half-Size Sheet Pan	457 W x 330 D mm	₹1988
18" SHEET PAN	Full-Size Sheet Pan	457 W x 660 D mm	2769
14" PIZZA PAN	Perforated Pizza Pan	356 mm Diameter	2130
15" PIZZA PAN	Perforated Pizza Pan	381 mm Diameter	2272
16" PIZZA PAN	Perforated Pizza Pan	406 mm Diameter	2343
18" PIZZA PAN	Perforated Pizza Pan	457 mm Diameter	2485
ST PAN 1/3	Third-Size Stainless Steel Pan	324 W x 175 D x 64 H mm	3550
ST PAN 1/2	Half-Size Stainless Steel Pan	324 W x 264 D x 64 H mm	3976
ST PAN 2	Full-Size Stainless Steel Pan	324 W x 527 D x 64 H mm	4828
ST PAN 4	Full-Size Stainless Steel Pan	324 W x 527 D x 102 H mm	6106



FOOD PANS AND TRIVETS

Model	Description	Dimensions	List Price
HDW 4" PAN	Full-Size Stainless Steel Food Pan	324 W x 527 D x 102 H mm	₹6106
HDW 6" PAN	Full-Size Stainless Steel Food Pan	324 W x 527 D x 152 H mm	6674
PL PAN 1/2	Half-Size Plastic Food Pan	324 W x 267 D x 64 H mm	3621
PL PAN 1/4	Quarter-Size Plastic Food Pan	162 W x 267 D x 64 H mm	2911
PL LID 1/2	Half-Size Plastic Pan Lid		2698
PL LID 1/4	Quarter-Size Plastic Pan Lid		1846
Wire Trivets Stainless –			
TRIVET (1/2)SS	Half-Size	259 W x 194 D mm	₹6674
TRIVET SS	Full-Size	257 W x 457 D mm	9088

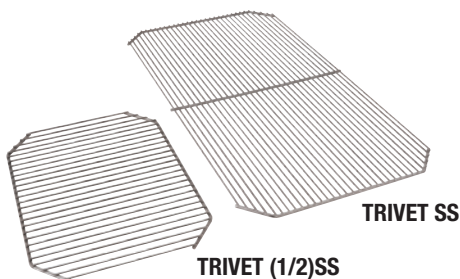



General Information

Price Policy: Prices are in Rupees and are subject to change without notice. Prices and discounts apply to accessories at time of initial equipment order only, not when ordered at a later date.

Instructions for payment remittance:

Bank Name: CITIBANK N.A.
Bank Account Number: 714897012
Bank Account Name: Hatco Foodservice Equipment India Private Limited
IFSC/RTGS Number: CITI0100000

Standard Shipment Terms: EX-WORKS Bangalore, India

ALL HATCO PRODUCTS SHIPPED WITH INSTALLATION AND OPERATING INSTRUCTIONS.
CONSULT LOCAL CODES BEFORE INSTALLING EQUIPMENT.

E-mail inquiries and request to :
supportindia@hatcocorp.com

E-mail orders to: ordersindia@hatcocorp.com.

Telephone: +91-8870-920-999

Technical Service Questions:
technicalserviceindia@hatcocorp.com

Parts and Equipment Questions:
customerserviceindia@hatcocorp.com

www.hatcocorp.com

Hatco products are manufactured for commercial use only.

See product specification sheet for the appropriate approvals.

Ordering Procedures

CUSTOMER NOTE –

To ensure prompt and accurate processing of your order, please provide the following information:

ALL PRODUCTS –

1. Model number, voltage and phase.
2. Specify options and accessories as required. Options are not retrofittable.
3. Consult factory when ordering equipment for special applications.
4. FAX and e-mail orders are acceptable and do not require confirmation.

Limited Warranty

For the full information pertaining to the Hatco warranty protection for your equipment, go to our website at:

www.hatcocorp.com

Step 1: make sure you are on your region

Step 2: in the **SUPPORT** drop-down, select **WARRANTY**

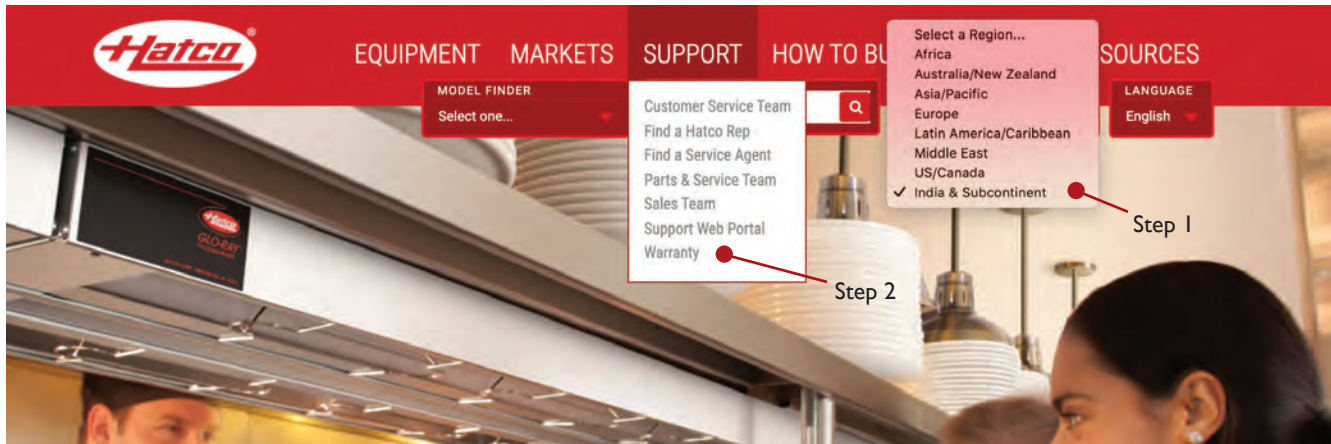

Water Quality Requirements

Water supply in excess of 0,75 grains of hardness per liter (GPL) must be treated and softened before being used. Water containing over 0,75 GPL will decrease the efficiency and reduce the operating life of the unit.

NOTE: Product failure caused by liming or sediment buildup is not covered under warranty.

Returns

No product will be accepted on a return shipment without a Material Return Authorization from Hatco Sales Department. Products returned at customer's convenience are subject to inspection and a restocking

charge of 25% of EX-WORKS, freight and related expenses for shipper's account; contact Hatco.

Damaged Freight Policy

All freight should be inspected during the receiving process for possible damage. Should there be a question about the condition of the equipment, it is better to refuse the shipment. If damage is found after delivery, it is the consignee's (receiver) responsibility to notify the carrier within (24) hours of delivery.

All Hatco Shipments specify an Incoterm 2010 in which the shipment was made. Incoterms determine who bears the risk of cargo damage or loss at any given point of shipment and therefore who pays in the event of loss or damage. If it is found that any part of the shipment has sustained damage during transportation, Hatco Corporation must be contacted as well as immediately notifying the last carrier.

For assistance, contact Hatco via e-mail at: intlshipping@hatcocorp.com and provide information listed below:

1. Hatco Shipment Number
2. Delivery date and date damage was discovered
3. Contact name, phone number and email address
4. Type of unit damaged including model and serial number
5. Extent of damage
6. Pictures of damage as well as packaging



Hatco has a wealth of resources to help you choose and order the correct equipment with ease. Log on to the Hatco website: www.hatcocorp.com and look under the “Resources” panel on the right hand side of the page.

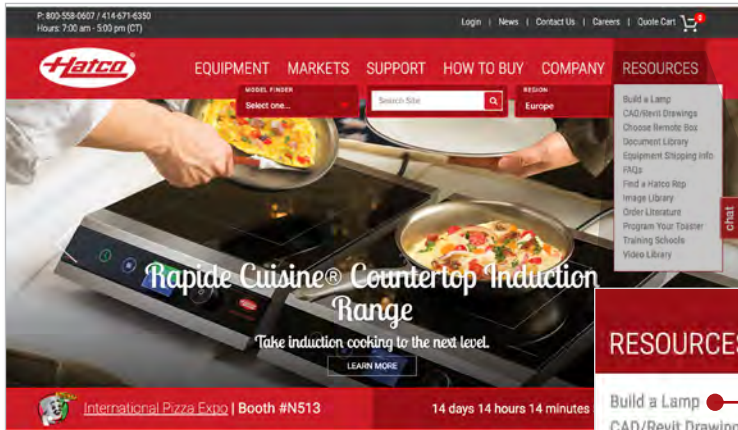

BUILD A LAMP



RESOURCES

- Build a Lamp
- CAD/Revit Drawings
- Choose Remote Box
- Document Library
- Equipment Shipping Info
- FAQs
- Find a Hatco Rep
- Image Library
- Program Your Toaster
- Training Schools
- Video Library

CHOOSE REMOTE BOX

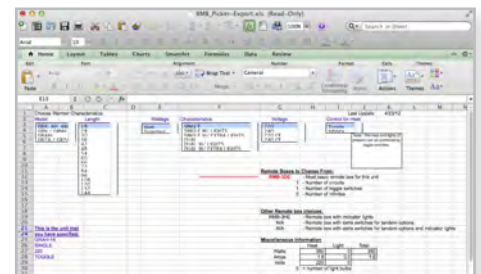

DOCUMENT LIBRARY

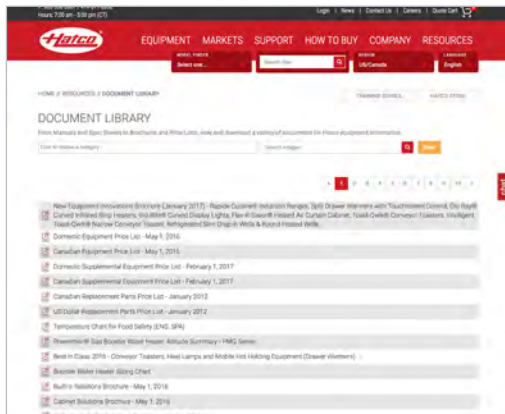

EQUIPMENT SHIPPING INFO

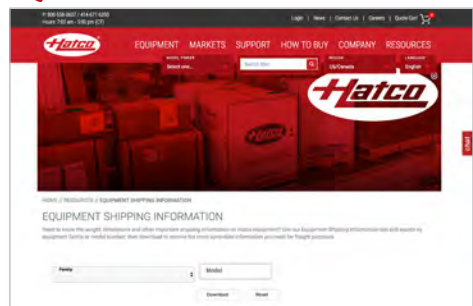

VIDEO LIBRARY

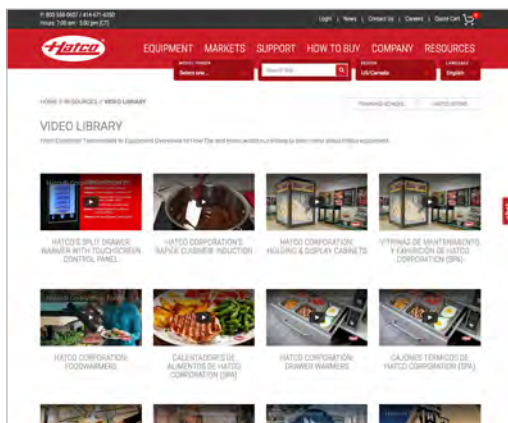
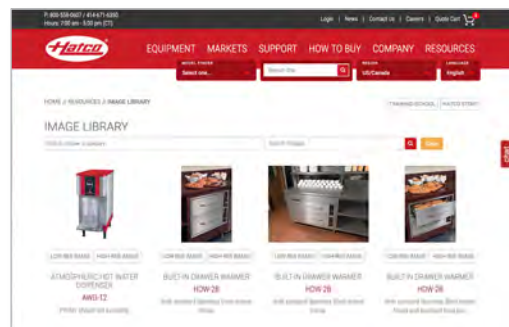

IMAGE LIBRARY



Product Index

by model number

TOASTERS	2-9	BUILT-INS	86-96
WELLS	10-40	DRAWER WARMERS	97-101
DECORATIVE LAMPS & DISPLAY LIGHTS	41-48	MERCHANDISERS	102-116
STRIP HEATERS	50-65	HOLDING & DISPLAY CABINETS	117-130
FRY STATION	66-70	INDUCTION	131-136
CARVING STATIONS	71-73	LIGHT COOKING	137-140
PORTABLES	74-85	SPECIALTY WATER EQUIPMENT	141-142

CDW 98	GRCMW 112	HWBI-S 22-23, 36-37
CLED 49	GRCSCL, GRCSCLH 73	HWBI-xQT 24-25, 31, 36-37
CSSBX, CSSBFX 87, 89	GRFF, GRFFL, GRFFB, GRFFBL 67-68	HWBRT 24-25, 32, 36-37
CSUX 91	GRFHS 69-70	HWBRTQ 24-25, 33, 36-37
CSBFX 90	GRFS 69-70	HWBRT-43 24-25, 34, 36-37
CWBX, CWBX-S 13-16	GRH 54-55	HWBRT-xQT 24-25, 35-37
DCS 72	GRHD, GRHDH 115-116	HXMH, HXMH-xxD 108-109
DL 42-47	GRHW 83	HXMS, HXMS-xxD 108-109
FDWDE 119	GRS 81-82	IHDCH 124-125
FM-5 142	GRSB 95	IRNG 132-134
FS2HAC 130	GRSBF 96	ITQ 3
FSD 120-123	GRSDH, GRSDH-xxD 104-105	IWB, IWB-S 11-12, 16
FSDT 120-123	GRSDS, GRSDS-xxD 104-105	IWRM 135-136
FSHAC 130	GRSDS/H 103	MDW 126
FSHC-6W 128	GRSR 75	PWB, PWC 118
FSHC-7 129	GRSS 78	RCTHW 40
FSHC-EE 127	GRSSB 92	RCTWM 139
FTBX, FTBX-S 17-18	GRSSR 76-77	RHW 39
GM5AH 51	HBG 79	RMBs 64
GM5AHL 52-53	HBGB 93-94	SNACK 138
GMFFL 67	HBGBH 93-94	TK 9
GMHD, GMHDH 111	HCSBFX 89	TM 6
GR2BW 84-85	HCSSBX, HCSSBFX 88-89	TM3 5
GR2SDH, GR2SDH-xxD 106-107	HDW 99-101	TMS 140
GR2SDS, GR2SDS-xxD 106-107	HDW-xRx 99, 101	TPT 4
GR3SDS 110	HGSM 80	TQ 8
GRAH, GRAHL 54-55	HLC5 48	TQ3 7
GRAH-xxD, GRAHL-xxD 56-57	HW-FUL 38	UGAH, UGAHL 58, 60
GRAIH, GRAIH-xxD 61-62	HWB-FUL, HWBQ-FUL 24-28, 36-37	UGAH-xxD, UGAHL-xxD 59-60
GR-B 67-68	HWB-43 24-25, 29, 36-37	UGFF, UGFFL, UGFFB, UGFFBL 67-68
GRBW 84-85	HWB-xQT 24-25, 30, 36-37	
GRCD, GRCDH 113-114	HWBI, HWBI43 19-21, 36-37	

Paint Chip and Stone Sample Colors

DESIGNER COLORS

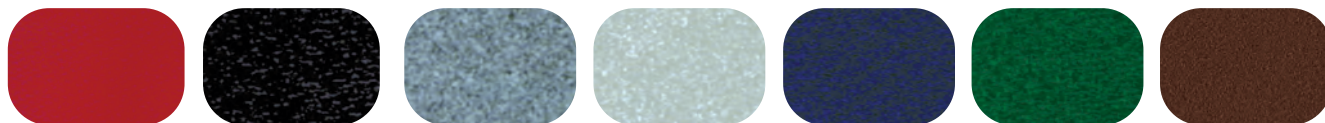

Warm Red

Black

Gray
Granite

White
Granite

Navy Blue

Hunter
Green

Antique
Copper

GLOSS FINISHES



Smooth
White

Gleaming
Gold

Glossy
Gray

Bold
Black

Radiant
Red

Brilliant
Blue

Clear Brushed
Metal Finish

PLATED FINISHES



Bright
Brass

Bright
Nickel

Bright
Copper

Antique
Nickel

Antique
Brass

Antique
Bronze

SIMULATED STONE* COLORS



Gray
Granite

Bermuda
Sand

Night Sky

*Colors are a representation and may not exactly match our colors.
Consult factory for possible color matching options on these colors.
Non-standard colors are non-returnable.*

To order a Hatco Paint Chip & Stone Sample Colors Sheet, visit www.hatcocorp.com / Order Literature / Sales Literature / Sell Sheets.

* Simulated stone is Swanstone®



People who serve, products that solve.®



Hatco Foodservice Equipment India Private Limited

Hatco India registered office:
54- Deepak Building
13 - Nehru Place
New Delhi - 110019
India

Warehouse/Customer Service Support +91-8870-920-999:
No 5/486-1, C Krishna Group Compound,
SIPCOT Post, Hosur,
Krishnagiri District,
Tamil Nadu, 635126,
India

www.hatcocorp.com

Hatco Foodservice Equipment Price List • April 1, 2020