



Global Foodservice Equipment Catalog



Good Thinking®





## Over 100 years of commercial expertise

Since 1911, businesses have relied on Hamilton Beach Commercial® for top-performing, durable equipment. From innovative, high-performance blenders to vacuum packaging machines, we have everything you need to keep your business running smoothly, whether you operate a single restaurant, bar, or manage a chain.

Hamilton Beach Commercial® has a proud history of designing products with the end user in mind, focusing on quality, durability, and innovation. Another key to our customer-centric process is to support you with exceptional service every step of the way. Think of Hamilton Beach Commercial® as partners in your business — we go out of our way to ensure your satisfaction.

### Beverage Prep

2-3	Bar Blenders
4-5	High-Performance Blenders
6-7	Beverage Automation
8-9	Drink Mixers

### Food Prep

10-11	Expeditor™ Culinary Blenders
12-13	Back-of-the-House Equipment
14-15	FreshMark™ Juicers
16-18	PrimaVac™ Vacuum Packaging

### Accessories

20-23	Supplies and Parts
-------	--------------------



Thoughtful products with meaningful innovation ... now that's **Good Thinking**®

# Bar Blenders

Powering the front of the house

## HBB908®



### 908® Blender

½ peak\* HP motor

**Blend Drinks in 25 Seconds** – Perfect for operations that serve 1-15 drinks daily.

**Two Speeds** – Provide versatility and precision blending for a wide variety of drinks.

**4 Durable Stainless Steel Blades** – Made to last and get the job done fast.

**44 oz./1.25 L Container** – Break-resistant polycarbonate container with filler-cap and easy-to-read measurement marks makes filling and pouring easy.

**Sure Grip™ Feet** – Hold blender securely in place.

## HBB909



### 909 Blender

½ peak\* HP motor

**Blend Drinks in 25 Seconds** – Perfect for operations that serve 1-15 drinks daily.

**Two Speeds** – Provide versatility and precision blending for a wide variety of drinks.

**4 Durable Stainless Steel Blades** – Made to last and get the job done fast.

**32 oz. Stainless Steel Container** – Durable stainless steel offers long-lasting performance.

**Sure Grip™ Feet** – Hold blender securely in place.

## HBB250



### Rio® Blender

¾ peak Hp\* motor

**Blend Drinks in 20 Seconds** – Perfect for operations that serve 15-25 drinks daily.

**Wave~Action® System** – Unique container design continually forces mixture down into blades for a super-creamy drink profile every time.

**Two Speeds with Pulse Option** – Offers versatility and precision blending for a wide variety of drinks.

**4 Durable Stainless Steel Blades** – Made to last and get the job done fast.

**Jar Pad Sensor** – Turns off motor when container is not in place to reduce clutch grinding (230V only).

**44 oz./1.25L Container** – Break-resistant polycarbonate container is stackable for storage.



**Ship Weight:** 7.3 lbs/3.3 kg

**Warranty:** 1 year parts & labor

#### 120V Specifications:

HBB908  
120V~, 60 HZ, 3.5A



#### 230V Specifications:

HBB908-CE  
HBB908-UK  
220-240V~, 50-60 HZ, 400W



**Ship Weight:** 7.4 lbs/3.4 kg

**Warranty:** 1 year parts & labor

#### 120V Specifications:

HBB909  
120V~, 60 HZ, 3.5A



#### 230V Specifications:

HBB909-CE  
HBB909-UK  
220-240V~, 50-60 HZ, 400W



**Ship Weight:** 9.7 lbs/4.4 kg

**Warranty:** 2 years parts & labor

#### 120V Specifications:

HBB250R  
120V~, 60 HZ, 4A



#### 230V Specifications:

HBB250-CE  
HBB250-UK  
HBB250-CCC  
220-240V~, 50-60 HZ, 450W



**Most bar blenders are pushed to their limit on a daily basis**, so they need to be extremely durable and easy to use. These blending workhorses are built to last and can keep up with the demands of the busiest bars. All models feature intuitive controls, so bartenders can focus on blending and serving customers instead of wasting time on complicated functions.

## HBB250S



### Rio® Blender ¾ peak Hp\* motor

**Blend Drinks in 20 Seconds** – Perfect for operations that serve 15-25 drinks daily.

**Wave~Action® System** – Unique container design continually forces mixture down into blades for a super creamy drink profile every time.

**Two Speeds with Pulse Option** – Offers versatility and precision blending for a wide variety of drinks.

**4 Durable Stainless Steel Blades** – Made to last and get the job done fast.

**Jar Pad Sensor** – Turns off motor when container is not in place to reduce clutch grinding (230V only).

**32 oz./0.95L Stainless Steel Container** – Built for long-lasting performance.

## HBH450



### Tango® Blender 1 Hp motor

**Blend Drinks in 15 Seconds** – Perfect for operations that serve 20-50 drinks daily.

**Wave~Action® System** – Unique container design continually forces mixture down into blades for a super creamy drink profile every time.

**Timer and 2 Speeds with Pulse Option** – The timer is indispensable for busy bars and 2 speeds offer precision blending for a wide variety of drinks.

**All-Metal Drive Coupling** – For long-lasting blending performance.

**4 Durable Stainless Steel Blades** – Made to last and get the job done fast.

**48 oz./1.4 L Stackable Container** – Break-resistant polycarbonate container is stackable for storage.

## ACCESSORIZE

Keep your blenders in top condition and your business running smoothly

### 98908 Blender Repair Kit

For 908 and 909 series bar blenders



### 98250 Blender Repair Kit

Rio kit for HBB250 and HBB250S series



### 98450 Blender Repair Kit

Tango kit for HBH450 series



**Ship Weight:** 10 lbs/4.5 kg

**Warranty:** 2 years parts & labor

#### 120V Specifications:

HBB250SR  
120V~, 60 HZ, 4A



#### 230V Specifications:

HBB250S-CE  
HBB250S-UK  
HBB250S-CCC  
220-240V~, 50-60 HZ, 450W



**Ship Weight:** 11.7 lbs/5.3 kg

**Warranty:** 2 years parts & labor

#### 120V Specifications:

HBH450R  
120V~, 60 HZ, 6A



#### 230V Specifications:

HBH450-CE  
HBH450-UK  
HBH450-CCC  
220-240V~, 50-60 HZ, 600W



\* Input power

Turn to page 18 for our complete selection of Bar Blender accessories

# High-Performance Blenders

Improving high-volume efficiency

## HBH550



### Fury™ Blender 3 Hp motor

**Two Speeds plus Pulse** – Offer precision blending for a wide variety of drink mixtures.

**Timer with Automatic Shutoff** – Indispensable for busy bars, it frees operators up for other tasks.

**Powerful 3 HP motor** – Built with a durable all-metal drive coupling to satisfy the demands of the busiest bars.

**64oz/1.8L Jar** – Features patented Wave~Action® system for optimal blending performance.

## HBH650



### Tempest® Blender 3 Hp motor

**Two Speeds, Jump Cycle, and Pulse Button** – Offer precision blending for a wide variety of drink mixtures.

**Timer with Automatic Shutoff** – Indispensable for busy bars, it frees operators up for other tasks.

**Powerful 3 HP motor** – Built with a durable all-metal drive coupling to satisfy the demands of the busiest bars.

**64oz/1.8L Jar** – Features patented Wave~Action® system for optimal blending performance.

## HBH755



### Eclipse™ Blender 3 peak Hp\* motor

**Quiet Blend™ Technology** – Reduces motor noise and works with the Quiet Shield™ enclosure to lower sound to conversation level.

**Over 100 Pre-programmed Cycles** – Can be assigned to 5 buttons for popular drinks and additional cycles can be loaded via memory card.

**Sensors** – Equipped on the shield and jar pad (120V only) to extend life and ensure quiet operation.

**Powerful 3 HP Motor with Airflow Design** – Provides excellent blending results, helps prevent motor overheating, and extends motor life.

**64oz/1.8L Jar** – Features patented Wave~Action® system for optimal blending performance.



**Ship Weight:** 13.9 lbs/6.3 kg

**Warranty:** 3 years parts & labor (lifetime on motor drive coupling and blade)

#### 120V Specifications:

HBH550  
120V~, 60 HZ, 13A



#### 230V Specifications:

HBH550-CE  
HBH550-UK  
HBH550-CCC  
220-240V~, 50-60 HZ, 880W



**Ship Weight:** 13.9 lbs/6.3 kg

**Warranty:** 3 years parts & labor (lifetime on motor drive coupling and blade)

#### 120V Specifications:

HBH650  
120V~, 60 HZ, 13A



#### 230V Specifications:

HBH650-CE  
HBH650-UK  
HBH650-CCC  
220-240V~, 50-60 HZ, 880W



**Ship Weight:** 19.8 lbs/9 kg

**Warranty:** 3 years parts & labor (lifetime on motor drive coupling and blade)

#### 120V Specifications:

HBH755  
120V~, 60 HZ, 8.6A



#### 230V Specifications:

HBH755-CE  
HBH755-UK  
HBH755-CN  
220-240V~, 50-60 HZ, 1000W

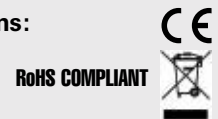

**With our high-performance blenders,** it's easy to achieve optimum results every time you blend. From convenient timers with automatic shutoff to advanced one-touch cycles, they have everything you need for maximum blending control and efficiency. To reduce noise, consider one with a sound enclosure — it will provide amazing power, yet it won't interrupt conversations.

## HBH850



### Summit® Blender with Auto Blend

**Auto Blend Technology** – Continuously monitors blender's power & speed to determine when the perfect drink consistency is reached.

**Quiet Shield™ Enclosure** – Reduces noise.

**Over 100 Pre-programmed Cycles** – Can be assigned to 4 buttons; additional cycles can be loaded via USB.

**Sensors** – Equipped on shield (230V only) and jar pad (120V only) to extend life and ensure quiet operation.

**Powerful 3 HP Motor** – Features a rear airflow baffle design that helps prevent motor overheating and extends motor life.

**64oz/1.8L Jar**

## HBH950



### Quantum® Blender with Endura™ Motor

**Endura™ Brushless Motor** – Provides next-generation, high-performance blending and is engineered to last 10 times longer and operate 50% more efficiently than its peers.

**One of the Quietest Blenders in the World** – Quiet Shield™ sound enclosure and advanced Endura™ motor ensure a quiet ambiance.

**Pre-loaded with 10 Languages** – For ease of use by operators in a wide variety of countries.

**One-Touch Blending Functions** – Select from over 30 cycles; new ones can be downloaded via USB.

**Best Motor Warranty in the Industry** – 7 years parts and labor on motor.

**64oz/1.8L Jar**

## ACCESSORIZE

### BCR100 Container Rinser

Save time and conserve water. A gentle push on the platform rinses jars up to 64 oz. / 1.8 L.



### 6126-751 AirWhip Frothing Jar

Quickly creates perfect milk foam and emulsifies dressings and sauces



**Ship Weight:** 23.3 lbs/10.6 kg

**Warranty:** 3 years parts & labor (lifetime on motor drive coupling and blade)

#### 120V Specifications:

HBH850  
120V~, 60 HZ, 13A



#### 230V Specifications:

HBH850-CE  
HBH850-UK  
HBH850-CCC  
220-240V~, 50-60 HZ, 880W



**Ship Weight:** 24.5 lbs/11.1 kg

**Warranty:** 7 years parts & labor on motor, 3 years parts & labor on rest of blender (lifetime on motor drive coupling and blade)

#### 120V Specifications:

HBH950  
120V~, 60 HZ, 10A



#### 230V Specifications:

HBH950-CE  
HBH950-UK  
HBH950-CN  
220-240V~, 50-60 HZ, 4.5A



Turn to page 21  
for our complete  
selection of High  
Performance Blender  
jars and accessories

\* Input power

# Beverage Automation

Taking automation to the next level

## HBS1400/HBS1200



### Revolution® Ice Shaver/Blender 5 gallon / 19L ice capacity

**Revolution® Portion System** – For maximum accuracy, the ice portioning system counts the number of times the agitator passes the shaver blade. Regardless of the motor load, the correct amount of ice comes out every time.

**Double-Wall Hopper** – Insulated for quiet operation and to keep ice cold.

**Sensor Technology** – Hopper sensor prevents operation when lid is not in place. Drain sensor indicates if water is backed up in the drain.

**Powerful 3 Hp Motor** – Heavy-duty and built to satisfy the demands of the busiest bars.

**Automatic Cycle Buttons** – Lets operators select serving size and number of servings for precise results.

**64oz/1.8L Jar with Wave-Action® System** – Provides optimal blend performance.

## COT2000



### PrimePour® Cocktails on Tap

**Speed** – Pouring a cocktail in seconds means less wait time for customers and increased sales.

**Ease of Use** – A pull of the tap blends spirits perfectly with B.I.B. cocktail mixes to make high-quality drinks every time.

**Portion and Quality Control** – The exact calibration of mix and spirit offers a consistent taste profile.

**Designer Tap Towers** – Eye-catching single or double towers with convenient drip tray for a neat bartop.

**Simple Installation** – Platform slides onto bartop without tools and attaches to supply box underneath.

**Automatic Pump Shutoff When Mix is Empty** – Ensures that spirit is not wasted.

**Slide-Out Bottle Tray** – Holds three 1 liter (750ml) bottles and makes refilling easy.



**Ship Weight:** 71 lbs/32.2 kg

**Warranty:** 2 years parts & labor (lifetime on motor drive coupling and blade)

**HBS1400  
120V Specifications:**  
120V~, 60 HZ, 15A



**HBS1200  
230V Specifications:**

HBS1200-CE  
HBS1200-UK  
HBS1200-CCC  
220-240V~, 50-60 HZ, 1000W



## DMC2000

### Drink Mix Container



This 2.5 gallon / 9.5 liter plastic container with quick connect fitting and hose presents another option for using cocktail mixes with the PrimePour™ unit.



**Ship Weight:** 84 lbs/38 kg

**Warranty:** Option to purchase up to 4 years

**CO2 Powered** (No electricity required)





**Whether you need a large batch of drinks or single servings by the cup,** we have the beverage automation solution that's right for you. By removing the possibility of inconsistency, these automation options are able to achieve perfection with every serving. Not only will you serve delicious drinks day after day, you'll save valuable time and labor year after year.

## BIC2000

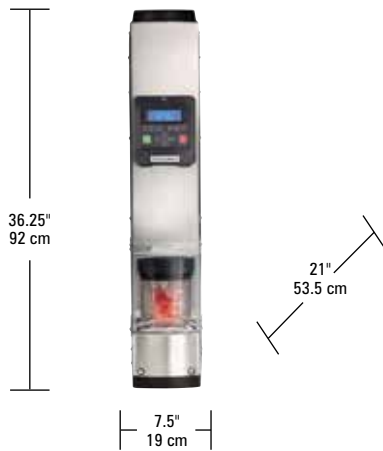

### SmartServe™

#### Blends in the cup

**Simple, Clean Process** – Just add ingredients to cup, insert cup in machine, and press start. It blends and stops automatically and the drink is ready to serve.

**Saves Ingredients and Time** – No more wasted ingredients in blender jar and it eliminates the step of emptying, cleaning, and storing jars.

**Saves Water** – Rinses with as little as 10 oz./300ml of water. It reduces water usage by 8 times compared to manual cleaning.

**Increases Productivity** – Staff can perform other tasks while the machine blends.

## MIC2000



### SmartServe™

#### Self-serve or crew-serve convenience

#### Mixes Milk Shakes or Incorporates

**Mix-Ins** – Makes it easy for customers or crew members to mix treats.

**Simple, Clean Process** – Just add ingredients to cup, insert cup in machine, and press start. It mixes and stops automatically and the treat is ready to serve.

**Can Add Water Automatically While Blending** – Helps ingredients blend efficiently.

**Saves Water** – Rinses with as little as 10 oz./300ml of water. It reduces water usage by 8 times compared to manual cleaning.

**Increases Productivity** – Staff can perform other tasks while the machine blends.

## BIC3000



### SmartServe™

#### Mixes small to extra-large cups

#### Mixes Milk Shakes or Incorporates

**Mix-Ins** – Makes it easy for customers or crew members to mix treats.

**Simple, Clean Process** – Just add ingredients to cup, insert cup in machine, and press start. It blends and stops automatically and the drink is ready to serve.

**Rotating Cup Holder** – Automatically rotates cup as it mixes for evenly mixed treats.

**Saves Water** – Rinses with as little as 10 oz./300ml of water. It reduces water usage by 8 times compared to manual cleaning.

**Increases Productivity** – Staff can perform other tasks while the machine blends.



**Ship Weight:** 103 lbs/47 kg

**Warranty:** 1 year parts & labor

#### 120V Specifications:

BIC2000  
120V~, 60 HZ, 3A



#### 230V Specifications:

BIC2000-CE  
BIC2000-UK  
220-240V~, 60 HZ, 2A

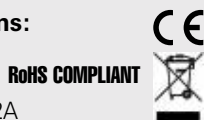

**Ship Weight:** 103 lbs/47 kg

**Warranty:** 1 year parts & labor

#### 120V Specifications:

MIC2000  
120V~, 60 HZ, 3A



#### 230V Specifications:

MIC2000-CE  
MIC2000-UK  
220-240V~, 50-60 HZ, 2A



**Ship Weight:** 105 lbs/48 kg

**Warranty:** 1 year parts & labor

#### 120V Specifications:

BIC3000  
120V~, 60 HZ, 6.2A



#### 230V Specifications:

BIC3000-CE  
BIC3000-UK  
220-240V~, 50-60 HZ, 2A



# Drink Mixers

Mixing perfect shakes since 1911

## HMD200



### Single Spindle

Mixes one shake

**Versatile Drink and Food Prep** – Great for everything from mixing shakes and “flashing” bar drinks to blending eggs and batters.

**Excellent Mixing Performance** – Powerful 1/3 Hp precision motor is balanced to minimize vibration and is built to last with sealed, permanently lubricated ball bearings. Operator can easily replace motor in minutes.

**Two-Way Motor Activation** – Operators can start and stop mixing action by inserting the cup into the cup guide, or by using the pulse switch on the top of the mixer.

**Easy to Clean** – Smooth housing made of stainless steel and die-cast aluminum. Cup guide removes for cleaning.

**Sealed Housing** – Eliminates the risk of water ingress and motor failure.

## HMD300



### Wall Mount

Saves space

**Saves Valuable Counter Space** – Fully featured in convenient wall-mount design, and plugs into standard outlet.

**Excellent Mixing Performance** – Powerful 1/3 Hp precision motor is balanced to minimize vibration and is built to last with sealed, permanently lubricated ball bearings. Operator can easily replace motor in minutes.

**Two-Way Motor Activation** – Operators can start and stop mixing action by inserting the cup into the cup guide, or by using the pulse switch on the top of the mixer (120V only).

**Easy to Clean** – Smooth housing made of stainless steel and die-cast aluminum.

**Sealed Housing** – Eliminates the risk of water ingress and motor failure.

## HMD400



### Triple Spindle

High-volume applications

**Ideal for High Volume** – All the features of the single spindle mixer with triple the volume.

**Excellent Performance** – Powerful 1/3 Hp motor for each spindle, each with its own controls.

**Precision Motor** – Balanced to minimize vibration and built to last with sealed, permanently lubricated ball bearings.

**Two-Way Motor Activation** – Operators can start and stop mixing action by inserting the cup into the cup guide, or by using the pulse switch on the top of the mixer.

**Easy to Clean** – Smooth housing made of stainless steel and die-cast aluminum. Cup guide removes for cleaning.

**Sealed Housing** – Eliminates the risk of water ingress and motor failure.



**Ship Weight:** 15.4 lbs / 7.0 kg  
**Warranty:** 1 year parts & labor

**120V Specifications:**  
HMD200  
120V~, 60 HZ, 300W



**230V Specifications:**  
HMD200P-CE  
HMD200P-UK  
HMD200P-CCC  
220-240V~, 50-60 HZ, 300W



**Ship Weight:** 10.5 lbs / 4.8 kg  
**Warranty:** 1 year parts & labor

**120V Specifications:**  
HMD300  
120V~, 60 HZ, 250W



**230V Specifications:**  
HMD300-CE  
HMD300-UK  
220-240V~, 50-60 HZ, 250W



**Ship Weight:** 37.6 lbs / 17.1 kg  
**Warranty:** 1 year parts & labor

**120V Specifications:**  
HMD400  
120V~, 60 HZ, 900W



**230V Specifications:**  
HMD400P-CE  
HMD400P-UK  
HMD400P-CCC  
220-240V~, 50-60 HZ, 900W



**We invented the first drink mixer over 100 years ago**, and we're still going strong today with our wide selection of world-class mixing machines. From timeless drink mixers to heavy-duty mixing machines, you'll get all the mixing control and power you need, whether you're preparing creamy milk shakes with hard ice cream or soft-serve creations with candy mix-ins.

## 94950



## HMD900



## ACCESSORIZE

### HMD300M Series Machine-Mount Drink Mixer

Specially designed to attach to soft-serve ice cream machines to add drink-making flexibility to your operation



### Mix 'n Chill® Heavy-duty mixing

**Dependability** – Ice cream companies and restaurateurs worldwide consider Mix 'n Chill to be the ideal choice because of its dependable performance.

**Variable Speed** – Rotary dial for flexibility and for ease of use.

**Powerful Mixing Performance** – 3/4 Hp motor provides heavy-duty mixing action.

**Heavy-Duty Metal Enclosure** – Meets commercial demands and provides durability.

**Easy Cleanup** – Stainless steel pan removes easily without the use of tools and is dishwasher safe. Splash shield easily removes for cleaning.

**Optional Foot Pedal** – For 120V only.

**Easy One-Hand Activation** – To start the motor, simply place the filled cup under the mixing shaft and push.

**Pre-programmed Cycles** – Deliver consistent mixing results regardless of the operator.

**Contoured Splash Shield** – Reduces discomfort on the operator's wrist.

**Powerful Mixing Performance** – 3/4 Hp motor provides heavy-duty mixing action.

**Heavy-Duty Metal Enclosure** – Meets commercial demands and provides durability.

**Easy Cleanup** – Stainless steel pan removes easily without the use of tools and is dishwasher safe. Splash shield easily removes for cleaning.

\* 230V version (not shown) meets IPX3 moisture protection with added hood

### 110E

#### Stainless Steel Cup

Holds 32 oz. (.95L) and is compatible with all drink mixers



### 928

#### Agitator

Compatible with all HBC drink mixers



### 929

#### Agitator

Compatible with all HBC drink mixers



Turn to page 20 for our complete selection of Drink Mixer accessories



**Ship Weight:** 37 lbs / 16.8 kg

**Warranty:** 1 year parts & labor

#### 120V Specifications:

94950

120V~, 60 HZ, 5.2A



**120V Ship Weight:** 33.6 lbs / 15.2 kg

**230V Ship Weight:** 38.3 lbs / 17.4 kg

**Warranty:** 1 year parts & labor

#### 120V Specifications:

HMD900

120V~, 60 HZ, 6.4A



#### 230V Specifications:

HMD900-CE

HMD900-UK

HMD900-CN

220-240V~, 50-60 HZ, 7A

RoHS COMPLIANT



# Expeditor™ Family of Culinary Blenders

## Creating the perfect blend for chefs

### HBF500



### HBF500S



### HBF600



## 500 Series

### 48oz. / 1.4L Jar

**Variable Speed & Pulse Functions** – Allow for easier blending, pureeing, grinding, chopping, and emulsifying.

**Chop Function** – Cycles between low speed and operator-selected high speed.

**1 Hp Motor** – Has the torque needed for chopping ingredients.

**Patented Wave~Action® Jar** – Keeps contents circulating through blades to ensure that contents are consistently incorporated.

**All-Metal Drive Coupling** – For durability.

**Large Dosing Cup** – Makes it easier to add liquid for emulsions while blending.

**Stainless Steel Blades** – Quickly cut through every ingredient.

### 64oz. / 1.8L Jar

**Variable Speed & Pulse Functions** – Allow for blending, pureeing, grinding, chopping, and emulsifying.

**Chop Function** – Cycles between low speed and operator-selected high speed.

**1 Hp Motor** – Has the torque needed for chopping ingredients.

**Stainless Steel Container** – Provides durability and features a comfortable, easy-to-grip handle.

**All-Metal Drive Coupling** – For durability.

**Large Dosing Cup** – Makes it easier to add liquid for emulsions while blending.

**Stainless Steel Blades** – Quickly cut through every ingredient.

## 600 Series

### 64oz. / 1.8L Jar

**Variable Speed & Pulse Functions** – Allow for easier blending, pureeing, grinding, chopping, and emulsifying.

**One-Touch Chop Function** – Cycles between low speed and operator-selected high speed.

**3 Hp Motor** – Provides the torque needed for effectively blending ingredients.

**Patented Wave~Action® Jar** – Keeps contents circulating through blades to ensure that contents are consistently incorporated.

**Large Dosing Cup** – Makes it easier to add liquid for emulsions while blending.

**Temperature Gauge** – Alerts operator if motor overheats while blending back-to-back batches.



**Ship Weight:** 11.3 lbs / 5.1 kg

**Warranty:** 2 years parts & labor

### 120V Specifications:

HBF500  
120V~, 60 HZ, 6A



### 230V Specifications:

HBF500-CE  
HBF500-UK  
HBF500-CCC  
220-240V~, 50-60 HZ, 600W



**Ship Weight:** 12.5 lbs / 5.9 kg

**Warranty:** 2 years parts & labor

### 120V Specifications:

HBF500S  
120V~, 60 HZ, 6.5A



### 230V Specifications:

HBF500S-CE  
HBF500S-UK  
HBF500S-CCC  
220-240V~, 50-60 HZ, 600W



**Ship Weight:** 14 lbs / 6.4 kg

**Warranty:** 3 years parts & labor (lifetime on motor drive coupling and blade)

### 120V Specifications:

HBF600  
120V~, 60 HZ, 13A



### 230V Specifications:

HBF600-CE  
HBF600-UK  
HBF600-CCC  
220-240V~, 50-60 HZ, 750W



**Ordinary blenders can't compete with Expeditor™ blenders** when it comes to culinary output and precision. From blending soups and sauces to emulsifying marinades and dressings, these culinary blenders help talented chefs around the world express their artistic vision. Even better, their intelligent controls and large capacities maximize speed-to-table so you can uphold impeccable service.

## HBF600S



**64oz. / 1.8L Jar**

**Variable Speed & Pulse Functions** – Allow for easier blending, pureeing, grinding, chopping, and emulsifying.

**One-Touch Chop Function** – Cycles between low speed and operator-selected high speed.

**3 Hp Motor** – Provides the torque needed for effectively chopping ingredients.

**Stainless Steel Container** – Provides durability and features a comfortable, easy-to-grip handle.

**Large Dosing Cup** – Makes it easier to add liquid for emulsions while blending.

**Temperature Gauge** – Alerts operator if motor overheats while blending back-to-back batches.

## HBF900S



### 900S Series

**1 gallon / 4L container**

**Heavy-Duty Construction** – Built for long-lasting performance in the world's busiest kitchens.

**Saves Prep Time** – With its powerful 3.5 HP motor and 1 gallon (4L) container, this blender is fully equipped to produce great results in a fraction of the time.

**Low-Profile Design** – Offers convenient access to container on any kitchen countertop. Also makes it easy to move the blender from one kitchen location to another.

**Easy-to-Use Controls** – 3 speeds plus pulse provide precision every time.

**Lid Interlock** – Ensures that the blender won't start until the jar and lid are securely in place.

**Transparent Lid and Dosing Cup** – Gives operators a clear view while blending.

## HBF1100S



### 1100S Series

**1 gallon / 4L container**

**Saves Prep Time** – Powerful 3.5 HP motor and large container help you finish blending jobs faster.

**Low-Profile Design** – For convenient access to the container on any countertop.

**Unique Chop Function** – Provides improved blending performance.

**Custom Program Buttons** – Offer a large degree of custom blending and precision control.

**Variable Speed Dial** – Allows blending from a very low speed to a high speed that quickly creates a smooth puree.

**Preset Timer Buttons** – Gives operators more time to perform other kitchen tasks.

**Lid Interlock** – Ensures that the blender won't start until the jar and lid are securely in place.



**Ship Weight:** 14.21 lbs / 6.5 kg

**Warranty:** 3 years parts & labor (lifetime on motor drive coupling and blade)

**120V Specifications:**

HBF600S  
120V~, 60 HZ, 13A



**230V Specifications:**

HBF600S-CE  
HBF600S-UK  
HBF600S-CCC  
220-240V~, 50-60 HZ, 750W



**Ship Weight:** 24.3 lbs/11 kg

**Warranty:** 3 years parts & labor (lifetime on motor drive coupling and blade)

**120V Specifications:**

HBF900S  
120V~, 60 HZ, 14A



**230V Specifications:**

HBF900S-CE  
HBF900S-UK  
HBF900S-CCC  
220-240V~, 50-60 HZ, 750W



**Ship Weight:** 24.3 lbs / 11 kg

**Warranty:** 3 years parts & labor (lifetime on motor drive coupling and blade)

**120V Specifications:**

HBF1100S  
120V~, 60 HZ, 14A



**230V Specifications:**

HBF1100S-CE  
HBF1100S-UK  
HBF1100S-CN  
220-240V~, 50-60 HZ, 1500W



# Back-of-the-House Equipment

Providing versatility and durability

## CPM800



### Stand Mixer

#### Powerful performance

**8 Quart (8 L) Capacity** – Small enough for the countertop, yet robust enough to handle any mixing job.

**Tilt-Back Head** – Makes it easy to add ingredients, scrape sides, change attachments, and remove the bowl.

**Stainless Steel Bowl with Handles** – Makes it easy to lift and carry contents.

**Heavy-Duty Attachments** – Stainless steel beater, dough hook & wire whisk with splash shields to keep ingredients away from the hub area.

**Variable 7 Speed Dial + Pulse** – Allows for speed changes while mixing.

**Sealed Stop/Start Buttons** – Easily respond to touch for ease of use.

## HMI200



### Immersion Blender

#### 9" shaft

**Stainless Steel 9"/23cm Shaft** – Not only does the thick 9"/23 cm shaft reach into deep pots and bowls, it detaches for easy cleaning.

**Flexibility** – Detachable blending attachment plus two speeds give professional kitchens the flexibility they need to purée soups and sauces right in the pan, whip egg whites, cream butters & mix batters with ease.

**Heavy Duty** – Long-life motor construction and stainless steel blending attachment designed for foodservice applications.

**Innovative Blade Guard** – Keeps prep areas neat and saves time by reducing messy splashing and clogging.

**Double-Insulated** – With two-conductor cord for easier use and storage.

## 37590



### Rice Cooker

#### 90 cup

**Extra-Large Capacity** – Lets you cook 90 cups of cooked rice (45 cups uncooked).

**Digital Control Panel** – Provides multiple cooking options and is easy to keep clean.

**Heat/Simmer Function** – Maintains the right temperature to help prevent boilover for up to 4 hours.

**Insulated Double-Wall Construction** – With hinged/heated lid that's easy to open and close.

**Nonstick Inner Pot with Handles** – Makes it easy to lift and carry contents.

**Condensation Cup** – Collects water to keep messy drips off countertops.

**Accessories Included** – Rice measuring cup and paddle.

Global Care ExpressCare U.S. ONLY

**Ship Weight:** 35 lbs / 25 kg  
**Warranty:** 2 years parts & labor

**120V Specifications:**  
CPM800  
120V~, 60 HZ, 800W/ 7A

**230V Specifications:**  
CPM800-CE  
CPM800-UK  
220-240V~, 50-60 HZ, 1500W, IPX2

ETL Intertek NSF  
CE RoHS COMPLIANT

Global Care ExpressCare U.S. ONLY

**Ship Weight:** 4.2 lbs / 1.9 kg  
**Warranty:** 1 year parts & labor

**120V Specifications:**  
HMI200  
120V~, 60 HZ, 175W

**230V Specifications:**  
HMI200-CE  
HMI200-UK  
HMI200-CCC  
220-240V~, 50-60 HZ, 175W

UL US NSF  
CE CCC RoHS COMPLIANT

Global Care ExpressCare U.S. ONLY

**Ship Weight:** 37.7 lbs / 16.2 kg  
**Warranty:** 1 year parts & labor

**240V Specifications:**  
37590  
240V~, 60 HZ, 2500W  
NEMA 6-15P type plug

ETL Intertek Conforms to NSF/ANSI Std. 8  
6-15P

**By saving valuable time and labor**, these versatile kitchen tools can help every commercial food operation improve their bottom line. From small shops to large restaurants, our hard-working tools are the ones to keep on hand when you need to mix cookie doughs or cake batters, prepare perfect rice, open cans, or serve food with consistent portion sizes.

## HCO500

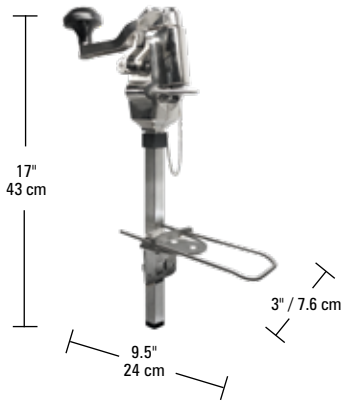

### Side-Cut Can Opener

**No more sharp edges**

**Opens Seam of Can** – Cans are opened on the side seam instead of puncturing the lid, so there's no sharp edges.

**No Cross Contamination** – No blade to make contact with food, unlike conventional can openers.

**No Risk of Metal Shavings** – Since the lid is not being cut with a blade, metal shavings won't get into the food.

**No Gears to Wear or Break** – Removes the possibility of downtime.

**Durable Construction** – Made of stainless steel and nickel-plated aluminum for durable performance.

## 78



### 78 Series Dishers

**Classic style**

**Portion Control** – Each of the 9 disher sizes lets you serve consistent portions every time. Choose from the smallest purple disher with 1-1/2" bowl diameter to the largest white disher with 3" bowl diameter.

**Color-Coded Handles** – Bright, identifiable colors make it easy to select the correct disher for improved service and correct portion sizes.

**Durable Stainless Steel** – The bowl, thumb lever, and spring are made of stainless steel for long life and easy cleanup in the dishwasher.

**Heavy-Duty Spring Action** – The heavy-duty stainless steel spring allows for ease of operation and long-lasting durability.

## 80



### 80 Series Dishers

**Deluxe style**

**80 series dishers have all the features of the 78 series shown left, plus these extras:**

**Pan Rest™ Feature** – These convenient notches in the handles let the dishers rest on the edge of pans to help prevent slippage that could slow down service.

**Ergonomic Grip** – Handles are shaped to create a comfortable grip, which helps reduce hand and arm fatigue.

**Imprinted Capacity** – Since the capacity of each disher is clearly molded onto the handle, there's never a question about which size disher is being used.



**Ship Weight:** Varies depending on size

**Warranty:** 1 year parts & labor (78 series) 2 years parts & labor (80 series)



**Ship Weight:** 4.5 lbs / 2 kg

**Warranty:** 2 years parts & labor



Color	Disher size	Bowl diameter	Milliliters*	Fluid oz.*	Fluid oz. fractional**	Wt./oz.*
○ White	6	3"	138	4.66	4¾"	4.86
○ Grey	8	2¾"	108	3.64	3¾"	3.80
○ Ivory	10	2⅝"	94	3.19	3¼"	3.33
● Green	12	2½"	82	2.78	2¾"	2.90
● Blue	16	2¼"	61	2.07	2"	2.16
● Yellow	20	2⅛"	52	1.77	1¾"	1.84
● Red	24	2"	44	1.49	1½"	1.56
● Black	30	1¾"	30	1.03	1"	1.07
● Orchid	40	1½"	20	0.68	¾"	0.70

\* Water capacity \*\* Approximate

# FreshMark™ Family of Juicers

Maximizing juice output

932



## Manual Citrus

Fills a glass of juice in less than a minute

**20-50 Glasses Daily** – Ideal for operations that serve up to 50 glasses of juice per day.

**Citrus Versatility** – Designed to extract juice from lemons, limes, oranges, and grapefruits.

**Maximum Juice Extraction** – Exerts up to 2000 lbs. of force to ensure maximum juice output.

**Acid-Resistant Finish** – Resists wear and tear from exposure to citrus acids.

**Stainless Steel Strainer Cone** – Removes for easy cleaning in the dishwasher.

**5.5" Cup Clearance** – Provides ample room to place an 8-10 oz. cup underneath for juicing.

**Sure Grip™ Feet** – Keep the juicer firmly in place.

HCJ967



## Electric Citrus

Fills a glass of juice in less than 30 seconds

**100+ Glasses Daily** – For operations that serve up to 100 glasses of juice per day.

**Citrus Versatility** – Designed to extract juice from lemons, limes, oranges, and grapefruits.

**Exceptionally Quiet** – The brushless induction motor is barely audible, so operators can more easily focus on customers.

**Heavy-Duty Construction** – Designed to withstand continuous juicing. Die-cast aluminum base makes the juicer less prone to tipping over.

**3 Metal-Reinforced Reamers** – Maximize juice output from small to large citrus fruits.

**Stainless Steel Juice Bowl** – Removes for easy cleaning.

**Extra-Tall (8.5"/21.6cm) Spout** – Accommodates everything from small juice glasses to large pitchers.



**Ship Weight:** 13.2 lbs / 6 kg  
**Warranty:** 1 year parts & labor



**Ship Weight:** 30 lbs / 13.6 kg  
**Warranty:** 2 years parts & labor

### 120V Specifications:

HCJ967  
120V~, 60 HZ, 3A



### 230V Specifications:

HCJ967-CE  
HCJ967-UK  
HCJ967-CN  
220-240V~, 50-60 HZ, 250W





**We've built commercial-quality juicers since 1932**, when our 932 manual juicer first made its mark. Today the FreshMark™ family of commercial juicers offers businesses the maximum output they need in order to keep the juice flowing. Whether you run a juice shop, bar, supermarket, or a chain of restaurants, each one is expertly designed to offer you excellent juicing performance you can count on every single day.

## HWG800



### Wheatgrass

Extracts up to 5 oz./150ml per minute

**Versatile Extraction** – Designed to extract juice from wheatgrass, ginger, and leafy herbs.

**Powerful, High-Torque Motor** – Provides optimal juice extraction for maximum yield.

**Durable Construction** – Solidly built for rigorous professional use with stainless steel components and permanently lubricated, air-cooled motor.

**Surgical-Grade Internal Assembly** – Top-quality 304 surgical grade stainless steel parts provide long life.

**Removable Food Zone Parts** – Can be quickly removed for fast, easy cleaning.

**Convenient Toggle Switch** – Includes a reverse option for cleaning after extracting dry herbs and sprouts.

**Maintenance Kit Included** – Comes with 2 metal screens and two gaskets.

## HJE960



### otto™ The Juice Extractor

Extracts approximately 2 qts. / 2L per minute

**100+ Glasses Daily** – For operations that require large yields of juice from a variety of produce and/or serve 100 or more glasses of juice per day.

**Centrifugal Extraction** – Extracts juice from apples, carrots, cucumbers, celery, red beets, ginger, leafy greens, and more.

**Powerful Brushless Induction Motor** – Provides quiet operation and has dual cooling fans for continuous juicing.

**Heavy-Duty Die-Cast Base** – Provides exceptional durability and keeps juicer sitting securely on the countertop.

**3" (76cm) Feed Chute Opening** – Minimizes prep time.

**Simple Single-Speed Operation** – For effortless juicing.

**Top-Quality Parts** – Stainless steel and BPA-free parts provide exceptional durability and are easy to clean.

**Heavy-Duty Metal Handle** – withstands repeated opening and closing and stops motor before lid can be opened.



**Ship Weight:** 37 lbs / 17 kg  
**Warranty:** 1 year parts & labor

#### 120V Specifications:

HWG800  
120V~, 60 HZ, 375W



E302938 Conforms to  
ANSI/NFS8 NSF/ANSI Std 8



**Ship Weight:** 75.6 lbs / 34.3 kg  
**Warranty:** 2 years parts & labor

#### 120V Specifications:

HJE960  
120V~, 60 HZ, 8.5A



#### 230V Specifications:

HJE960-CE  
HJE960-UK  
HJE960-CN (50 mm feed chute)  
220-240V~, 50-60 HZ, 1200W



RoHS COMPLIANT



Passes IPX1 water rating

# PrimaVac™ Family of Vacuum Packaging

Preserving food's freshness and flavor

## HVS400R

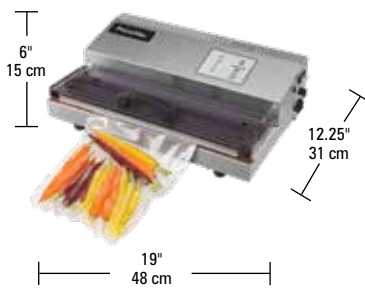

### PrimaVac™ External

16" (406 mm) seal bar

**One-Touch Operation** – Automatically sequences machine from vacuuming to sealing to releasing.

**16" (40.6cm) Seal Bar** – For sealing wide bags or two smaller bags at once.

**LED lights** – Indicate each vacuuming stage.

**Powerful Double-Piston Pump** – For fast vacuuming.

**Durable Stainless Steel Housing** – Ensures long-lasting beauty and is easy to clean.

**Optional Manual Mode** – Perfect for using rolls or for sealing soft foods.

**Transparent Lid** – For easy bag alignment.

## HVC254



### PrimaVac™ In-Chamber

10" (254 mm) seal bar

**10 Custom Programs** – Let you adjust vacuuming and sealing times for different needs and recipes.

**Powerful JetAire™ 8 m3/h Vacuum Pump** – Provides robust, long-lasting service.

**Adjustable Soft Air** – Protects delicate food.

**Adjustable Sealing and Cooling Time** – Lets you customize sealing action to your exact preference and applications.

**Oil Change Reminder** – Helps ensure that you maintain a top-functioning pump.

**Durable Stainless Steel Housing** – Ensures long-lasting beauty and is easy to clean.

**Accessories and Power Cords Included** – Comes with 80 pouches, filler plate, tools, and electrical cords for UK, Continental Europe, and China.

## HVC305



12" (305 mm) seal bar

**10 Custom Programs** – Let you adjust vacuuming and sealing times for different needs and recipes.

**Powerful JetAire™ 12 m3/h (120V), 10 m3/h (230V) Vacuum Pump** – Provides robust, long-lasting service.

**Adjustable Soft Air** – Protects delicate food.

**Adjustable Sealing and Cooling Time** – Lets you customize sealing action to your exact preference and applications.

**Oil Change Reminder** – Helps ensure that you maintain a top-functioning pump.

**Durable Stainless Steel Housing** – Ensures long-lasting beauty and is easy to clean.

**Accessories and Power Cords Included** – Comes with 80 pouches, filler plate, tools, and electrical cords for UK, Continental Europe, and China.



**Ship Weight:** 26 lbs/11.8 kg

**Warranty:** 1 year parts & labor

**120V Specifications:**

HVS400R

120V~, 60 HZ, 1020W



**Ship Weight:** 80 lbs/36.3 kg

**Warranty:** 2 years parts & labor; 3 years with product registration

**HVC254**

**120V Specifications:**

120V~, 60 HZ, 300 Watts, 3A



**HVC254-CE**

**220V Specifications:**

220-240V~, 50-60 HZ, 350W



**RoHS COMPLIANT**



**Ship Weight:** 94 lbs/42.6 kg

**Warranty:** 2 years parts & labor; 3 years with product registration

**HVC305**

**120V Specifications:**

120V~, 60 HZ, 5A



**HVC305-CE**

**220V Specifications:**

220-240V~, 50-60 HZ, 350W



**RoHS COMPLIANT**

**With PrimaVac™ vacuum packaging machines,** commercial kitchens can accomplish a wide variety of tasks, from preserving food's freshness to giving chefs the ability to prep dishes for sous vide. Along with our selection of PrimaVac™ machines, we also offer an external vacuum sealer for smaller applications and a sous vide immersion circulator.

## HVC406



### 16" (406 mm) seal bar

**Gas Flush** – Creates a protective cushion to keep food from being crushed.

**10 Custom Programs** – Let you adjust vacuuming and sealing times for different needs and recipes.

**Powerful JetAire™ 24 m3/h (120V), 20 m3/h (230V) Vacuum Pump** – Provides robust, long-lasting service.

**Adjustable Soft Air** – Protects delicate food.

**Adjustable Sealing and Cooling Time** – Lets you customize sealing action to your exact preference and applications.

**Oil Change Reminder** – Helps ensure that you maintain a top-functioning pump.

**Accessories and Power Cords Included** – Comes with 80 pouches, filler plate, tools, and electrical cords for UK, Continental Europe, and China.

## HSV1000



### AcuVide™ 1000 Sous Vide Circulator

**1200 Watt Water Heater** – Keeps up to 8 gallons (30L) of water at an even, consistent temperature for uniform cooking.

**IPX7 Construction** – Prevents malfunction if accidentally dropped in water.

**Adjustable Timer with Easy-to-Read Display** – Select up to 99 hours of sous vide time and set water temperature in your choice of Fahrenheit or Celsius.

**Stainless Steel Lower Housing** – Removes for easy cleaning.

**Cleaning Cycle and Reminder** – Helps keep the circulator in top performance.

**Water Level Marks and Warning Signal** – Help unit run uninterrupted.

**Adjustable Clamp** – Allows for best placement in vessel and secures without tools.

## ACCESSORIZE

Equip your kitchen with the vacuum sealer pouches and bags your staff needs for food storage and sous vide applications.

### In-Chamber Sealer Pouches

- FDA-approved for temperatures above 121 °C (249 °F)
- Made of 9 layers of smooth PA and PE for oxygen barrier and puncture protection
- Available in 3 and 4 mil thicknesses



### External Vacuum Sealer Bags

- Heavy-duty embossed bags for efficient air removal and airtight seal
- BPA-free and FDA-approved for storage
- Available in 3 sizes in 3 mil thickness

**NSF** See next page for complete selection of bags and pouches



**Ship Weight:** 190 lbs/86 kg

**Warranty:** 2 years parts & labor; 3 years with product registration

#### HVC406

**120V Specifications:**  
120V~, 60 HZ, 10A



#### HVC406-CE

**220V Specifications:**  
220-240V~, 50-60 HZ, 850W



**Ship Weight:** 4 lbs/2 kg

**Warranty:** 1 year parts & labor

#### 120V Specifications:

HSV1000  
120V~, 60 HZ, 1200W



#### 230V Specifications:

HSV1000-CE  
HSV1000-UK  
220-240V~, 50-60 HZ, 1200W



## Vacuum Packaging Pouches and Bags

<b>PrimaVac</b>	<b>Width IN/MM</b>	<b>Length IN/MM</b>	<b>Mil/ Microns</b>	<b>Count per Case</b>
<b>In-Chamber 3 MIL</b>	3 mil is the standard thickness for storing, freezing, or boiling food in individual servings or large quantities.			
HVCP30608	6 / 152	8 / 203	3 MIL / 75 $\mu$ m	1000
HVCP30610	6 / 152	10 / 254	3 MIL / 75 $\mu$ m	1000
HVCP30810	8 / 203	10 / 254	3 MIL / 75 $\mu$ m	1000
HVCP30812	8 / 203	12 / 305	3 MIL / 75 $\mu$ m	1000
HVCP31013	10 / 254	13 / 330	3 MIL / 75 $\mu$ m	1000
HVCP31015	10 / 254	15 / 381	3 MIL / 75 $\mu$ m	1000
HVCP31214	12 / 305	14 / 335	3 MIL / 75 $\mu$ m	1000
HVCP31216	12 / 305	16 / 406	3 MIL / 75 $\mu$ m	500
<b>In-Chamber 4 MIL</b>	4 mil provides extra protection against tears from bones or sharp contents.			
HVCP40610	6 / 152	10 / 254	4 MIL / 100 $\mu$ m	1000
HVCP40810	8 / 203	10 / 254	4 MIL / 100 $\mu$ m	1000
HVCP40812	8 / 203	12 / 305	4 MIL / 100 $\mu$ m	1000
HVCP41013	10 / 254	13 / 330	4 MIL / 100 $\mu$ m	1000
HVCP41214	12 / 305	14 / 335	4 MIL / 100 $\mu$ m	1000
<b>In-Chamber Retherm</b>	Retherm pouches are available in 3 or 4 mil. and feature reinforced corners that help the bags withstand exposure to heat.			
HVCPR30812	8 / 203	12 / 305	3 MIL / 75 $\mu$ m	1000
HVCPR31015	10 / 254	15 / 381	3 MIL / 75 $\mu$ m	1000
HVCPR41216	12 / 305	16 / 406	4 MIL / 100 $\mu$ m	500
<b>External Vacuum Bags</b>	Bags are for use with external vacuum sealers and are designed to create a secure seal that locks out air and moisture.			
HVBX1000	6 / 152	10 / 254	3 MIL / 75 $\mu$ m	100
HVBX1100	8 / 203	12 / 305	3 MIL / 75 $\mu$ m	100
HVBX1200	11 / 280	16 / 406	3 MIL / 75 $\mu$ m	100

# Global Warranty Coverage



Hamilton Beach Commercial® stands behind its products, and our global warranty coverage and customer service are second to none. If you ever have an issue, we provide fast, friendly service that's available when you need it.

## FOR OUR U.S. CUSTOMERS:



For qualifying products, follow this easy 3 step process:

1. Dial 1-866-285-1087 to speak to a member of our highly trained technical services staff (M-F 8am-5pm EST). We will make an initial phone diagnosis.
2. If it is determined that minimal on-site maintenance cannot be performed, Hamilton Beach Commercial® will ship a replacement product to your location.
3. Once the replacement unit is received, you send the troubled unit back to Hamilton Beach Commercial® (we will provide the box and supporting materials to return the unit and we pay the freight cost for the returned unit).

For all other products, please call 1-866-285-1087 to receive assistance on your parts and labor warranty.

Note: Limitations and exclusions apply. Express Care is only available to end users located in the continental US, Alaska and Hawaii.

## FOR OUR GLOBAL CUSTOMERS:



We have a network of highly trained service companies in over 60 countries worldwide.

We provide 24/7/365 support via our dedicated technical services website which includes:

- detailed troubleshooting and repair instructions
- drawings with exploded view
- recommended parts lists
- registered service centers by country
- operation manuals and agency certifications

Our technical services team, based in North Carolina USA, offers a variety of training options, including web-based training.

Visit us at:

[hamiltonbeachcommercial.com](http://hamiltonbeachcommercial.com) to find your country service provider, contact us directly at \*1-910-693-4277 or send an email to: [commercial.support@hamiltonbeach.com](mailto:commercial.support@hamiltonbeach.com).

# Accessories

## Bar Blenders

### 6126-HBB908 (120V), 6126-HBB908-CE (230V)

HBB908 series 44 oz. /  
1.25 L polycarbonate  
container



### 6126-HBB909 (120V), 6126-HBB909-CE (230V)

HBB908 series and HBB909  
32 oz. / .95 L stainless steel  
container assembly



### 98908

Cutter assembly, clutch and  
gasket for models 908, 909  
and older bar blenders



### 6126-250 (120V), 6126-250-CE (230V)

Rio 44 oz. / 1.25 L  
polycarbonate container  
assembly for HBB250  
series



### 6126-250S (120V), 6126-250S-CE (230V)

Rio 32 oz. / .95 L stainless  
steel container assembly for  
HBB250S series



### 98250

Rio blender repair kit.  
Cutter assembly, clutch, and  
gasket for models HBB250  
and HBB250S series



### 6126-450 (120V), 6126-450-CE (230V)

Tango 48 oz / 1.4 L  
polycarbonate container  
assembly for HBH450R and  
HBH450 series



### 98450

Tango blender repair kit  
with complete cutting  
assembly, clutch, and  
retainer nut for HBH450  
series



## Back-of-the-House Equipment

### BW800SS

Stainless steel 8 quart / 8 L  
bowl with handles for  
CPM800 series stand mixer



### WW800SS

Stainless steel wire whisk for  
CPM800 series stand mixer



### DH800SS

Stainless steel flat beater for  
CPM800 series stand mixer



### FB800SS

Stainless steel flat beater for  
CPM800 series stand mixer



## Commercial Juicers

### HMIA200B

Immersion mixer chopping attachment for HMI200 series



### CH500

Replacement cutter housing for HCO500 side-cut can opener



### UTC960

Under-the-counter pulp bin for HJE960 otto juice extractor series



### SB961

Stainless steel replacement strainer juice basket and blade for HJE960 otto juice extractor series



## High-Performance Blenders

### 6126-600

Fury, Tempest, and Summit 48 oz. / 1.4 L polycarbonate container assembly for HBH550, HBH650 and HBH850 series blenders



### 6126-650

Fury, Tempest, and Summit 64 oz. / 1.8 L polycarbonate container assembly for HBH550, HBH650 and HBH850 series blenders



### 6126-750

Eclipse 48 oz. / 1.4 L polycarbonate container assembly for HBH750 series blenders



### 6126-755

Eclipse 64 oz. / 2 L polycarbonate container assembly for HBH755 series blenders



### 6126-950

Quantum 64 oz. / 1.8 L polycarbonate container assembly for HBH950 series blender



### 98650

Tempest, Summit, Revolution & Eclipse blender repair kit with cutter assembly, clutch, gasket, and retainer nut for HBH650 series, HBH755 series, HBH850 series, HBF600/HBF600S series, and HBS1400



### BT650

Tamper for Fury and Tempest series blenders



### CK650

In-counter kit allows the Tempest HBH650 series to be mounted in counter



### JP750

Alternate jar pad can be used on Fury HBH550, Tempest HBH650, Eclipse HBH755, Summit HBH850, and Expeditor HBF600



## Drink Mixers

### Agitators

Adds mixing flexibility and functionality to drink mixers HMD200, HMD300, HMD400, 94950, and HMD900 series

**927**



For omelettes, batter, and frothing

**928**



For gently mixing

**929**



For mix-ins and hard ice cream

**930**



For hard ice cream\*

**931**



For mix-ins\*

\*94950 and HMD900 series only

**110E**

Universal 32 oz. / .95 L stainless steel container for all drink mixers by Hamilton Beach Commercial



## Culinary Blenders

**990156300 (120V)/  
990156400 (230V)**

Replacement motor kit for HMD200 and HMD400 series drink mixers



**6126-HBF500-CE**

Expeditor 48 oz. / 1.4 L polycarbonate container assembly for HBF500 series blenders (120V & 230V models)



**6126-400-CE**

Expeditor 64 oz. / 1.8 L stainless steel container assembly for HBF500S series blenders (120V & 230V models)



**6126-HBF600**

Expeditor 64 oz. / 1.8 L polycarbonate container assembly for HBF600 series blenders



**6126-HBF600S**

Expeditor 64 oz. / 1.8 L stainless steel container assembly for HBF600 series blenders



**6126-1100S**

Expeditor 1 gallon / 4 L stainless steel container assembly for HBF900S and HBF1100S series blenders



**6126-1100**

Expeditor 1 gallon / 4 L polycarbonate jar; fits both HBF900S and HBF1100S series blenders





## Culinary Blenders

### 98400

Expeditor food blender repair kit with cutter assembly, clutch, gasket, and retainer nut for HBF500S series



### 98500

Expeditor food blender repair kit with cutter assembly, clutch, gasket, and retainer nut for HBF500



### 981100

Expeditor cutter assembly, clutch, gasket, and retainer nut for HBF1100



### 981100S

Expeditor cutter assembly, clutch, gasket, and retainer nut for HBF900S and HBF1100S series



## Vacuum Packaging

### FP254

Filler plate for HVC254 series chamber machine



### FP305

Filler plate for HVC305 series chamber machine



### FP406

Filler plate for HVC406 series chamber machine



### SB254

Seal bar assembly for HVC254 series chamber machine

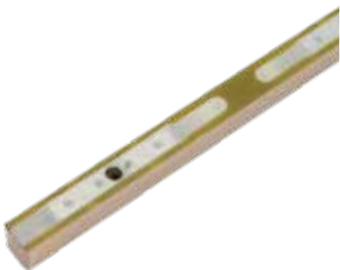

### SB305

Seal bar assembly for HVC305 series chamber machine

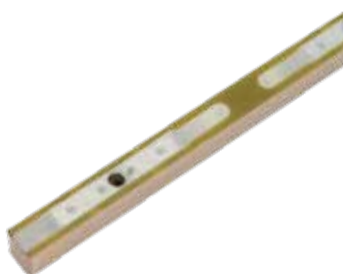

### SB406

Seal bar assembly for HVC406 series chamber machine

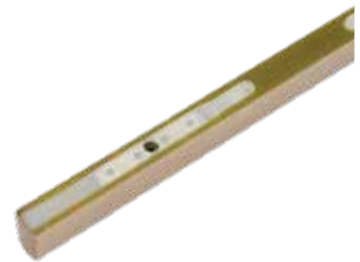

## 55000

## 66900 series

# Tested. Proven.®

From preparing perfect rice to serving coffee to a crowd, Proctor Silex® Commercial products give culinary professionals the reliable performance they need to get the job done right. To make sure we deliver on this promise, our products are rigorously life-tested for exceptional durability. Each design has to prove itself worthy thousands of times in our testing labs before it ever reaches your commercial kitchen. It's the reason Proctor Silex® Commercial can confidently say that every equipment investment you make with us pays off with performance you can rely on.



### High-Performance Blender

2.4 Hp motor

Excellent for both drinks and food, including smoothies, drinks, salsa, hummus, and dressings

Powerful 2.4 peak\* hp motor

Large 64 oz. / 1.8 L BPA free blending jar

Durable stainless steel blades

Includes tamper for thick mixtures

\*Peak input power



### Citrus Juicer

3 Reamers

3 reamer sizes for juicing oranges, lemons, limes, and grapefruits

Quiet, durable induction motor quickly finishes every juicing task

Ample height for juicing into tall cups

Heavy-duty aluminum housing

Removable bowl, strainer, splash guard, and drip tray for easy cleaning

Passes IPX1 water ingress testing



**Ship Weight:** 15.3 lbs / 6.9 kg

**Warranty:** 1 year

**120V Specifications:**

Model 55000  
120V~, 60 HZ, 12.5 A



**Ship Weight:** 14.7 lbs / 6.7 kg

**Warranty:** 1 year

**120V Specifications:**

Model 66900  
120V~, 60 HZ, 160W



**230V Specifications:**

66900-CE  
66900-UK  
220-240V~, 50-60 HZ, 150W

**RoHS COMPLIANT**



# Beverage

## 45040R



### Coffee Urn

**40** Cup Capacity

Durable, yet lightweight aluminum construction with brushed finish

Simple one-hand dispensing

Keep warm heater maintains coffee's optimal temperature

Tall base makes it easy to fill both large and small cups

## 45060R



### Coffee Urn

**60** Cup Capacity

Durable, yet lightweight aluminum construction with brushed finish

Simple one-hand dispensing

Keep warm heater maintains coffee's optimal temperature

Tall base makes it easy to fill both large and small cups

## 45100R



### Coffee Urn

**100** Cup Capacity

Durable, yet lightweight aluminum construction with brushed finish

Simple one-hand dispensing

Keep warm heater maintains coffee's optimal temperature

Tall base makes it easy to fill both large and small cups



**Ship Weight:** 6.8 lbs / 3.1 kg

**Warranty:** 1 year

#### 120V Specifications:

Model 45040R  
120V~, 60 HZ, 1090W



**Ship Weight:** 7.3 lbs / 3.3 kg

**Warranty:** 1 year

#### 120V Specifications:

Model 45060R  
120V~, 60 HZ, 1090W



**Ship Weight:** 8.8 lbs / 3.9 kg

**Warranty:** 1 year

#### 120V Specifications:

Model 45100R  
120V~, 60 HZ, 1090W



# Food Prep

## 37540 series



### Rice Cooker/Warmer

**40** Cup capacity

- Shifts to keep warm after cooking
- Easy-to-clean nonstick pot
- Hinged lid is easy to open and close
- Cooks white, brown, jasmine, and basmati rice
- Durable stainless steel housing
- 40 cup (9 liter) capacity

## 37560R series



### Rice Cooker/Warmer

**60** Cup capacity

- Insulated double-wall construction with heated/hinged lid
- Shifts to keep warm after cooking
- Easy-to-clean nonstick pot
- Cooks rice, grits, oatmeal, porridge, mac-and-cheese
- Durable stainless steel housing
- 60 cup (14 liter) capacity

## 78450



### Dehydrator

**10** Trays

- Convenient slide-up door eliminates the need to handle a hot door
- 10 removable trays provide 16 square feet of drying surface
- Horizontal airflow fan system and 1200 watts of power for thorough, even drying
- 7 temperature settings and digital timer for up to 15 hours
- Durable, all-stainless-steel construction is easy to clean



**Ship Weight:** 15.4 lbs / 7 kg

**Warranty:** 1 year

#### 120V Specifications:

Model 37540  
120V~, 60 HZ, 1250W



#### 230V Specifications:

37540-CE  
37540-UK  
220-240V~, 50-60 HZ, 1250W



**Ship Weight:** 25.4 lbs / 11.5 kg

**Warranty:** 1 year

#### 120V Specifications:

Model 37560R  
120V~, 60 HZ, 1550W



#### 230V Specifications:

37560R-CE  
37560R-UK  
220-240V~, 50-60 HZ, 1950W



**Ship Weight:** 38 lbs / 17.3 kg

**Warranty:** 1 year

#### 120V Specifications:

Model 78450  
120V~, 60 HZ, 1200W



# Food Prep

22850



## Toaster

2 Slots

- Extra-wide 1.5" slots
- Convenient bagel function
- Longer-life heating elements
- Automatic toast boost
- Front crumb tray for fast, easy cleanup
- Durable brushed chrome

24850

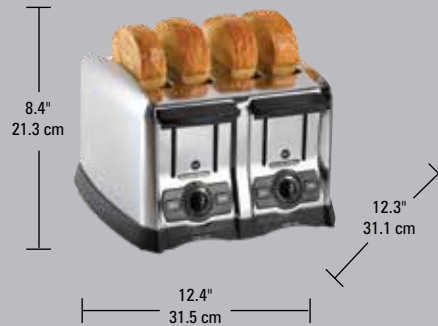

## Toaster

4 Slots

- Extra-wide 1.5" slots
- Convenient bagel function
- Longer-life heating elements
- Automatic toast boost
- Front crumb tray for fast, easy cleanup
- Durable brushed chrome

32920



## Roaster Oven/Warmer

18 Quart capacity

- Fits a 24 lb. turkey
- Cooks, warms, roasts, and bakes
- Temperature adjusts from 200° - 450° F
- Includes removable pan and lift-out rack
- Durable stainless steel construction
- Commercially rated



**Ship Weight:** 5.2 lbs / 2.4 kg

**Warranty:** 1 year

### 120V Specifications:

Model 22850  
120V~, 60 HZ, 1000W



**Ship Weight:** 7.7 lbs/ 3.5 kg

**Warranty:** 1 year

### 120V Specifications:

Model 24850  
120V~, 60 HZ, 1650W



**Ship Weight:** 16.4 lbs / 7.4 kg

**Warranty:** 1 year

### 120V Specifications:

Model 32920  
120V~, 60 HZ, 1440W



4421 Waterfront Drive • Glen Allen, Virginia 23060 • 1-800-572-3331 (US) or + 1-910-963-4277  
hamiltonbeachcommercial.com







4421 Waterfront Drive • Glen Allen, Virginia 23060 • 1-800-572-3331 (US) or + 1-910-963-4277  
[hamiltonbeachcommercial.com](http://hamiltonbeachcommercial.com)